

# NTMSD3P303R2

## FETKY™

### P-Channel Enhancement-Mode Power MOSFET and Schottky Diode Dual SO-8 Package

#### Features

- High Efficiency Components in a Single SO-8 Package
- High Density Power MOSFET with Low  $R_{DS(on)}$ , Schottky Diode with Low  $V_F$
- Independent Pin-Outs for MOSFET and Schottky Die Allowing for Flexibility in Application Use
- Less Component Placement for Board Space Savings
- SO-8 Surface Mount Package, Mounting Information for SO-8 Package Provided
- Pb-Free Package is Available

#### Applications

- DC-DC Converters
- Low Voltage Motor Control
- Power Management in Portable and Battery-Powered Products, i.e.: Computers, Printers, PCMCIA Cards, Cellular and Cordless Telephones

#### MOSFET MAXIMUM RATINGS ( $T_J = 25^\circ\text{C}$ unless otherwise noted)

Rating	Symbol	Value	Unit
Drain-to-Source Voltage	$V_{DSS}$	-30	V
Gate-to-Source Voltage - Continuous	$V_{GS}$	$\pm 20$	V
Thermal Resistance - Junction-to-Ambient (Note 1)	$R_{\theta JA}$	171	$^\circ\text{C}/\text{W}$
Total Power Dissipation @ $T_A = 25^\circ\text{C}$	$P_D$	0.73	W
Continuous Drain Current @ $T_A = 25^\circ\text{C}$	$I_D$	-2.34	A
Continuous Drain Current @ $T_A = 70^\circ\text{C}$	$I_D$	-1.87	A
Pulsed Drain Current (Note 4)	$I_{DM}$	-8.0	A
Thermal Resistance - Junction-to-Ambient (Note 2)	$R_{\theta JA}$	100	$^\circ\text{C}/\text{W}$
Total Power Dissipation @ $T_A = 25^\circ\text{C}$	$P_D$	1.25	W
Continuous Drain Current @ $T_A = 25^\circ\text{C}$	$I_D$	-3.05	A
Continuous Drain Current @ $T_A = 70^\circ\text{C}$	$I_D$	-2.44	A
Pulsed Drain Current (Note 4)	$I_{DM}$	-12	A
Thermal Resistance - Junction-to-Ambient (Note 3)	$R_{\theta JA}$	62.5	$^\circ\text{C}/\text{W}$
Total Power Dissipation @ $T_A = 25^\circ\text{C}$	$P_D$	2.0	W
Continuous Drain Current @ $T_A = 25^\circ\text{C}$	$I_D$	-3.86	A
Continuous Drain Current @ $T_A = 70^\circ\text{C}$	$I_D$	-3.10	A
Pulsed Drain Current (Note 4)	$I_{DM}$	-15	A
Operating and Storage Temperature Range	$T_J, T_{stg}$	-55 to +150	$^\circ\text{C}$
Single Pulse Drain-to-Source Avalanche Energy - Starting $T_J = 25^\circ\text{C}$ ( $V_{DD} = -30$ Vdc, $V_{GS} = -4.5$ Vdc, Peak $I_L = -7.5$ Apk, $L = 5$ mH, $R_G = 25 \Omega$ )	$E_{AS}$	140	mJ
Maximum Lead Temperature for Soldering Purposes, 1/8" from case for 10 seconds	$T_L$	260	$^\circ\text{C}$

Stresses exceeding Maximum Ratings may damage the device. Maximum Ratings are stress ratings only. Functional operation above the Recommended Operating Conditions is not implied. Extended exposure to stresses above the Recommended Operating Conditions may affect device reliability.

1. Minimum FR-4 or G-10 PCB, Steady State.
2. Mounted onto a 2" square FR-4 Board (1 in sq, 2 oz Cu 0.06" thick single sided), Steady State.
3. Mounted onto a 2" square FR-4 Board (1 in sq, 2 oz Cu 0.06" thick single sided),  $t \leq 10$  seconds.
4. Pulse Test: Pulse Width = 300  $\mu\text{s}$ , Duty Cycle = 2%.

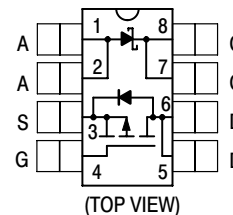


ON Semiconductor®

<http://onsemi.com>

**MOSFET**  
**-3.05 AMPERES**  
**-30 VOLTS**  
**0.085  $\Omega$  @  $V_{GS} = -10$  V**

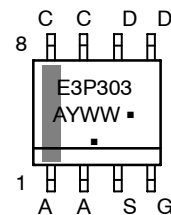
**SCHOTTKY DIODE**  
**3.0 AMPERES**  
**30 VOLTS**  
**420 mV @  $I_F = 3.0$  A**



#### MARKING DIAGRAM & PIN ASSIGNMENT



SO-8  
CASE 751  
STYLE 18



E3P303 = Device Code  
A = Assembly Location  
Y = Year  
WW = Work Week  
▪ = Pb-Free Package

(Note: Microdot may be in either location)

#### ORDERING INFORMATION

Device	Package	Shipping†
NTMSD3P303R2	SO-8	2500/Tape & Reel
NTMSD3P303R2G	SO-8 (Pb-Free)	2500/Tape & Reel

†For information on tape and reel specifications, including part orientation and tape sizes, please refer to our Tape and Reel Packaging Specification Brochure, BRD8011/D.

# NTMSD3P303R2

## SCHOTTKY MAXIMUM RATINGS ( $T_J = 25^\circ\text{C}$ unless otherwise noted)

Rating	Symbol	Value	Unit
Peak Repetitive Reverse Voltage DC Blocking Voltage	$V_{RRM}$ $V_R$	30	V
Thermal Resistance – Junction-to-Ambient (Note 5)	$R_{\theta JA}$	197	$^\circ\text{C/W}$
Thermal Resistance – Junction-to-Ambient (Note 6)	$R_{\theta JA}$	97	$^\circ\text{C/W}$
Thermal Resistance – Junction-to-Ambient (Note 7)	$R_{\theta JA}$	62.5	$^\circ\text{C/W}$
Average Forward Current (Note 7) (Rated $V_R$ , $T_A = 100^\circ\text{C}$ )	$I_O$	3.0	A
Peak Repetitive Forward Current (Note 7) (Rated $V_R$ , Square Wave, 20 kHz, $T_A = 105^\circ\text{C}$ )	$I_{FRM}$	6.0	A
Non-Repetitive Peak Surge Current (Note 7) (Surge Applied at Rated Load Conditions, Half-Wave, Single Phase, 60 Hz)	$I_{FSM}$	30	A

Stresses exceeding Maximum Ratings may damage the device. Maximum Ratings are stress ratings only. Functional operation above the Recommended Operating Conditions is not implied. Extended exposure to stresses above the Recommended Operating Conditions may affect device reliability.

5. Minimum FR-4 or G-10 PCB, Steady State.
6. Mounted onto a 2" square FR-4 Board (1 in sq, 2 oz Cu 0.06" thick single sided), Steady State.
7. Mounted onto a 2" square FR-4 Board (1 in sq, 2 oz Cu 0.06" thick single sided),  $t \leq 10$  seconds.

## ELECTRICAL CHARACTERISTICS ( $T_J = 25^\circ\text{C}$ unless otherwise noted) (Note 8)

Characteristic	Symbol	Min	Typ	Max	Unit
----------------	--------	-----	-----	-----	------

### OFF CHARACTERISTICS

Drain-to-Source Breakdown Voltage ( $V_{GS} = 0$ Vdc, $I_D = -250$ $\mu\text{Adc}$ ) Temperature Coefficient (Positive)	$V_{(BR)DSS}$	-30 -	- -30	- -	Vdc $\text{mV}/^\circ\text{C}$
Zero Gate Voltage Drain Current ( $V_{DS} = -30$ Vdc, $V_{GS} = 0$ Vdc, $T_J = 25^\circ\text{C}$ ) ( $V_{DS} = -30$ Vdc, $V_{GS} = 0$ Vdc, $T_J = 125^\circ\text{C}$ )	$I_{DSS}$	- -	- -	-1.0 -25	$\mu\text{Adc}$
Gate-Body Leakage Current ( $V_{GS} = -20$ Vdc, $V_{DS} = 0$ Vdc)	$I_{GSS}$	-	-	-100	nAdc
Gate-Body Leakage Current ( $V_{GS} = +20$ Vdc, $V_{DS} = 0$ Vdc)	$I_{GSS}$	-	-	100	nAdc

### ON CHARACTERISTICS

Gate Threshold Voltage ( $V_{DS} = V_{GS}$ , $I_D = -250$ $\mu\text{Adc}$ ) Temperature Coefficient (Negative)	$V_{GS(th)}$	-1.0 -	-1.7 3.6	-2.5 -	Vdc
Static Drain-to-Source On-State Resistance ( $V_{GS} = -10$ Vdc, $I_D = -3.05$ Adc) ( $V_{GS} = -4.5$ Vdc, $I_D = -1.5$ Adc)	$R_{DS(on)}$	- -	0.063 0.090	0.085 0.125	$\Omega$
Forward Transconductance ( $V_{DS} = -15$ Vdc, $I_D = -3.05$ Adc)	$g_{FS}$	-	5.0	-	Mhos

### DYNAMIC CHARACTERISTICS

Input Capacitance	$(V_{DS} = -24$ Vdc, $V_{GS} = 0$ Vdc, $f = 1.0$ MHz)	$C_{ISS}$	-	520	750	pF
Output Capacitance		$C_{OSS}$	-	170	325	
Reverse Transfer Capacitance		$C_{RSS}$	-	70	135	

8. Handling precautions to protect against electrostatic discharge are mandatory.

# NTMSD3P303R2

## MOSFET ELECTRICAL CHARACTERISTICS ( $T_J = 25^\circ\text{C}$ unless otherwise noted) (Note 9)

Characteristic	Symbol	Min	Typ	Max	Unit	
<b>SWITCHING CHARACTERISTICS</b> (Notes 10 & 11)						
Turn-On Delay Time	$(V_{DD} = -24\text{ Vdc},$ $I_D = -3.05\text{ Adc},$ $V_{GS} = -10\text{ Vdc},$ $R_G = 6.0\ \Omega)$	$t_{d(on)}$	-	12	22	ns
Rise Time		$t_r$	-	16	30	
Turn-Off Delay Time		$t_{d(off)}$	-	45	80	
Fall Time		$t_f$	-	45	80	
Turn-On Delay Time	$(V_{DD} = -24\text{ Vdc},$ $I_D = -1.5\text{ Adc},$ $V_{GS} = -4.5\text{ Vdc},$ $R_G = 6.0\ \Omega)$	$t_{d(on)}$	-	16	-	ns
Rise Time		$t_r$	-	42	-	
Turn-Off Delay Time		$t_{d(off)}$	-	32	-	
Fall Time		$t_f$	-	35	-	
Total Gate Charge	$(V_{DS} = -24\text{ Vdc},$ $V_{GS} = -10\text{ Vdc},$ $I_D = -3.05\text{ Adc})$	$Q_{tot}$	-	16	25	nC
Gate-Source Charge		$Q_{gs}$	-	2.0	-	
Gate-Drain Charge		$Q_{gd}$	-	4.5	-	

## BODY-DRAIN DIODE RATINGS (Note 10)

Diode Forward On-Voltage	$(I_S = -3.05\text{ Adc}, V_{GS} = 0\text{ Vdc})$ $(I_S = -3.05\text{ Adc}, V_{GS} = 0\text{ Vdc}, T_J = 125^\circ\text{C})$	$V_{SD}$	-	-0.96 -0.78	-1.25 -	Vdc
Reverse Recovery Time	$(I_S = -3.05\text{ Adc},$ $V_{GS} = 0\text{ Vdc},$ $dI_S/dt = 100\text{ A}/\mu\text{s})$	$t_{rr}$	-	34	-	ns
		$t_a$	-	18	-	
		$t_b$	-	16	-	
Reverse Recovery Stored Charge		$Q_{RR}$	-	0.03	-	$\mu\text{C}$

9. Handling precautions to protect against electrostatic discharge is mandatory.

10. Indicates Pulse Test: Pulse Width = 300  $\mu\text{s}$  max, Duty Cycle = 2%.

11. Switching characteristics are independent of operating junction temperature.

## SCHOTTKY RECTIFIER ELECTRICAL CHARACTERISTICS ( $T_J = 25^\circ\text{C}$ unless otherwise noted) (Note 12)

Maximum Instantaneous Forward Voltage	$I_F = 100\text{ mAdc}$ $I_F = 3.0\text{ Adc}$ $I_F = 6.0\text{ Adc}$	$V_F$	$T_J = 25^\circ\text{C}$	$T_J = 125^\circ\text{C}$	Volts
			0.28	0.13	Volts
			0.42	0.33	
Maximum Instantaneous Reverse Current	$V_R = 30\text{ Vdc}$	$I_R$	$T_J = 25^\circ\text{C}$	$T_J = 125^\circ\text{C}$	$\mu\text{A}$ mA
			250	25	
Maximum Voltage Rate of Change	$V_R = 30\text{ Vdc}$	$dV/dt$	10,000		$\text{V}/\mu\text{s}$

12. Indicates Pulse Test: Pulse Width = 300  $\mu\text{s}$  max, Duty Cycle = 2%.

TYPICAL MOSFET ELECTRICAL CHARACTERISTICS

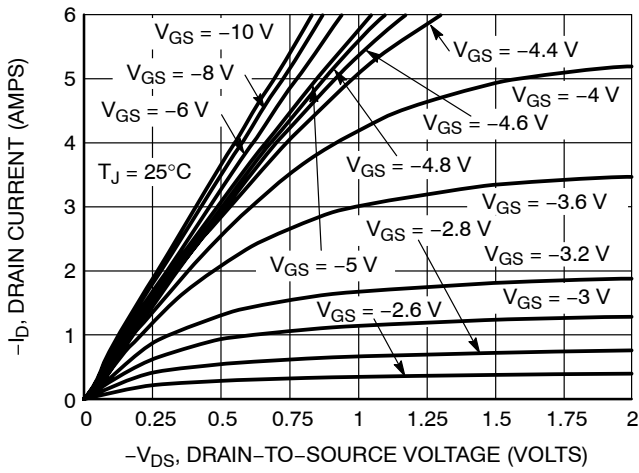


Figure 1. On-Region Characteristics

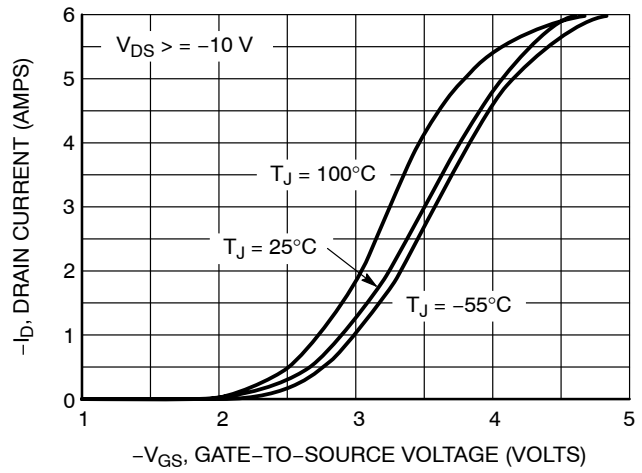


Figure 2. Transfer Characteristics

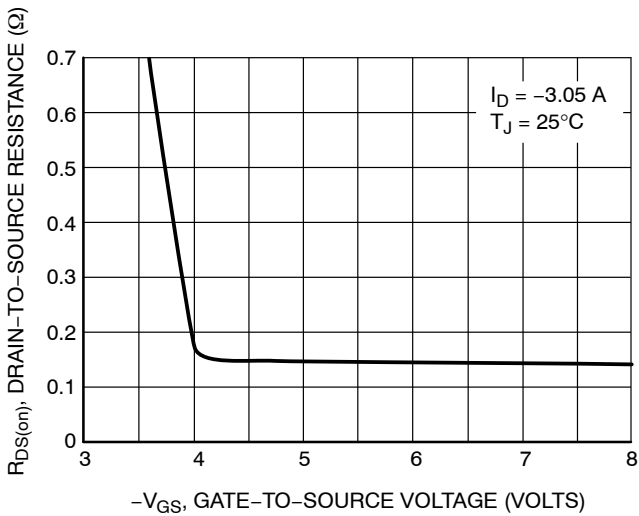


Figure 3. On-Resistance vs. Gate-to-Source Voltage

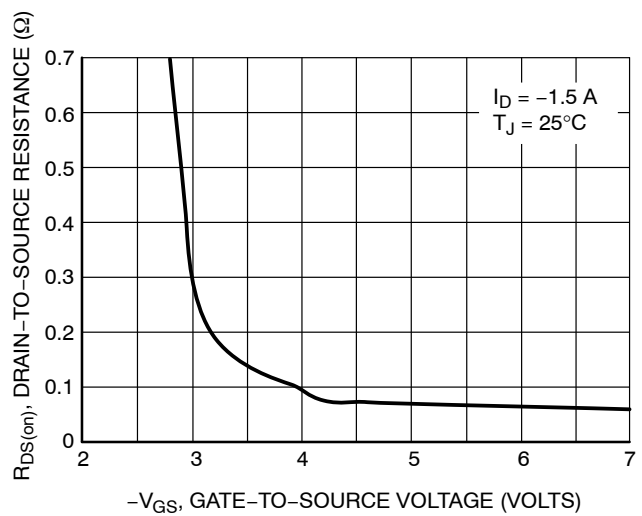


Figure 4. On-Resistance vs. Gate-to-Source Voltage

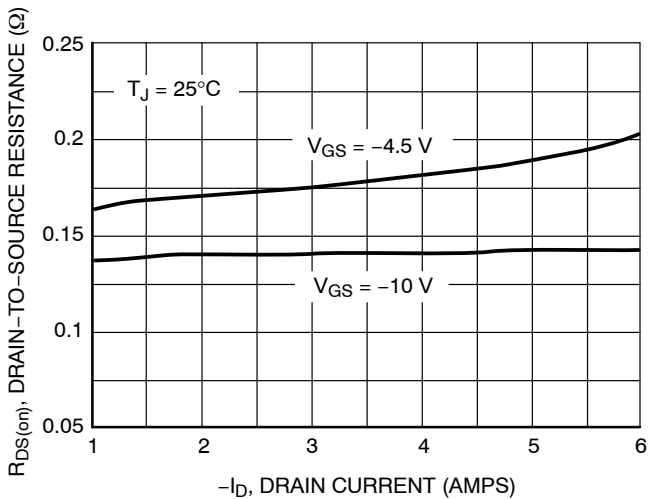


Figure 5. On-Resistance vs. Drain Current and Gate Voltage

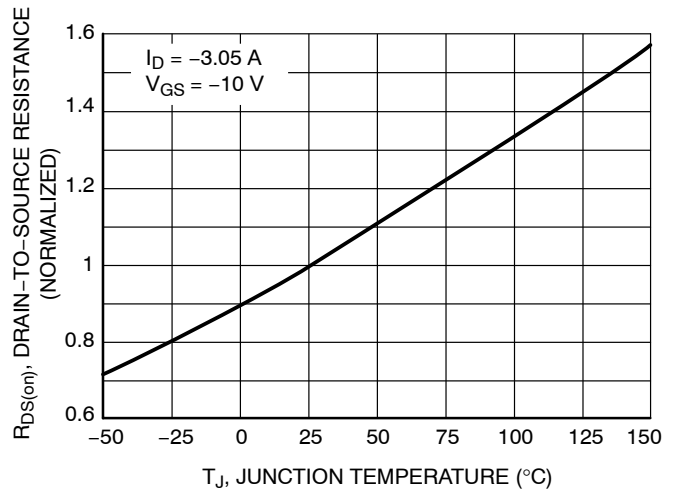
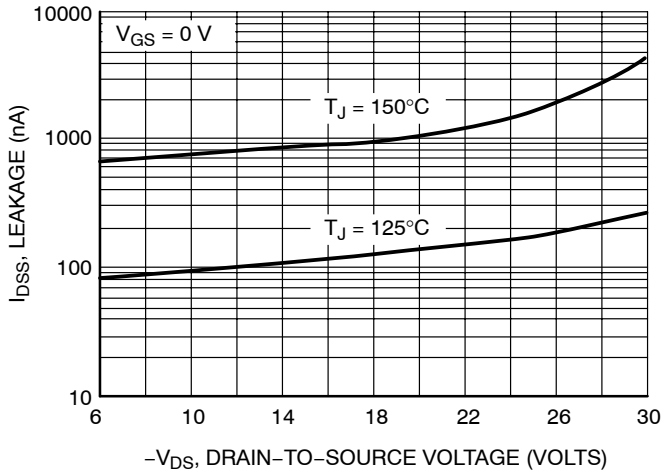
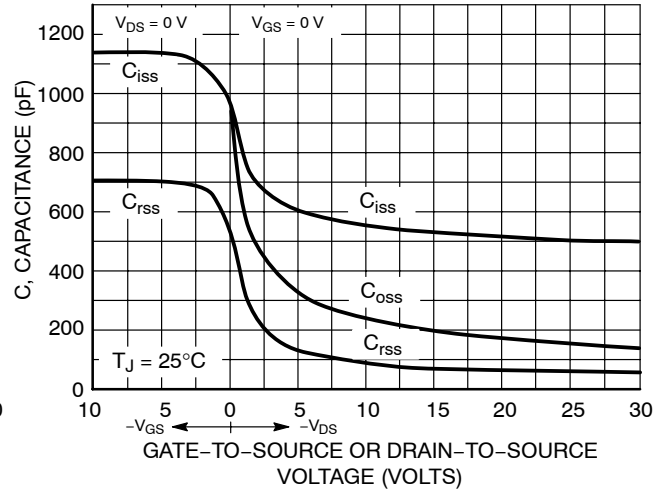


Figure 6. On Resistance Variation with Temperature

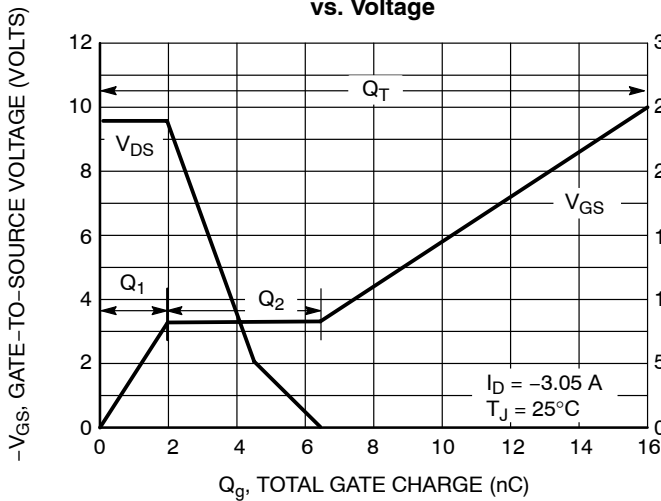
# NTMSD3P303R2



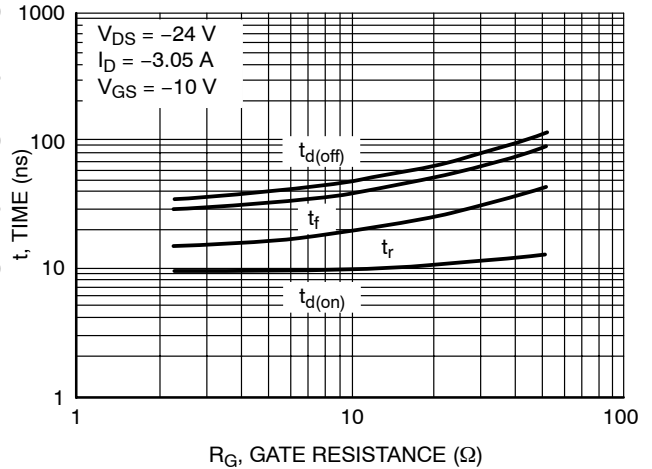
**Figure 7. Drain-to-Source Leakage Current vs. Voltage**



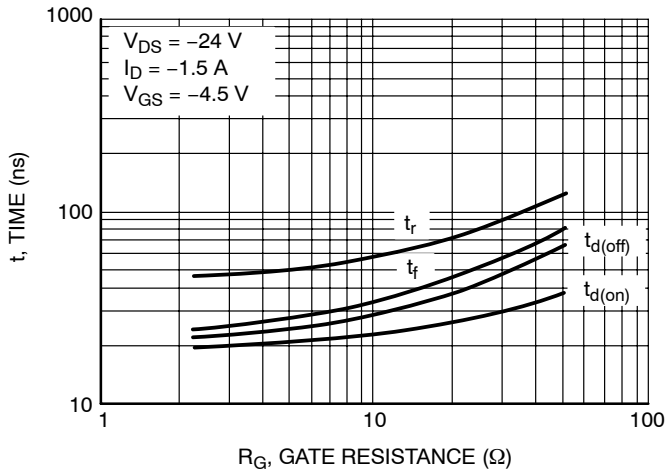
**Figure 8. Capacitance Variation**



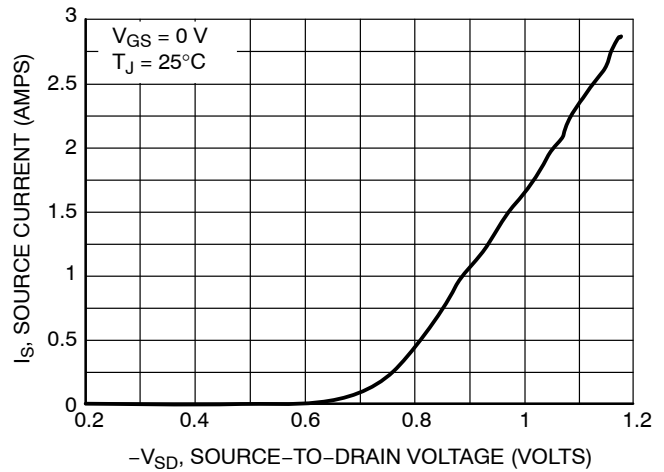
**Figure 9. Gate-to-Source and Drain-to-Source Voltage vs. Total Charge**



**Figure 10. Resistive Switching Time Variation vs. Gate Resistance**

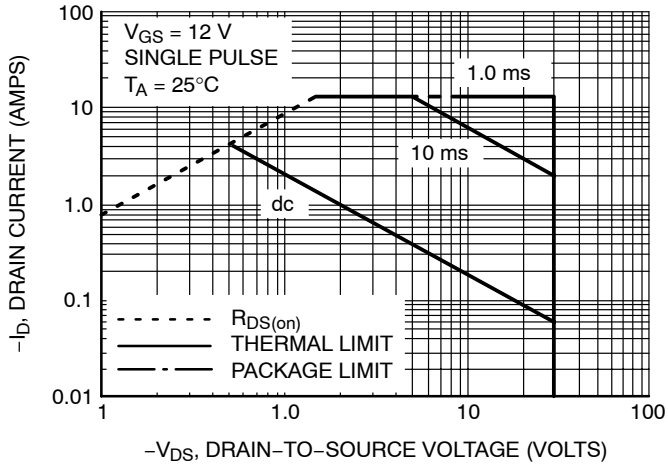


**Figure 11. Resistive Switching Time Variation vs. Gate Resistance**

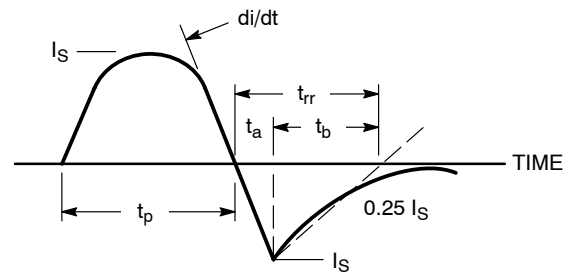


**Figure 12. Diode Forward Voltage vs. Current**

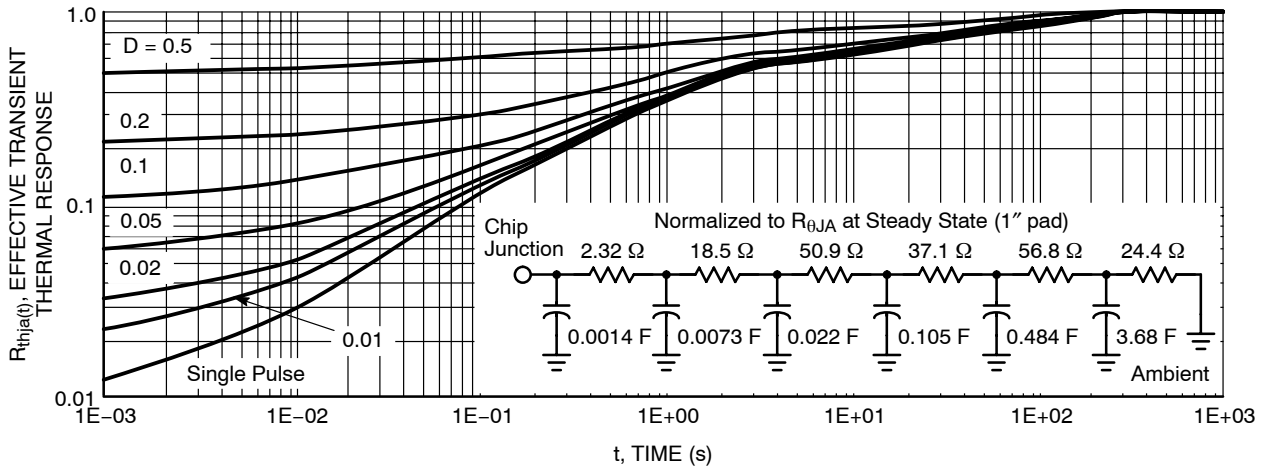
# NTMSD3P303R2



**Figure 13. Maximum Rated Forward Biased Safe Operating Area**



**Figure 14. Diode Reverse Recovery Waveform**



**Figure 15. FET Thermal Response**

TYPICAL SCHOTTKY ELECTRICAL CHARACTERISTICS

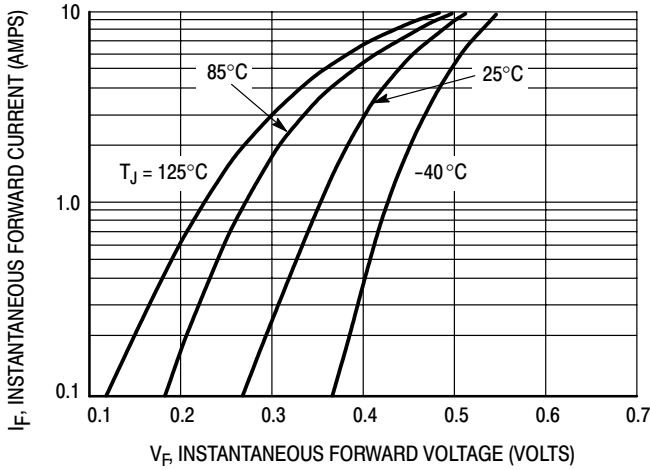


Figure 16. Typical Forward Voltage

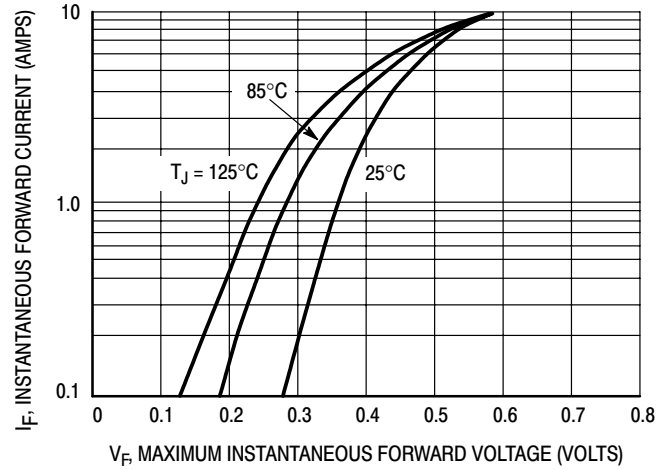


Figure 17. Maximum Forward Voltage

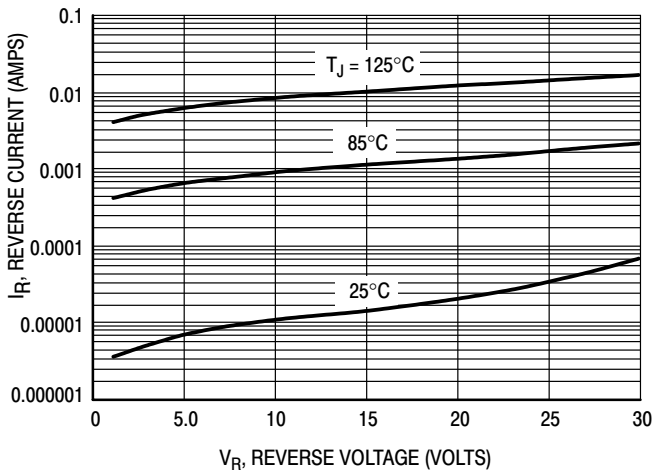


Figure 18. Typical Reverse Current

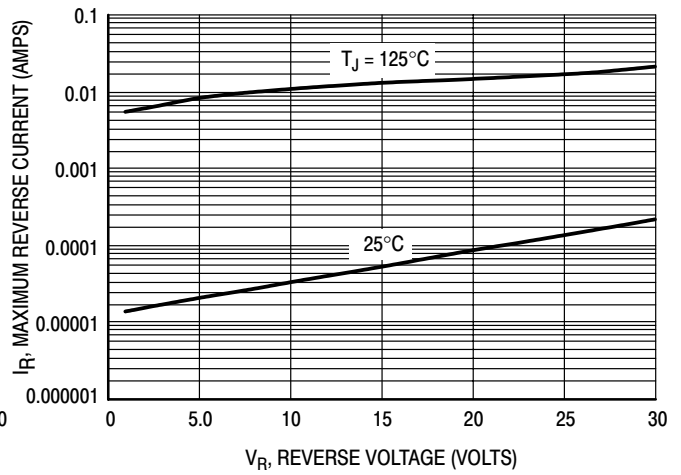


Figure 19. Maximum Reverse Current

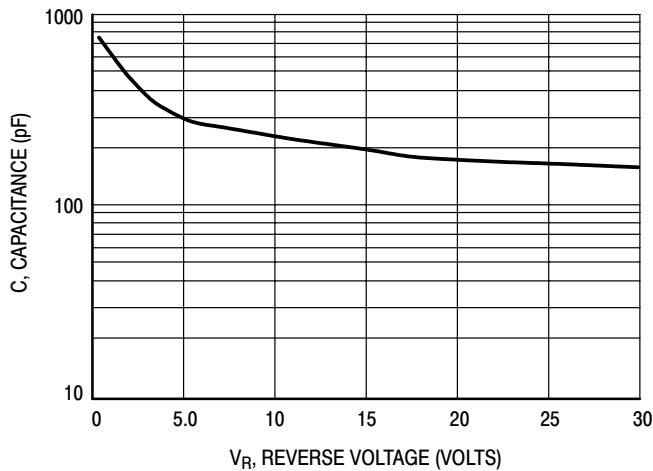


Figure 20. Typical Capacitance

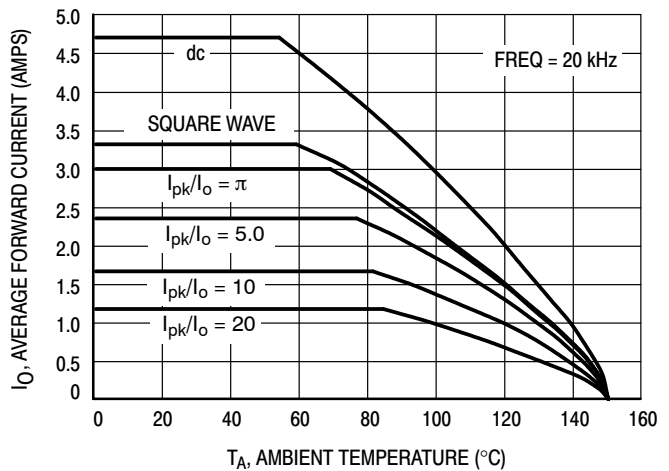


Figure 21. Current Derating

TYPICAL SCHOTTKY ELECTRICAL CHARACTERISTICS

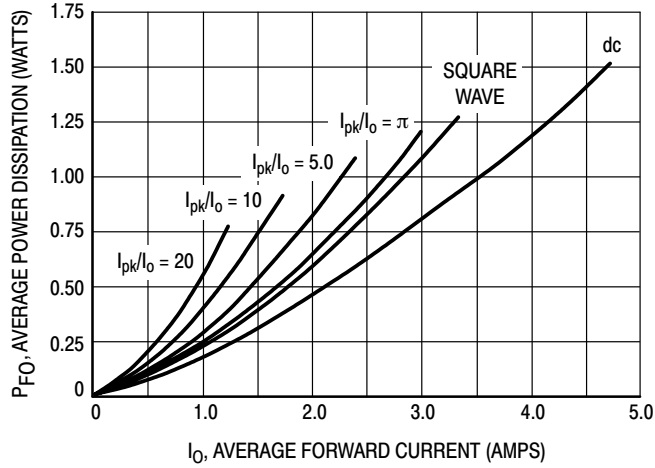


Figure 22. Forward Power Dissipation

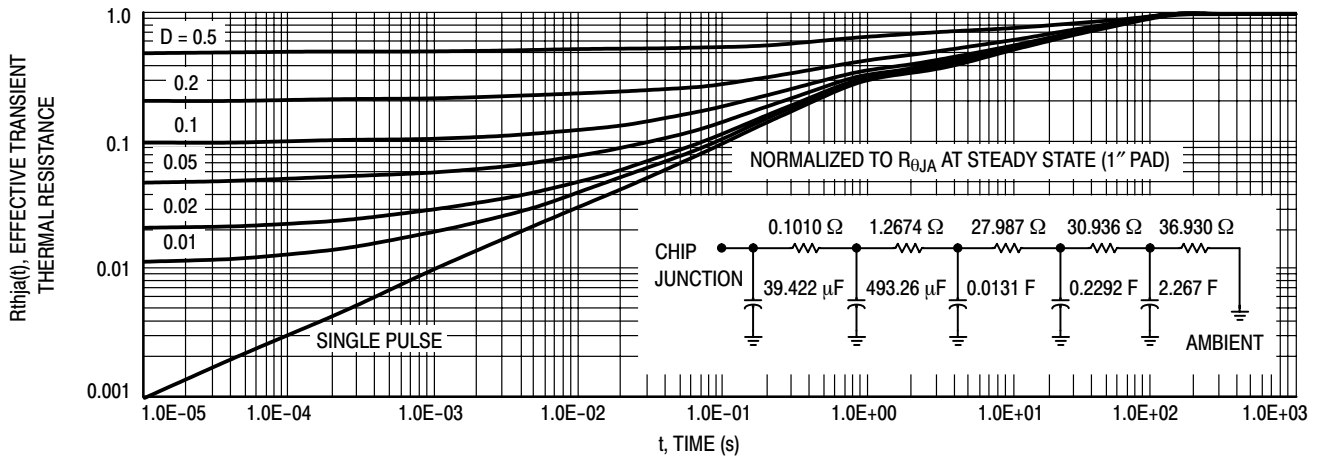


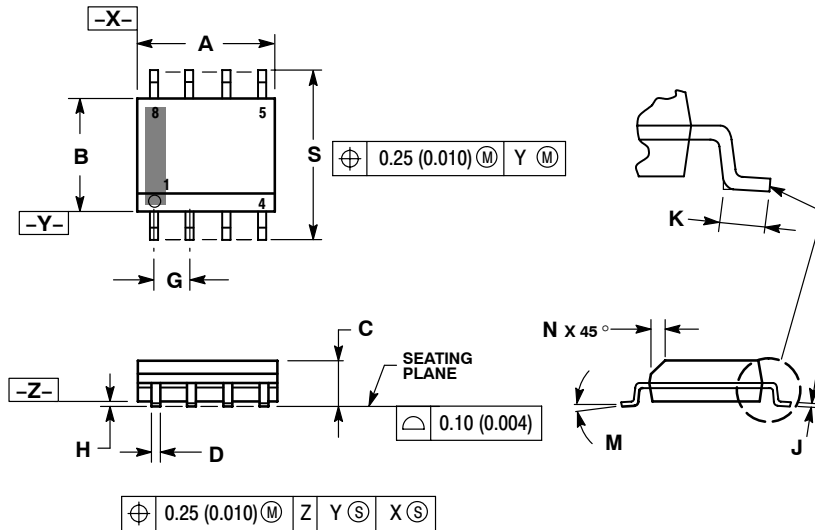
Figure 23. Schottky Thermal Response



# NTMSD3P303R2

## PACKAGE DIMENSIONS

SOIC-8 NB  
CASE 751-07  
ISSUE AG



**NOTES:**

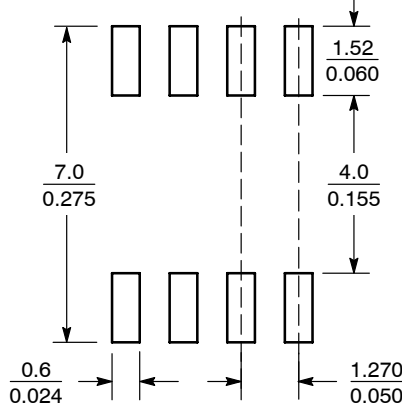
1. DIMENSIONING AND TOLERANCING PER ANSI Y14.5M, 1982.
2. CONTROLLING DIMENSION: MILLIMETER.
3. DIMENSION A AND B DO NOT INCLUDE MOLD PROTRUSION.
4. MAXIMUM MOLD PROTRUSION 0.15 (0.006) PER SIDE.
5. DIMENSION D DOES NOT INCLUDE DAMBAR PROTRUSION. ALLOWABLE DAMBAR PROTRUSION SHALL BE 0.127 (0.005) TOTAL IN EXCESS OF THE D DIMENSION AT MAXIMUM MATERIAL CONDITION.
6. 751-01 THRU 751-06 ARE OBSOLETE. NEW STANDARD IS 751-07.

DIM	MILLIMETERS		INCHES	
	MIN	MAX	MIN	MAX
A	4.80	5.00	0.189	0.197
B	3.80	4.00	0.150	0.157
C	1.35	1.75	0.053	0.069
D	0.33	0.51	0.013	0.020
G	1.27 BSC		0.050 BSC	
H	0.10	0.25	0.004	0.010
J	0.19	0.25	0.007	0.010
K	0.40	1.27	0.016	0.050
M	0°	8°	0°	8°
N	0.25	0.50	0.010	0.020
S	5.80	6.20	0.228	0.244

**STYLE 18:**

- PIN 1. ANODE  
2. ANODE  
3. SOURCE  
4. GATE  
5. DRAIN  
6. DRAIN  
7. CATHODE  
8. CATHODE

**SOLDERING FOOTPRINT\***



SCALE 6:1 (mm / inches)

\*For additional information on our Pb-Free strategy and soldering details, please download the ON Semiconductor Soldering and Mounting Techniques Reference Manual, SOLDERRM/D.

FETKY is a trademark of International Rectifier Corporation.

ON Semiconductor and are registered trademarks of Semiconductor Components Industries, LLC (SCILLC). SCILLC reserves the right to make changes without further notice to any products herein. SCILLC makes no warranty, representation or guarantee regarding the suitability of its products for any particular purpose, nor does SCILLC assume any liability arising out of the application or use of any product or circuit, and specifically disclaims any and all liability, including without limitation special, consequential or incidental damages. "Typical" parameters which may be provided in SCILLC data sheets and/or specifications can and do vary in different applications and actual performance may vary over time. All operating parameters, including "Typicals" must be validated for each customer application by customer's technical experts. SCILLC does not convey any license under its patent rights nor the rights of others. SCILLC products are not designed, intended, or authorized for use as components in systems intended for surgical implant into the body, or other applications intended to support or sustain life, or for any other application in which the failure of the SCILLC product could create a situation where personal injury or death may occur. Should Buyer purchase or use SCILLC products for any such unintended or unauthorized application, Buyer shall indemnify and hold SCILLC and its officers, employees, subsidiaries, affiliates, and distributors harmless against all claims, costs, damages, and expenses, and reasonable attorney fees arising out of, directly or indirectly, any claim of personal injury or death associated with such unintended or unauthorized use, even if such claim alleges that SCILLC was negligent regarding the design or manufacture of the part. SCILLC is an Equal Opportunity/Affirmative Action Employer. This literature is subject to all applicable copyright laws and is not for resale in any manner.

**PUBLICATION ORDERING INFORMATION**

**LITERATURE FULFILLMENT:**  
Literature Distribution Center for ON Semiconductor  
P.O. Box 61312, Phoenix, Arizona 85082-1312 USA  
**Phone:** 480-829-7710 or 800-344-3860 Toll Free USA/Canada  
**Fax:** 480-829-7709 or 800-344-3867 Toll Free USA/Canada  
**Email:** orderlit@onsemi.com

**N. American Technical Support:** 800-282-9855 Toll Free USA/Canada

**Japan:** ON Semiconductor, Japan Customer Focus Center  
2-9-1 Kamimeguro, Meguro-ku, Tokyo, Japan 153-0051  
**Phone:** 81-3-5773-3850

**ON Semiconductor Website:** <http://onsemi.com>

**Order Literature:** <http://www.onsemi.com/litorder>

For additional information, please contact your local Sales Representative.