

Low Phase Noise VCXO (9.5-65MHz)

FEATURES

- 19MHz to 65MHz fundamental crystal input.
- Output range: 9.5MHz – 65MHz
- Complementary outputs: PECL or LVDS output.
- Selectable OE Logic (enable high or enable low).
- Integrated variable capacitors.
- Supports 2.5V or 3.3V Power Supply.
- Available in 16 pin TSSOP package.

DESCRIPTION

The PLL520-88 (PECL) and PLL520-89 (LVDS) are VCXO ICs specifically designed to work with fundamental crystals between 19MHz and 65MHz. The selectable divide by two feature extends the operation range from 9.5MHz to 65MHz. They require very low current into the crystal resulting in better overall stability. The OE logic feature allows selection of enable high or enable low.

BLOCK DIAGRAM

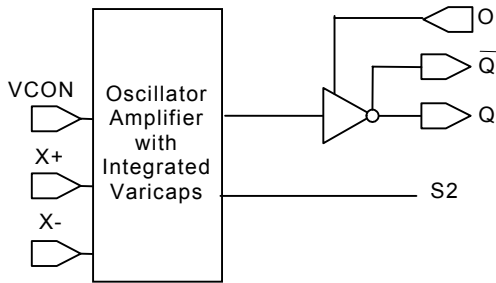

PLL520-8X Block Diagram

PIN CONFIGURATION

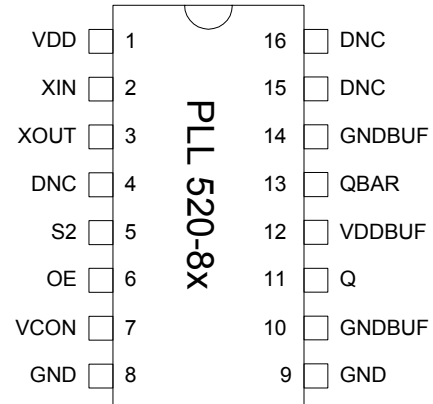

OUTPUT SELECTION AND ENABLE

OE_SELECT	OE_CTRL	State
0	0	Tri-state
	1 (Default)	Output enabled
1 (Default)	0 (Default)	Output enabled
	1	Tri-state

Input selection: Bond to GND to set to "0", bond to VDD to set to "1"
No connection results to "default" setting through internal pull-up/-down.

OE_CTRL: Logical states defined by PECL levels if OE_SELECT is "1"
Logical states defined by CMOS levels if OE_SELECT is "0"

OUTPUT FREQUENCY DIVIDE BY TWO SELECTOR

S2	Output
0	Input/2
1	Input

Low Phase Noise VCXO (9.5-65MHz)
PIN AND PAD ASSIGNMENT

Name	Pin#	Description
VDD	1	Power Supply.
XIN	2	Crystal input. See Crystal Specification on page 3.
XOUT	3	Crystal output. See Crystal Specification on page 3.
DNC	4	Do Not Connect.
S2	5	Output Divide by Two selector pin. See the OUTPUT DIVIDE BY TWO SELECTOR Table on page 1.
OE_CTRL	6	Output Enable input. See OUTPUT SELECTION AND ENABLE TABLE on page 1.
VCON	8	Voltage control input.
GND	9	Ground.
GNDBUF	10	Ground for output buffer circuitry.
Q	11	PECL or LVDS output.
VDDBUF	12	Power supply for output buffer circuitry.
QBAR	13	Complementary PECL or LVDS output.
GNDBUF	14	Ground for output buffer circuitry.
DNC	15	Do Not Connect.
DNC	16	Do Not Connect.

ELECTRICAL SPECIFICATIONS
1. Absolute Maximum Ratings

PARAMETERS	SYMBOL	MIN.	MAX.	UNITS
Supply Voltage	V_{DD}		4.6	V
Input Voltage, dc	V_I	-0.5	$V_{DD}+0.5$	V
Output Voltage, dc	V_O	-0.5	$V_{DD}+0.5$	V
Storage Temperature	T_S	-65	150	°C
Ambient Operating Temperature*	T_A	-40	85	°C
Junction Temperature	T_J		125	°C
Lead Temperature (soldering, 10s)			260	°C
ESD Protection, Human Body Model			2	kV

Exposure of the device under conditions beyond the limits specified by Maximum Ratings for extended periods may cause permanent damage to the device and affect product reliability. These conditions represent a stress rating only, and functional operations of the device at these or any other conditions above the operational limits noted in this specification is not implied.

* **Note:** Operating Temperature is guaranteed by design for all parts (COMMERCIAL and INDUSTRIAL), but tested for COMMERCIAL grade only.

Low Phase Noise VCXO (9.5-65MHz)
2. Crystal Specifications

PARAMETERS	SYMBOL	CONDITIONS	MIN.	TYP.	MAX.	UNITS
Crystal Resonator Frequency	F_{XIN}	Fundamental	19		65	MHz
Crystal Loading Rating	$C_{L(xtal)}$	Die		8*		pF
Interelectrode Capacitance	C_0				5	pF
Recommended ESR	R_E	AT cut			30	Ω

Note: Parameters denoted with an asterisk (*) represent nominal characterization data and are not production tested to any specific limits.

3. Voltage Control Crystal Oscillator (3.3V)

PARAMETERS	SYMBOL	CONDITIONS	MIN.	TYP.	MAX.	UNITS
VCXO Stabilization Time *	$T_{VCXOSTB}$	From power valid			10	ms
VCXO Tuning Range		$F_{XIN} = 19 - 65\text{MHz};$ XTAL $C_0/C_1 < 250$ $0V \leq VCON \leq 3.3V$		200*		ppm
CLK output pullability		$VCON = 1.65V, \pm 1.65V$	$\pm 100^*$			ppm
On-chip Varicaps control range		$VCON = 0 \text{ to } 3.3V$		4 - 18*		pF
Linearity					10*	%
VCXO Tuning Characteristic				65		ppm/V
VCON input impedance				60		k Ω
VCON modulation BW		$0V \leq VCON \leq 3.3V, -3\text{dB}$	25			kHz

Note: Parameters denoted with an asterisk (*) represent nominal characterization data and are not production tested to any specific limits.

4. General Electrical Specifications

PARAMETERS	SYMBOL	CONDITIONS	MIN.	TYP.	MAX.	UNITS
Supply Current (Loaded Outputs)	I_{DD}	PECL/LVDS			100/80	mA
Operating Voltage	V_{DD}		2.97		3.63	V
Output Clock Duty Cycle		@ 50% V_{DD} (CMOS) @ 1.25V (LVDS) @ $V_{DD} - 1.3V$ (PECL)	45 45 45	50 50 50	55 55 55	%
Short Circuit Current				± 50		mA

Low Phase Noise VCXO (9.5-65MHz)

5. Jitter Specifications

PARAMETERS	CONDITIONS	MIN.	TYP.	MAX.	UNITS
Period jitter RMS at 27MHz	With capacitive decoupling between VDD and GND. Over 10,000 cycles		2.3		ps
Period jitter peak-to-peak at 27MHz			18.5	20	
Accumulated jitter RMS at 27MHz	With capacitive decoupling between VDD and GND. Over 1,000,000 cycles.		2.3		ps
Accumulated jitter peak-to-peak at 27MHz			24	25	
Random Jitter	"RJ" measured on Wavecrest SIA 3000		2.3		ps

Measured on Wavecrest SIA 3000

6. Phase Noise Specifications

PARAMETERS	FREQUENCY	@10Hz	@100Hz	@1kHz	@10kHz	@100kHz	UNITS
Phase Noise relative to carrier	27MHz	-75	-100	-125	-140	-145	dBc/Hz

Note: Phase Noise measured on Agilent E5500

Low Phase Noise VCXO (9.5-65MHz)

7. LVDS Electrical Characteristics

PARAMETERS	SYMBOL	CONDITIONS	MIN.	TYP.	MAX.	UNITS
Output Differential Voltage	V_{OD}	$R_L = 100 \Omega$ (see figure)	247	355	454	mV
V_{DD} Magnitude Change	ΔV_{OD}		-50		50	mV
Output High Voltage	V_{OH}			1.4	1.6	V
Output Low Voltage	V_{OL}		0.9	1.1		V
Offset Voltage	V_{OS}		1.125	1.2	1.375	V
Offset Magnitude Change	ΔV_{OS}		0	3	25	mV
Power-off Leakage	I_{OXD}	$V_{out} = V_{DD}$ or GND $V_{DD} = 0V$		± 1	± 10	μA
Output Short Circuit Current	I_{OSD}			-5.7	-8	mA

8. LVDS Switching Characteristics

PARAMETERS	SYMBOL	CONDITIONS	MIN.	TYP.	MAX.	UNITS
Differential Clock Rise Time	t_r	$R_L = 100 \Omega$ $C_L = 10 \text{ pF}$ (see figure)	0.2	0.7	1.0	ns
Differential Clock Fall Time	t_f		0.2	0.7	1.0	ns

LVDS Levels Test Circuit

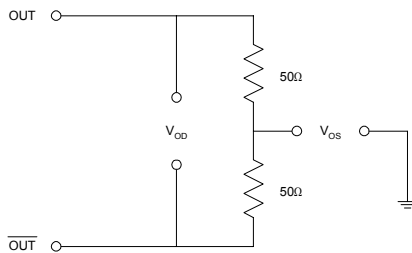

LVDS Switching Test Circuit

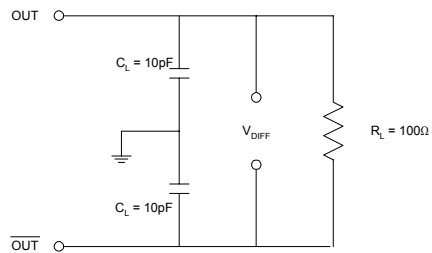

LVDS Transition Time Waveform

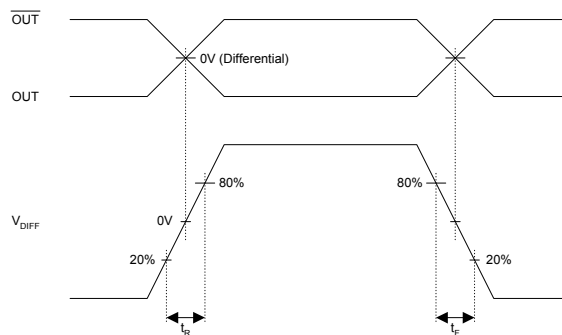

Low Phase Noise VCXO (9.5-65MHz)

9. PECL Electrical Characteristics

PARAMETERS	SYMBOL	CONDITIONS	MIN.	MAX.	UNITS
Output High Voltage	V_{OH}	$R_L = 50 \Omega$ to $(V_{DD} - 2V)$ (see figure)	$V_{DD} - 1.025$		V
Output Low Voltage	V_{OL}			$V_{DD} - 1.620$	V

11. PECL Switching Characteristics

PARAMETERS	SYMBOL	CONDITIONS	MIN.	TYP.	MAX.	UNITS
Clock Rise Time	t_r	@20/80% - PECL		0.6	1.5	ns
Clock Fall Time	t_f	@80/20% - PECL		0.5	1.5	ns

PECL Levels Test Circuit

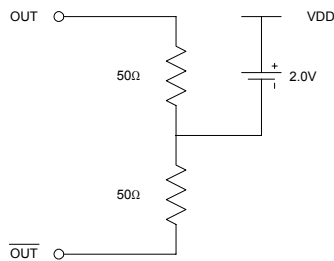

PECL Output Skew

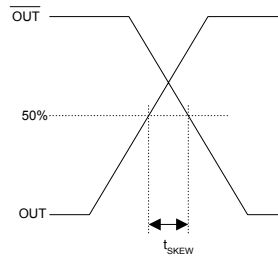

PECL Transition Time Waveform

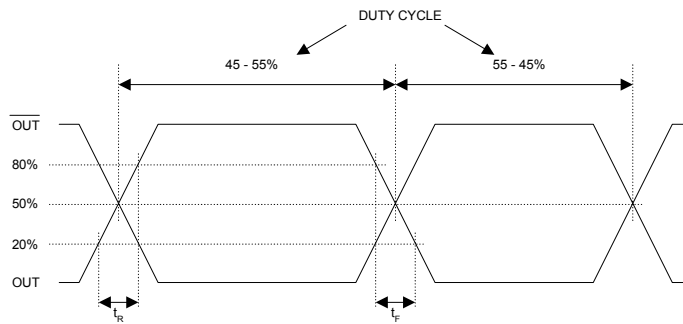

Low Phase Noise VCXO (9.5-65MHz)

PACKAGE INFORMATION

16 PIN TSSOP (mm)		
Symbol	Min.	Max.
A	-	1.20
A1	0.05	0.15
B	0.19	0.30
C	0.09	0.20
D	4.90	5.10
E	4.30	4.50
H	6.40 BSC	
L	0.45	0.75
e	0.65 BSC	

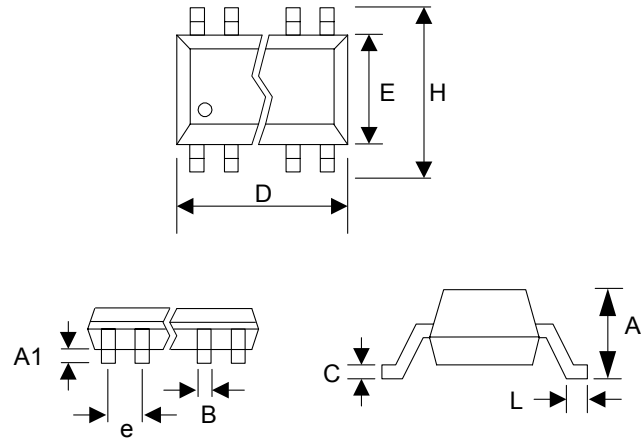

ORDERING INFORMATION

For part ordering, please contact our Sales Department:

47745 Fremont Blvd., Fremont, CA 94538, USA

Tel: (510) 492-0990 Fax: (510) 492-0991

PART NUMBER

The order number for this device is a combination of the following:
Device number, Package type and Operating temperature range

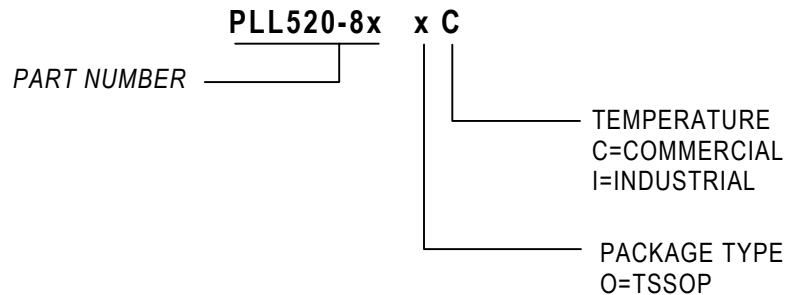

<u>Order Number</u>	<u>Marking</u>	<u>Package Option</u>
PLL520-88OC-R	P520-88 OC	TSSOP – Tape and Reel
PLL520-88OC	P520-88 OC	TSSOP – Tube
PLL520-89OC-R	P520-89 OC	TSSOP – Tape and Reel
PLL520-89OC	P520-89 OC	TSSOP – Tube

PhaseLink Corporation, reserves the right to make changes in its products or specifications, or both at any time without notice. The information furnished by Phaselink is believed to be accurate and reliable. However, PhaseLink makes no guarantee or warranty concerning the accuracy of said information and shall not be responsible for any loss or damage of whatever nature resulting from the use of, or reliance upon this product.

LIFE SUPPORT POLICY: PhaseLink's products are not authorized for use as critical components in life support devices or systems without the express written approval of the President of PhaseLink Corporation.