

PD480PI/PD480PI1

High Speed, Narrow Acceptance Photodiodes

■ Features

1. High speed response (t_r, t_f : TYP. 100ns at $R_L = 1k\Omega$)
2. Narrow acceptance ($\Delta\theta$: TYP. $\pm 20^\circ$)
3. Compact
4. Lead forming type (**PD480PI1**)

■ Applications

1. Game machines
2. Optoelectronic switches
3. Infrared remote controllers for TVs, VCRs, audio equipment, air conditioners, etc.

■ Absolute Maximum Ratings (Ta = 25°C)

Parameter	Symbol	Rating	Unit
Reverse voltage	V_R	20	V
Power dissipation	P	75	mW
Operating temperature	T_{opr}	-25 to +85	°C
Storage temperature	T_{stg}	-40 to +85	°C
*1 Soldering temperature	T_{sol}	260	°C

*1 For 3 seconds at the position of 2.5mm from the surface of resin edge

■ Electro-optical Characteristics (Ta = 25°C)

Parameter	Symbol	Conditions	MIN.	TYP.	MAX.	Unit
*2 Short circuit current	I_{sc}	$E_v = 100 \text{ lx}$	1.0	1.7	2.4	μA
Dark current	I_d	$V_R = 10\text{V}, E_v = 0$	-	-	10	nA
Terminal capacitance	C_t	$V_R = 0, f = 1\text{MHz}$	-	4.0	10	pF
Peak sensitivity wavelength	λ_p	-	-	950	-	nm
Response time	t_r, t_f	$R_L = 1k\Omega, V_R = 10\text{V}$	-	100	250	ns
Half intensity angle	$\Delta\theta$	-	-	± 20	-	°

*2 E_v : Illuminance by CIE standard light source A (tungsten lamp)

■ Outline Dimensions

(Unit: mm)

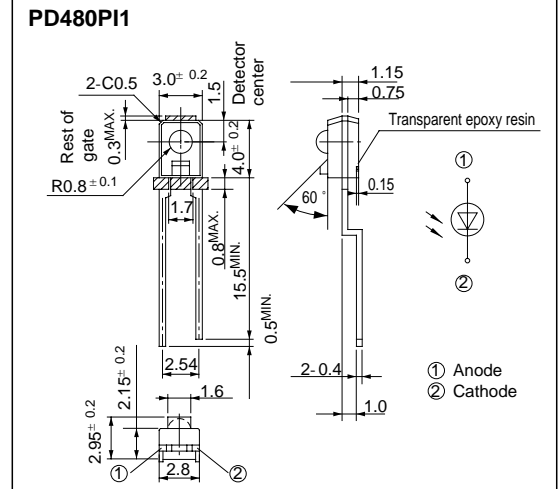
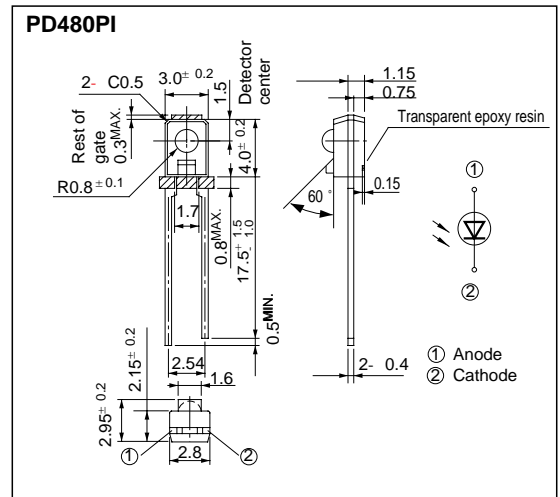

Fig. 1 Power Dissipation vs. Ambient Temperature

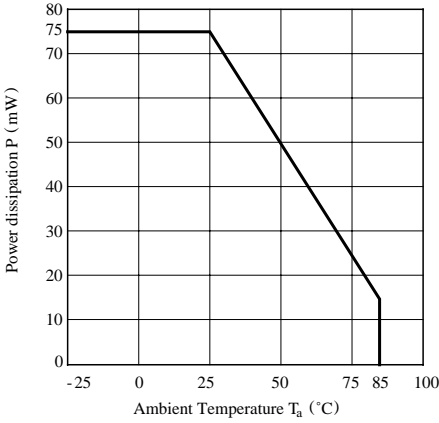

Fig. 2 Spectral Sensitivity

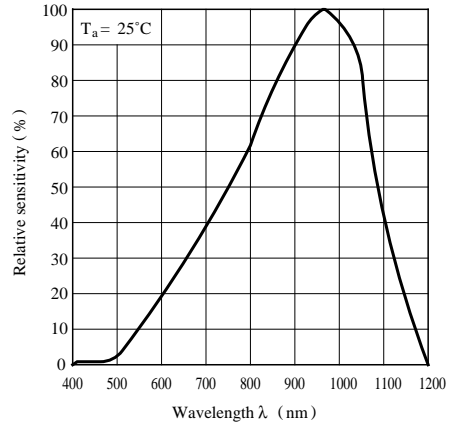

Fig. 3 Dark Current vs. Ambient Temperature

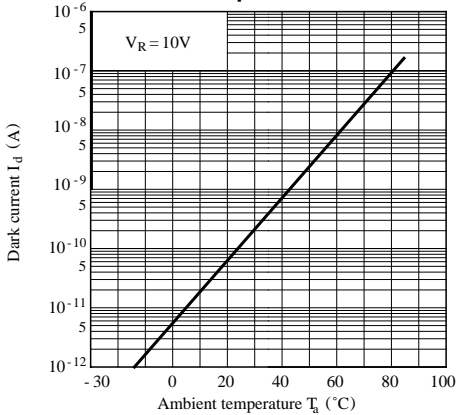

Fig. 4 Dark Current vs. Reverse Voltage

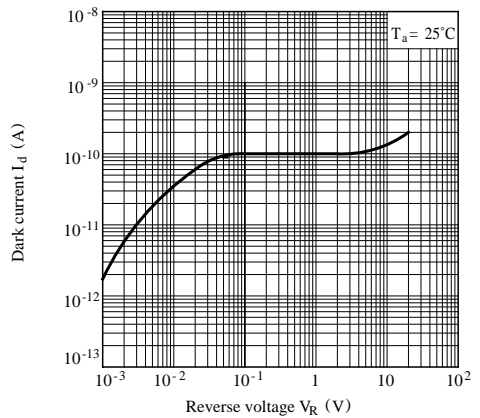

Fig. 5 Terminal Capacitance vs. Reverse Voltage

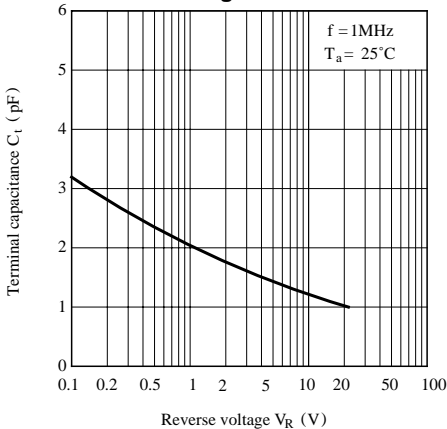

Fig. 6 Relative Output vs. Ambient Temperature

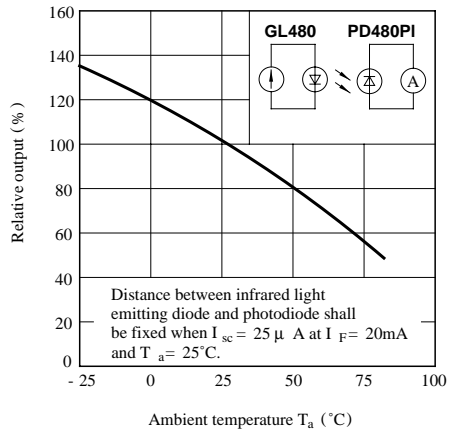

Fig. 7 Sensitivity Diagram (T_a = 25°C)

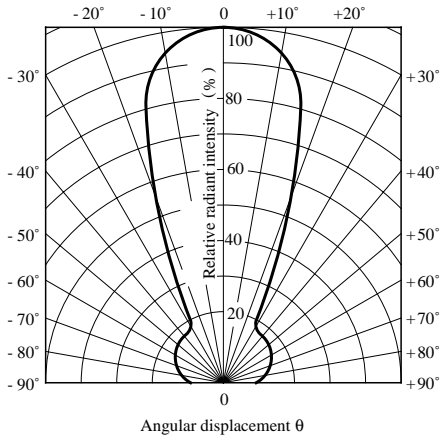

Fig. 8 Relative Output vs. Distance

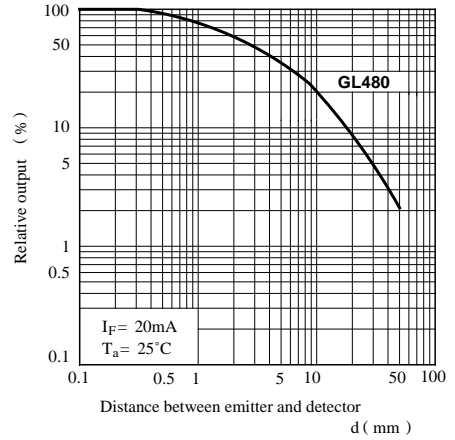
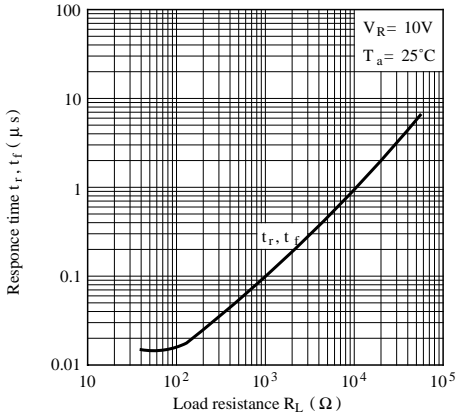
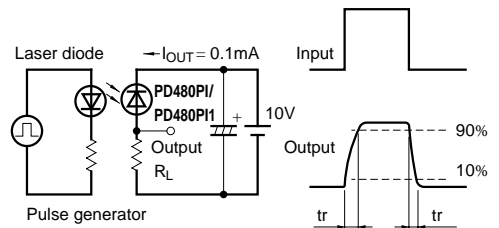

Fig. 9 Response Time vs. Load Resistance



Test Circuit for Response Time



● Please refer to the chapter “Precautions for Use.”