

PE83512

Military Operating Temperature Range

Product Description

The PE83512 is a high-performance static CMOS prescaler with a fixed divide ratio of 4. Its operating frequency range is DC to 1500 MHz. The PE83512 operates on a nominal 3 V supply and draws only 14mA. It is packaged in a small 8-lead plastic MSOP and is ideal for frequency scaling and clock generation solutions.

The PE83512 is manufactured in Peregrine's patented Ultra-Thin Silicon (UTSi[®]) CMOS process, offering the performance of GaAs with the economy and integration of conventional CMOS.

DC - 1500 MHz Low Power
 CMOS Divide-by-4 Prescaler

Features

- DC to 1500 MHz operation
- Fixed divide ratio of 4
- Low-power operation: 14mA typical @ 3.0 V
- Ultra small package: 8-lead plastic MSOP

Figure 1. Functional Schematic Diagram

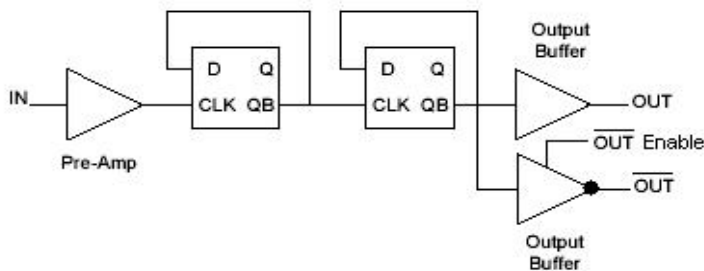

Figure 2. Package Type

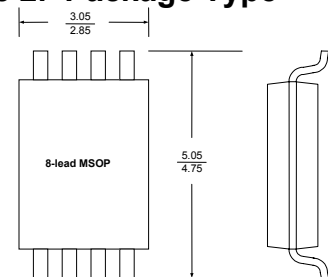
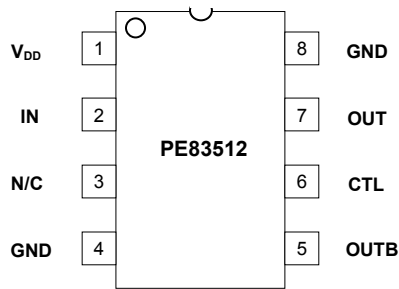

Table 1. Electrical Specifications ($Z_S = Z_L = 50 \Omega$)

$2.85V \leq V_{DD} \leq 3.15V$; $-55^\circ C \leq T_A \leq 125^\circ C$, unless otherwise specified

Parameter	Conditions	Minimum	Typical	Maximum	Units
Supply Voltage		2.85	3.0	3.15	V
Supply Current ¹	OUTB Disabled		7	12	mA
	OUTB Enabled		14	25	mA
Input Frequency (F_{IN})		DC		1500	MHz
Input Power (P_{IN})	$100 \text{ MHz} \leq F_{in} \leq 1200 \text{ MHz}$ $-55^\circ C \leq T_A \leq 85^\circ C$	-5		+10	dBm
	$100 \text{ MHz} \leq F_{in} \leq 1200 \text{ MHz}$ $85^\circ C \geq T_A \geq 125^\circ C$	0		+10	dBm
	$1200 \text{ MHz} < F_{in} \leq 1500 \text{ MHz}$ $-55^\circ C \leq T_A \leq 85^\circ C$	+5		+10	dBm
Output Power	$DC < F_{in} \leq 1500 \text{ MHz}$	+2			dBm

Figure 3. Pin Configuration

Table 2. Pin Descriptions

Pin No.	Pin Name	Description
1	V _{DD}	Power supply pin. Bypassing is required (eg 1000 pF & 100 pF).
2	IN	Input signal pin. Should be coupled with a capacitor (eg 1000 pF).
3	N/C	No connection. This pin should be left open.
4	GND	Ground pin. Ground pattern on the board should be as wide as possible to reduce ground impedance.
5	OUTB	Inverted divided frequency output. This pin should be coupled with a capacitor (eg 1000 pF).
6	CTL	Control pin. When grounded OUTB is enabled.
7	OUT	Divided frequency output pin. This pin should be coupled with a capacitor (eg 1000 pF).
8	GND	Ground Pin.

Table 3. Absolute Maximum Ratings

Symbol	Parameter/Conditions	Min	Max	Units
V _{DD}	Supply voltage		4.0	V
P _{in}	Input Power		15	dBm
V _{IN}	Voltage on input	-0.3	V _{DD} +0.3	V
T _{ST}	Storage temperature range	-65	150	°C
T _{OP}	Operating temperature range	-55	125	°C
VESD	ESD voltage (Human Body Model, MIL-STD 883)		2000	V

Electrostatic Discharge (ESD) Precautions

When handling this *UTSi*[®] device, observe the same precautions that you would use with other ESD-sensitive devices. Although this device contains circuitry to protect it from damage due to ESD, precautions should be taken to avoid exceeding the rating specified in Table 3.

Latch-Up Avoidance

Unlike conventional CMOS devices, *UTSi*[®] CMOS devices are immune to latch-up.

Device Functional Considerations

The *PE83512* divides an input signal, up to a frequency of 1500 MHz, by a factor of four thereby producing an output frequency at one fourth the input frequency. To work properly at higher frequency, the input and output signals (pins 2, 7 & optional 5) must be AC coupled via an external capacitor, as shown in the test circuit in Figure 4. The input may be DC coupled for low frequency operation with care taken to remain within the specified DC input range for the device.

The ground pattern on the board should be made as wide as possible to minimize ground impedance. See Figure 7 for a layout example.

OUTB Control

Pin 6 controls whether OUTB is enabled or disabled. Pin 6 has an internal pull-up resistor. With no connection (floating), OUTB is disabled. By grounding pin 6, OUTB is enabled. By enabling OUTB, this part will use roughly 5 mA more current.

Typical Performance Data: $V_{DD} = 3.0V$

Figure 4. Input Sensitivity

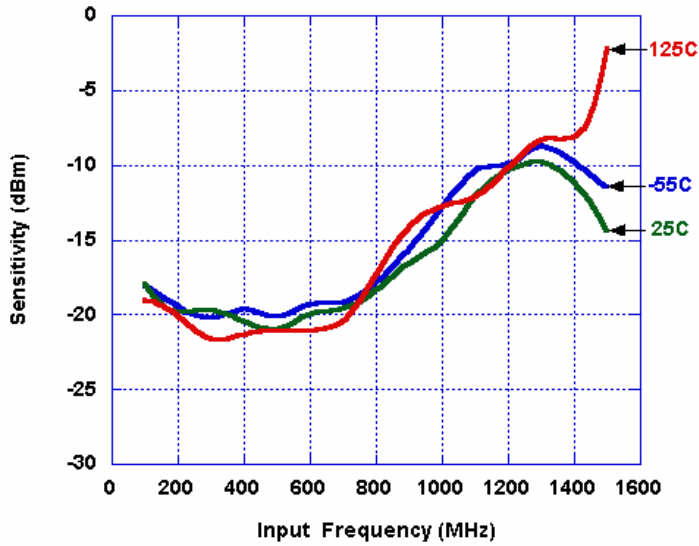

Figure 5. Device Current (OUTB Enabled)

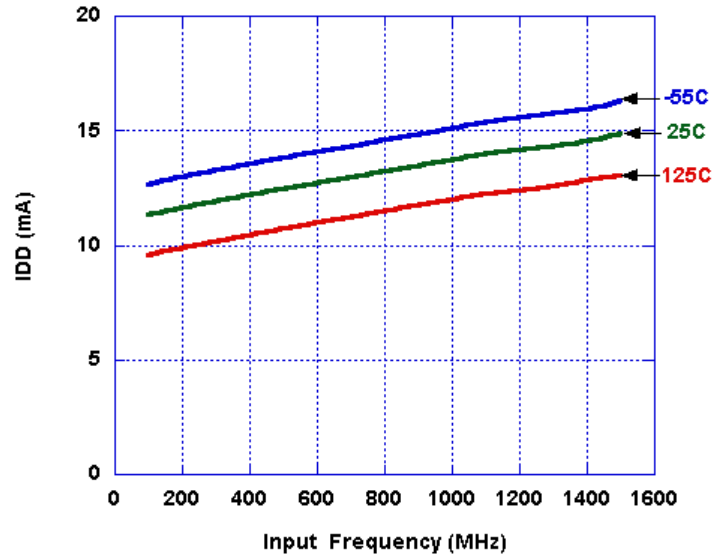

Figure 6. Output Power (OUT or OUTB)

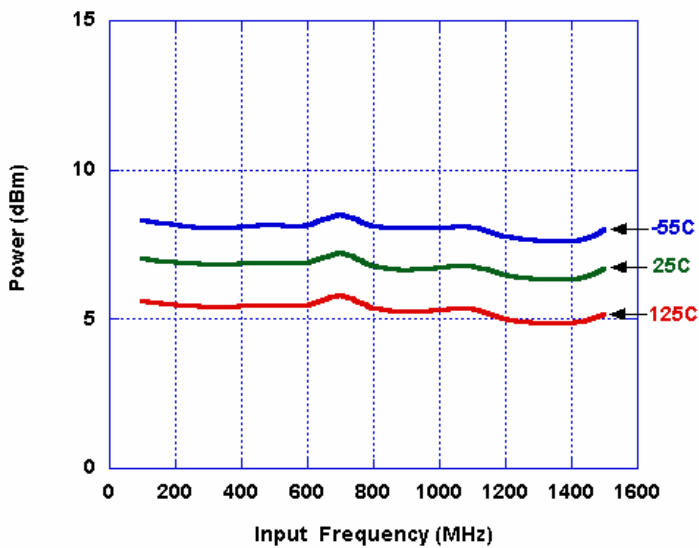
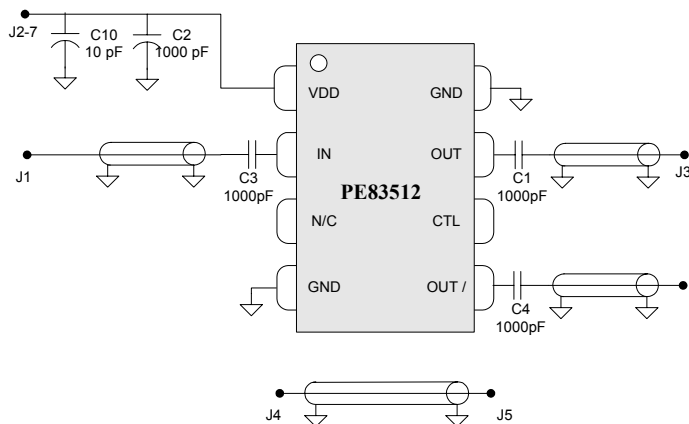

Figure 7. Evaluation Board Schematic Diagram

Evaluation Kit Operation

The PE83512 EK board was designed to ease customer evaluation of Peregrine's high performance Military Grade divide-by-4 Prescaler. On this board, the device input (pin 2) is connected via J1 and a 50 Ω transmission line. A series capacitor (C3) provides the necessary DC block for the device input. It is important to note that the value of this capacitance will impact the performance of the device. A value of 1000 pF was found to be optimal for this board layout; other applications may require a different value.

The device output (pin 7) is connected to connector J3 through a 50 Ω transmission line. A series capacitor (C1) provides the necessary DC block for the device output. Note that this capacitor must be chosen to have low impedance at the desired output frequency the device. The value of 1000pF was chosen to provide a wide operating range for the evaluation board.

The board is constructed of a two-layer FR4 material with a total thickness of 0.031". The bottom layer provides ground for the RF

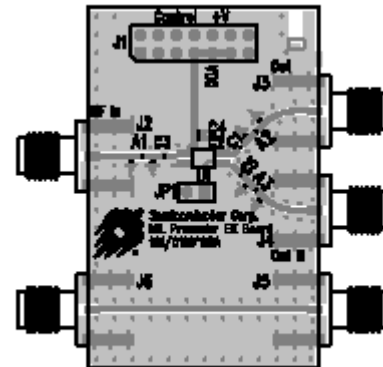
Figure 8. Evaluation Board Layout

transmission lines. The transmission lines were designed using a coplanar waveguide above ground plane model with trace width of 0.030", trace gaps of 0.007", dielectric thickness of 0.028", metal thickness of 0.0014" and ϵ_r of 4.4. Note that the predominate mode for these transmission lines is coplanar waveguide.

J2 provides DC power to the device. Starting from the lower left pin, the second pin to the right (J2-3) is connected to the device VDD pin (1). Two decoupling capacitors (10pF, 1000pF) are included on this trace. It is the responsibility of the customer to determine proper supply decoupling for their design application.

Applications Support

If you have a problem with your evaluation kit or if you have applications questions call (858) 455-0660 and ask for applications support. You may also contact us by fax or e-mail:

Fax: (858) 455-0770

E-Mail: help@peregrine-semi.com

Figure 9. Package Drawing

8 Lead Plastic MSOP

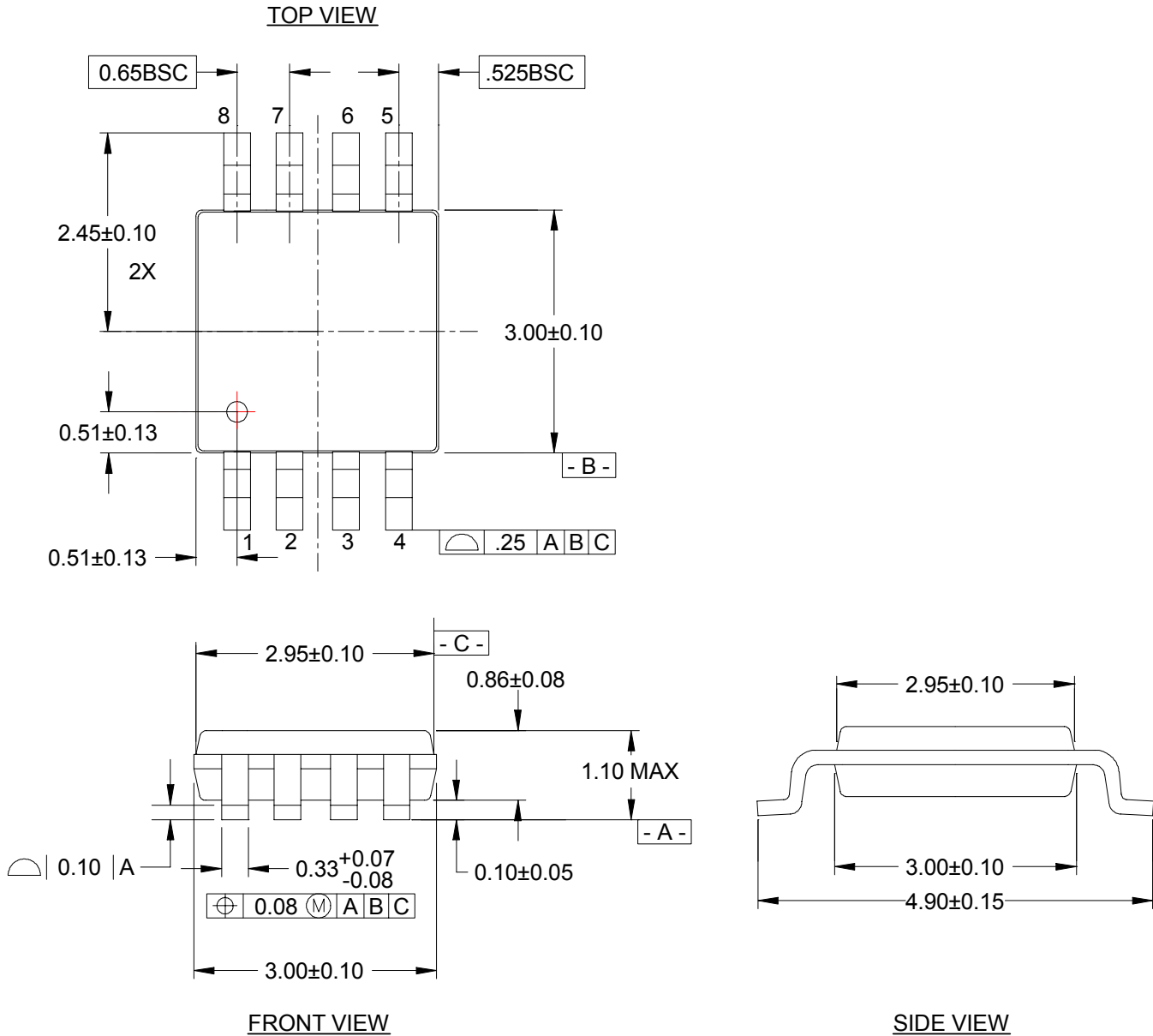

Table 4. Ordering Information

Order Code	Part Marking	Description	Package	Shipping Method
83512-01	PE83512	PE83512-08MSOP-50A	8-lead MSOP	50 units / Tube
83512-02	PE83512	PE83512-08MSOP-2000C	8-lead MSOP	2000 units / T&R
83512-00	PE83512-EK	PE83512-08MSOP-EK	Evaluation Kit	1 / Box

Sales Offices

United States

Peregrine Semiconductor Corp.

6175 Nancy Ridge Drive
San Diego, CA 92121
Tel 1-858-455-0660
Fax 1-858-455-0770

Japan

Peregrine Semiconductor K.K.

5A-5, 5F Imperial Tower
1-1-1 Uchisiwaicho,
Chiyoda-ku, Tokyo, Japan
100-011
Tel. 011-81-3-3502-5211
Fax. 011-81-3-3502-5213

Europe

Peregrine Semiconductor Europe

Aix-En-Provence Office
Parc Club du Golf, bat 9
13856 Aix-En-Provence Cedex 3
France
Tel 33-0-4-4239-3360
Fax 33-0-4-4239-7227

For a list of representatives in your area, please refer to our Web site at: <http://www.peregrine-semi.com>

Data Sheet Identification

Advance Information

The product is in a formative or design stage. The data sheet contains design target specifications for product development. Specifications and features may change in any manner without notice.

Preliminary Specification

The data sheet contains preliminary data. Additional data may be added at a later date. Peregrine reserves the right to change specifications at any time without notice in order to supply the best possible product.

Product Specification

The data sheet contains final data. In the event Peregrine decides to change the specifications, Peregrine will notify customers of the intended changes by issuing a PCN (Product Change Notice).

The information in this data sheet is believed to be reliable. However, Peregrine assumes no liability for the use of this information. Use shall be entirely at the user's own risk.

No patent rights or licenses to any circuits described in this data sheet are implied or granted to any third party.

Peregrine's products are not designed or intended for use in devices or systems intended for surgical implant, or in other applications intended to support or sustain life, or in any application in which the failure of the Peregrine product could create a situation in which personal injury or death might occur. Peregrine assumes no liability for damages, including consequential or incidental damages, arising out of the use of its products in such applications.

Peregrine products are protected under one or more of the following U.S. patents: 6,090,648; 6,057,555; 5,973,382; 5,973,363; 5,930,638; 5,920,233; 5,895,957; 5,883,396; 5,864,162; 5,863,823; 5,861,336; 5,663,570; 5,610,790; 5,600,169; 5,596,205; 5,572,040; 5,492,857; 5,416,043. Other patents are pending.

Peregrine, the Peregrine logotype, Peregrine Semiconductor Corp., and UTSi are registered trademarks of Peregrine Semiconductor Corporation. Copyright © 2002 Peregrine Semiconductor Corp. All rights reserved.