

# RQG1001UPAQF

## NPN Silicon Germanium Transistor High Frequency Low Noise Amplifier

REJ03G1551-0100

Rev.1.00

Jul 20, 2007

### Features

- Ideal for LNA applications. e.g. Tuner, Wireless LAN, Cordless phone and etc.
- High gain and low noise.
  - MSG = 25 dB typ., NF = 0.65 dB typ. at  $V_{CE} = 2\text{ V}$ ,  $I_C = 5\text{ mA}$ ,  $f = 0.9\text{ GHz}$
  - MSG = 22 dB typ., NF = 0.75 dB typ. at  $V_{CE} = 2\text{ V}$ ,  $I_C = 5\text{ mA}$ ,  $f = 1.8\text{ GHz}$
  - MSG = 21 dB typ., NF = 0.85 dB typ. at  $V_{CE} = 2\text{ V}$ ,  $I_C = 5\text{ mA}$ ,  $f = 2.4\text{ GHz}$
  - MSG = 15 dB typ., NF = 1.3 dB typ. at  $V_{CE} = 2\text{ V}$ ,  $I_C = 10\text{ mA}$ ,  $f = 5.8\text{ GHz}$
- High transition frequency
  - $f_T = 35\text{ GHz}$  typ.
- CMPAK-4 (2.0 x 1.25 x 1.1(max) mm)

### Outline

RENESAS Package code: PTSP0004ZA-A  
(Package name: CMPAK-4)

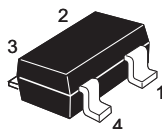

1. Emitter
2. Collector
3. Emitter
4. Base

Note: Marking is "UP-".

### Absolute Maximum Ratings

( $T_a = 25^\circ\text{C}$ )

Item	Symbol	Ratings	Unit
Collector to base voltage	$V_{CBO}$	8	V
Collector to emitter voltage	$V_{CEO}$	3.5	V
Emitter to base voltage	$V_{EBO}$	1.2	V
Collector current	$I_C$	35	mA
Collector power dissipation	$P_C$	100	mW
	$P_C$	250 <sup>note1</sup>	mW
Junction temperature	$T_j$	150	$^\circ\text{C}$
Storage temperature	$T_{stg}$	-55 to +150	$^\circ\text{C}$

Notes: 1. Value on PCB (FR-4 : 40 x 40 x 1.6mm double side)

## Electrical Characteristics

(Ta = 25°C)

Item	Symbol	Min.	Typ	Max.	Unit	Test Conditions	
DC current transfer ratio	$h_{FE}$	100	200	300	—	$V_{CE} = 2\text{ V}$ , $I_C = 5\text{ mA}$	
Reverse Transfer Capacitance	$C_{re}$	—	0.08	—	pF	$V_{CB} = 2\text{ V}$ , $I_E = 0$ , $f = 1\text{ MHz}$	
Transition Frequency	$f_T$	—	35	—	GHz	$V_{CE} = 2\text{ V}$ , $I_C = f_T\text{ peak}$ , $f = 1\text{ GHz}$	
Forward Transfer Coefficient	0.9 GHz	S <sub>21</sub>   <sup>2</sup>	—	22	—	dB	$V_{CE} = 2\text{ V}$ , $I_C = 5\text{ mA}$
	1.8 GHz		—	19	—		
	2.4 GHz		—	17	—		$V_{CE} = 2\text{ V}$ , $I_C = 10\text{ mA}$
	5.8 GHz		—	11	—		
Maximum Stable Gain Note1	0.9 GHz	MSG	—	25	—	dB	$V_{CE} = 2\text{ V}$ , $I_C = 5\text{ mA}$
	1.8 GHz		—	22	—		
	2.4 GHz		—	21	—		$V_{CE} = 2\text{ V}$ , $I_C = 10\text{ mA}$
	5.8 GHz		—	15	—		
Maximum Available Gain Note2	5.8 GHz	MAG	—	13	—	dB	$V_{CE} = 2\text{ V}$ , $I_C = 10\text{ mA}$
Power Gain	0.9 GHz	PG	—	22	—	dB	$V_{CE} = 2\text{ V}$ , $I_C = 5\text{ mA}$
	1.8 GHz		—	19.5	—		
	2.4 GHz		—	18	—		$V_{CE} = 2\text{ V}$ , $I_C = 10\text{ mA}$
	5.8 GHz		—	11.5	—		
Noise figure	0.9 GHz	NF	—	0.7	—	dB	$V_{CE} = 2\text{ V}$ , $I_C = 5\text{ mA}$
	1.8 GHz		—	0.75	—		
	2.4 GHz		—	0.85	—		$V_{CE} = 2\text{ V}$ , $I_C = 10\text{ mA}$
	5.8 GHz		—	1.3	—		

Notes: 1.  $MSG = |S_{21}| / |S_{12}|$ 2.  $MAG = |S_{21}| / |S_{12}|(K \cdot (K^2 - 1))^{1/2}$

Main Characteristics

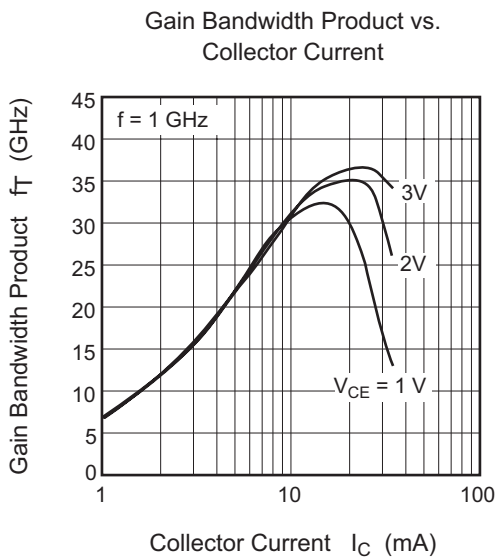
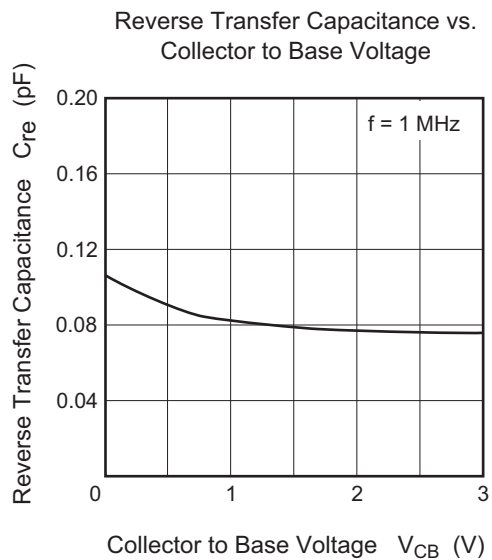
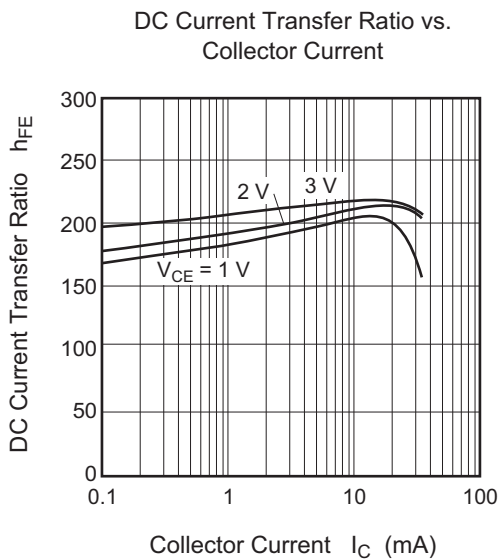
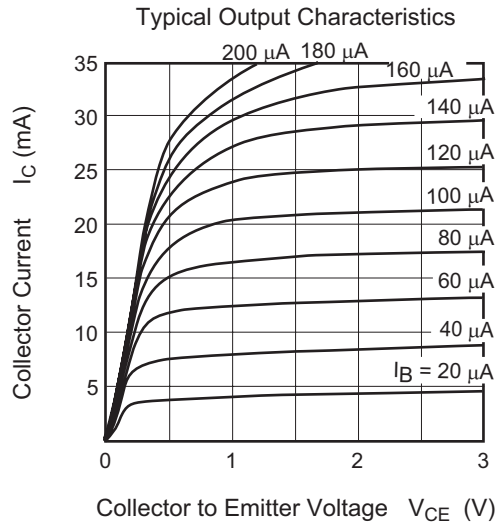
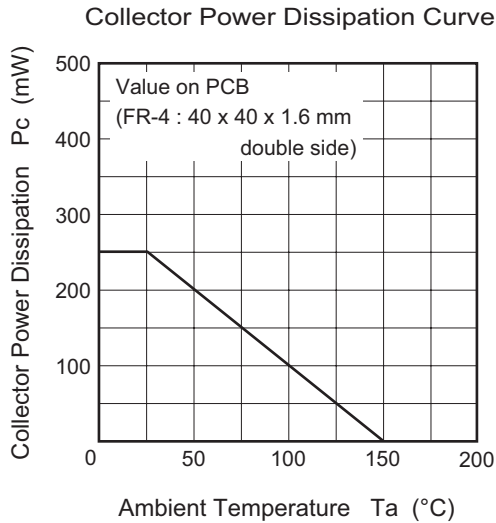

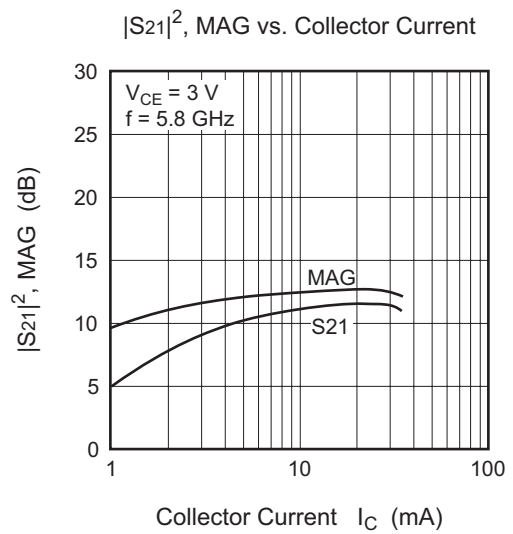
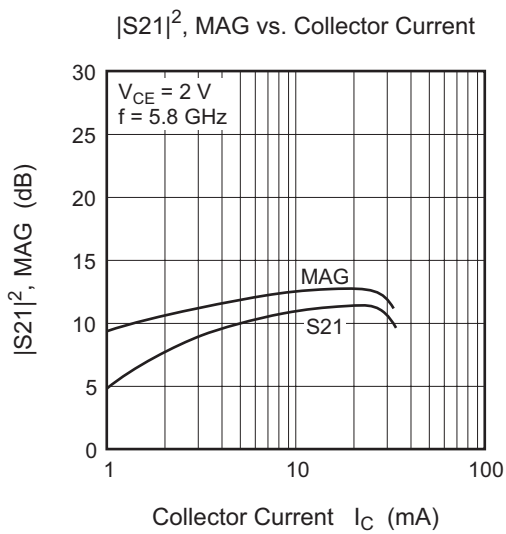
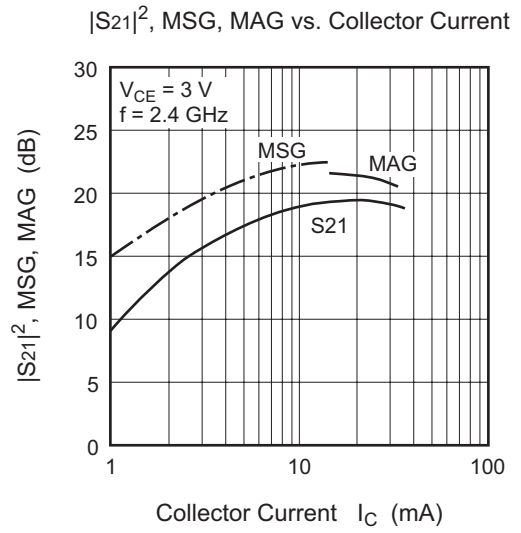
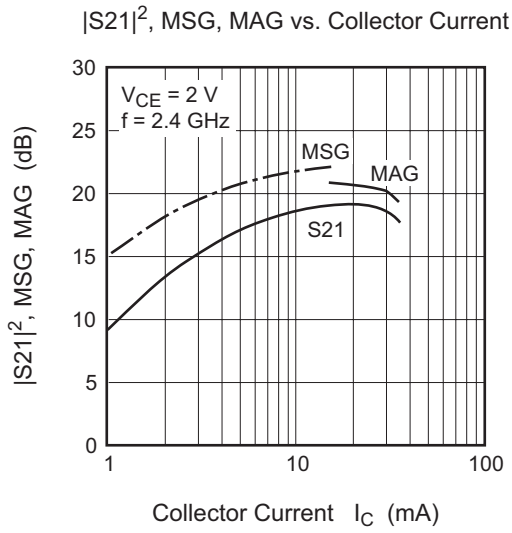
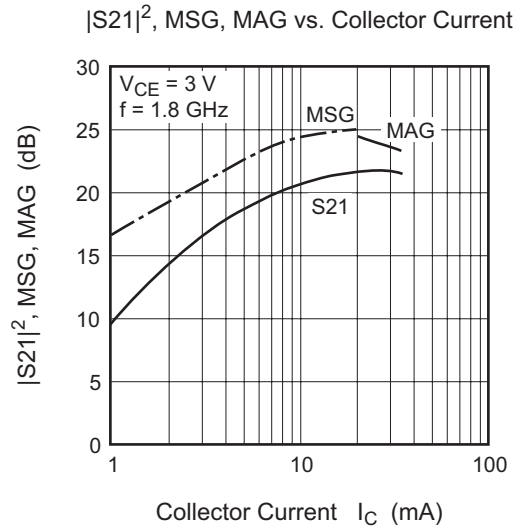
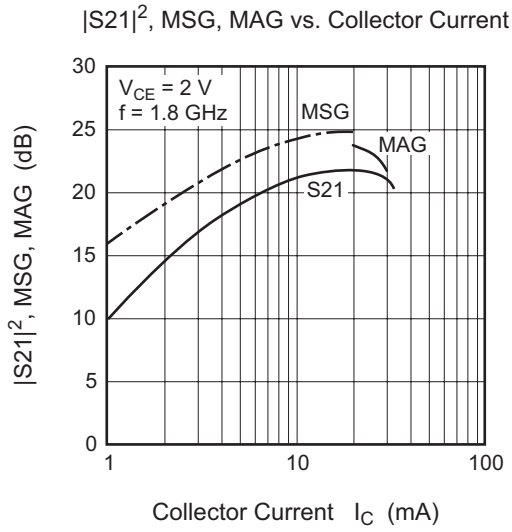

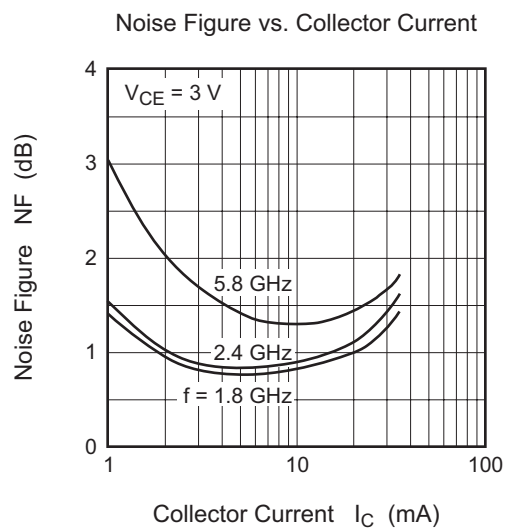
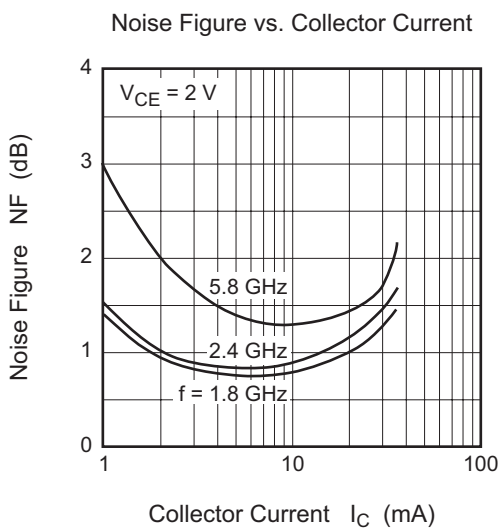
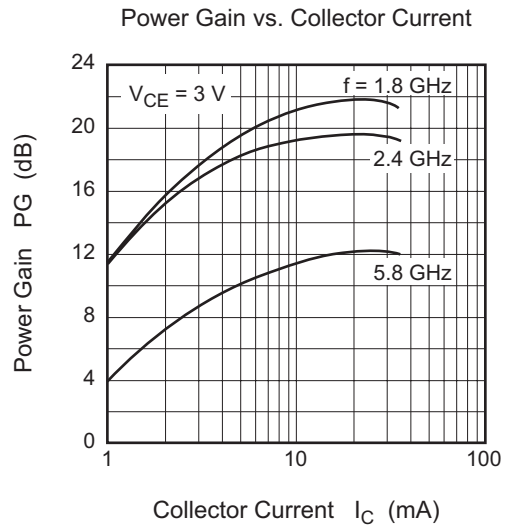
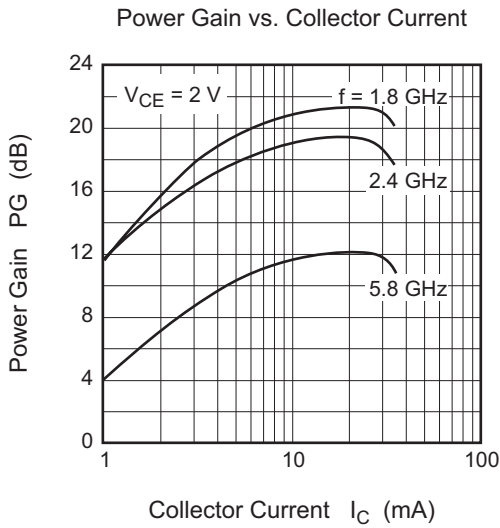
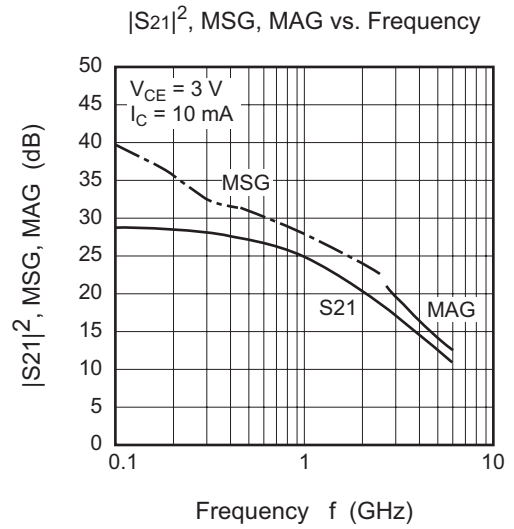
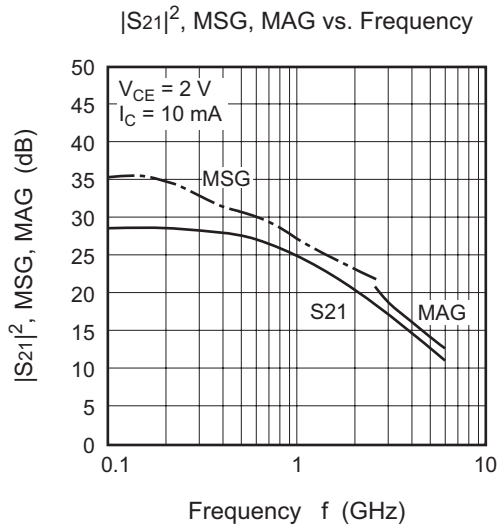

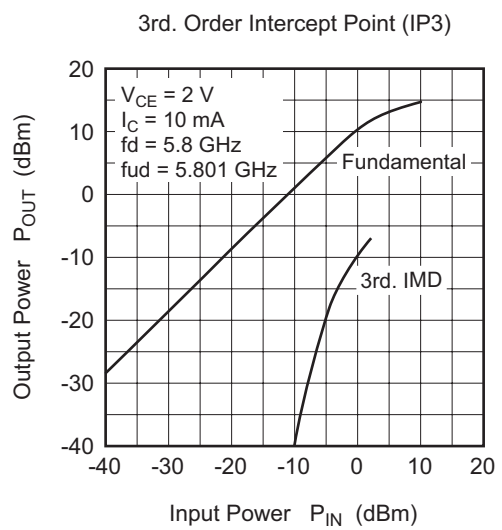
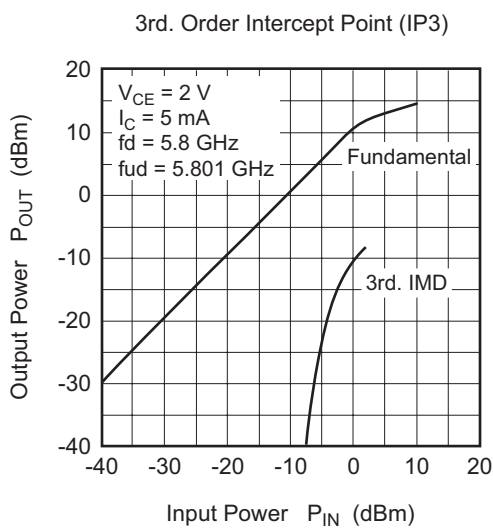
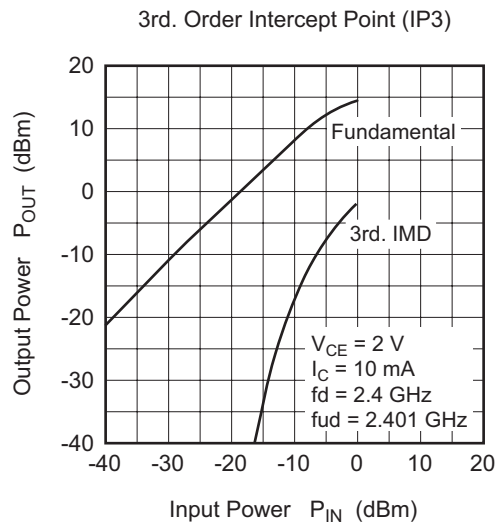
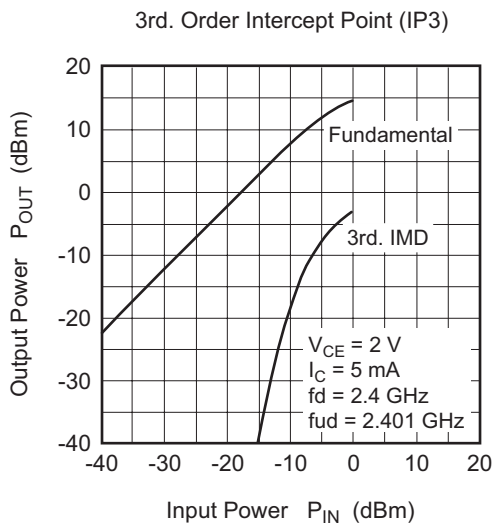
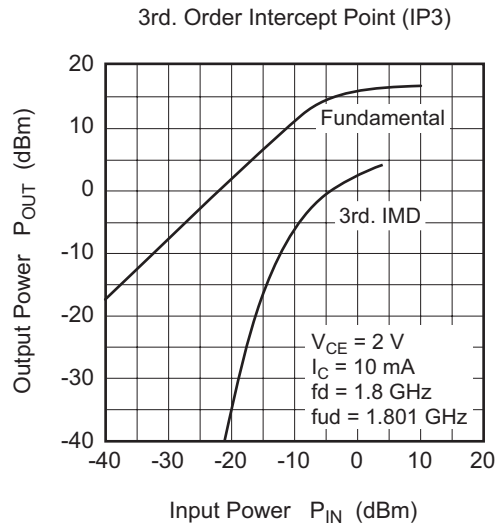
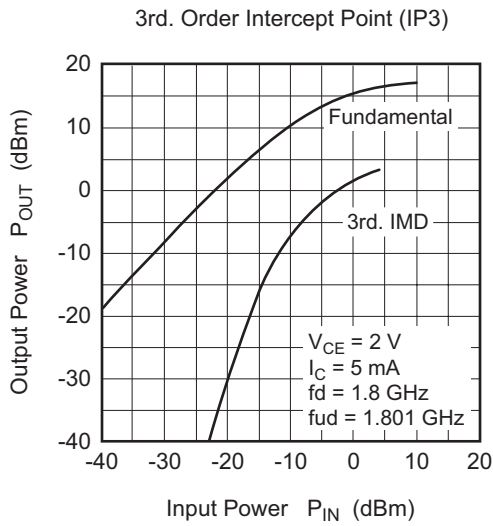

3rd. Order Intercept Point (IP3)

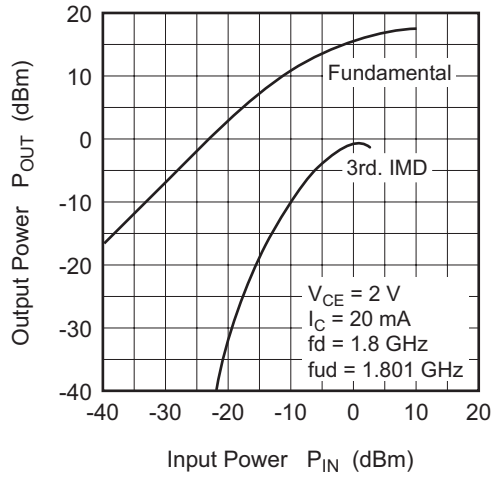

3rd. Order Intercept Point (IP3)

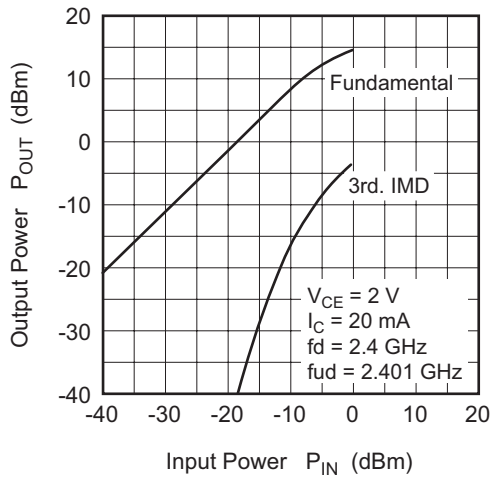

3rd. Order Intercept Point (IP3)

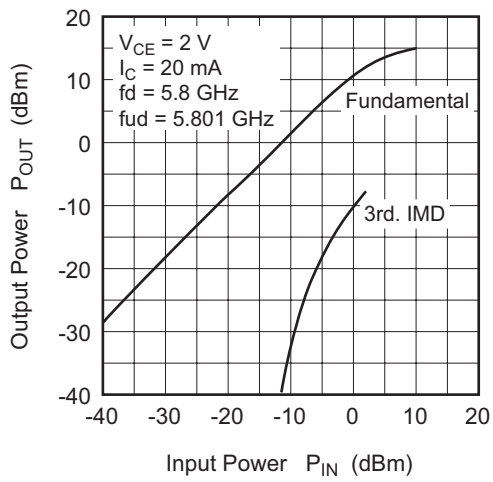

S11 Parameter vs. Frequency

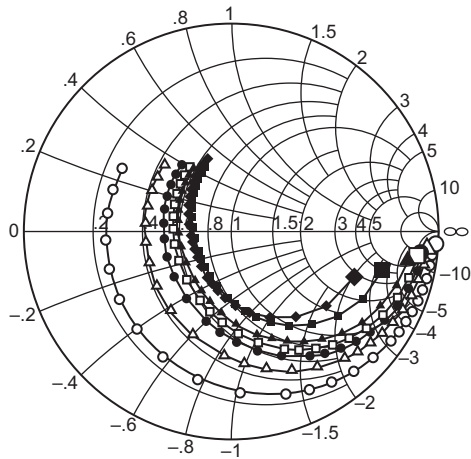

Condition:  $V_{CE} = 2\text{ V}$ ,  $Z_o = 50\ \Omega$   
 100 to 1000 MHz (100 MHz step)  
 1000 to 2000 MHz (200 MHz step)  
 2000 to 6000 MHz (400 MHz step)

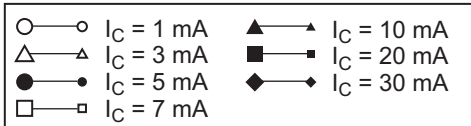

S21 Parameter vs. Frequency

Scale: 15 / div.

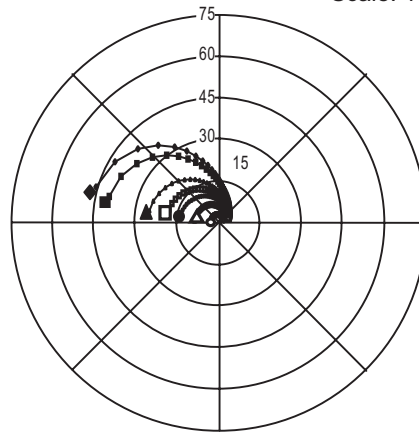

Condition:  $V_{CE} = 2\text{ V}$ ,  $Z_o = 50\ \Omega$   
 100 to 6000 MHz (100 MHz step)



S12 Parameter vs. Frequency

Scale: 0.1 / div.

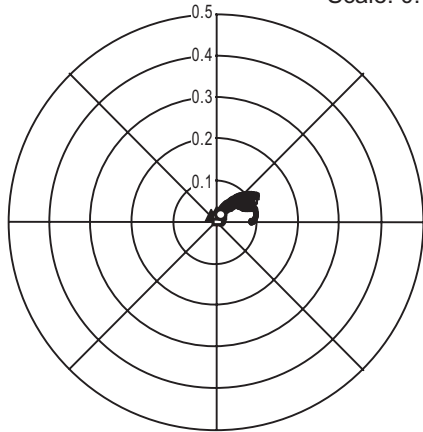

Condition:  $V_{CE} = 2\text{ V}$ ,  $Z_o = 50\ \Omega$   
 100 to 6000 MHz (100 MHz step)

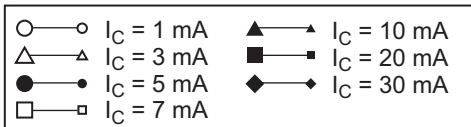

S22 Parameter vs. Frequency

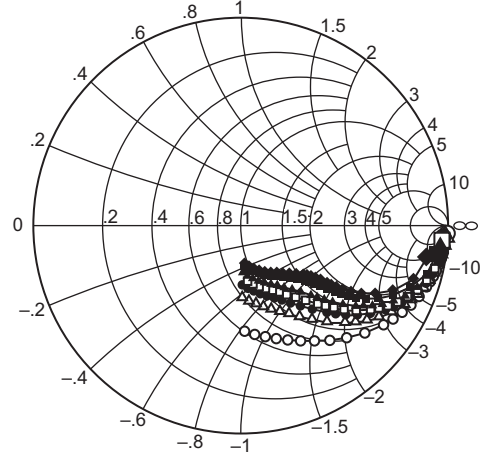

Condition:  $V_{CE} = 2\text{ V}$ ,  $Z_o = 50\ \Omega$   
 100 to 1000 MHz (100 MHz step)  
 1000 to 2000 MHz (200 MHz step)  
 2000 to 6000 MHz (400 MHz step)





S11 Parameter vs. Frequency

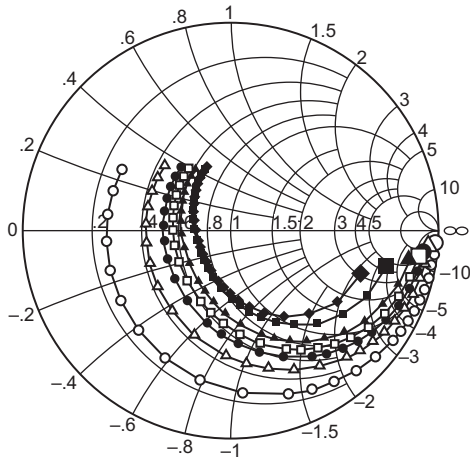

Condition:  $V_{CE} = 3\text{ V}$ ,  $Z_o = 50\ \Omega$   
 100 to 1000 MHz (100 MHz step)  
 1000 to 2000 MHz (200 MHz step)  
 2000 to 6000 MHz (400 MHz step)

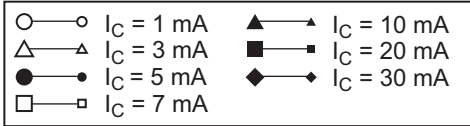

S21 Parameter vs. Frequency

Scale: 15 / div.

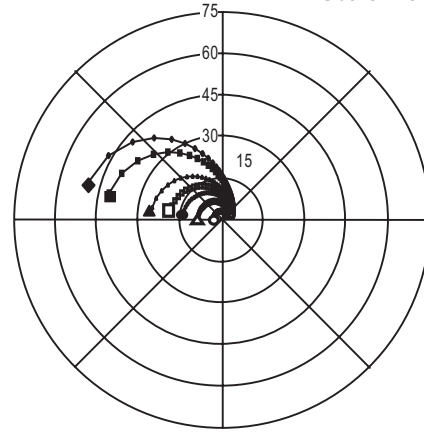

Condition:  $V_{CE} = 3\text{ V}$ ,  $Z_o = 50\ \Omega$   
 100 to 6000 MHz (100 MHz step)



S12 Parameter vs. Frequency

Scale: 0.1 / div.

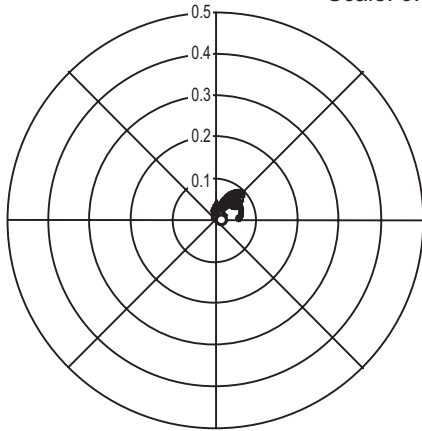

Condition:  $V_{CE} = 3\text{ V}$ ,  $Z_o = 50\ \Omega$   
 100 to 6000 MHz (100 MHz step)



S22 Parameter vs. Frequency

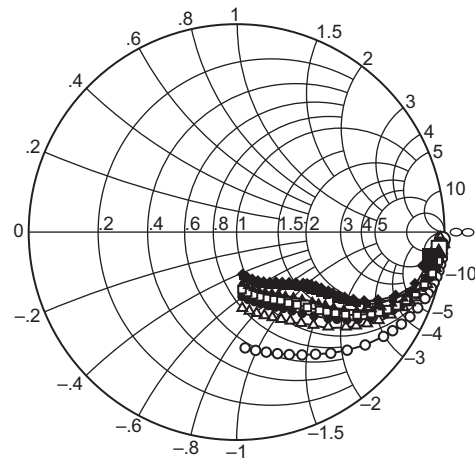

Condition:  $V_{CE} = 3\text{ V}$ ,  $Z_o = 50\ \Omega$   
 100 to 1000 MHz (100 MHz step)  
 1000 to 2000 MHz (200 MHz step)  
 2000 to 6000 MHz (400 MHz step)



## S Parameter

 $(V_{CE} = 2\text{ V}, I_C = 5\text{ mA}, Z_O = 50\ \Omega)$ 

f (MHz)	S11		S21		S12		S22	
	MAG	ANG(deg.)	MAG	ANG(deg.)	MAG	ANG(deg.)	MAG	ANG(deg.)
100	0.923	-6.2	14.39	173.5	0.0092	34.3	0.979	-3.2
200	0.915	-12.3	14.26	167.6	0.0094	83.2	0.987	-7.1
300	0.896	-18.2	14.03	162.0	0.0144	73.0	0.974	-10.7
400	0.878	-24.5	13.78	156.6	0.0167	76.6	0.956	-14.0
500	0.855	-30.4	13.53	151.5	0.0207	68.8	0.935	-17.2
600	0.828	-36.3	13.22	146.7	0.0254	70.2	0.912	-20.1
700	0.803	-41.8	12.78	142.1	0.0285	65.0	0.887	-23.0
800	0.774	-47.2	12.41	137.6	0.0310	61.7	0.860	-25.6
900	0.743	-52.9	12.15	133.5	0.0340	60.5	0.833	-27.9
1000	0.712	-58.1	11.75	129.1	0.0364	58.8	0.806	-30.1
1100	0.682	-63.2	11.35	125.1	0.0403	56.0	0.781	-32.1
1200	0.650	-68.4	11.01	121.1	0.0400	53.8	0.754	-34.0
1300	0.621	-73.1	10.60	117.5	0.0421	51.7	0.729	-35.8
1400	0.594	-78.0	10.21	114.1	0.0452	50.4	0.707	-37.4
1500	0.566	-82.8	9.87	110.7	0.0464	48.2	0.684	-38.9
1600	0.540	-87.5	9.53	107.4	0.0478	47.9	0.663	-40.2
1700	0.517	-92.1	9.18	104.4	0.0498	46.6	0.644	-41.6
1800	0.495	-96.7	8.85	101.5	0.0508	45.0	0.624	-42.8
1900	0.475	-101.1	8.54	98.7	0.0516	44.5	0.606	-44.1
2000	0.455	-105.8	8.25	96.0	0.0528	43.6	0.589	-45.1
2200	0.423	-114.6	7.69	90.9	0.0556	41.7	0.558	-47.3
2400	0.395	-123.6	7.21	86.0	0.0569	41.1	0.530	-49.3
2600	0.373	-132.2	6.76	81.5	0.0599	38.9	0.504	-51.4
2800	0.357	-141.1	6.36	77.2	0.0616	39.1	0.482	-53.3
3000	0.345	-149.5	5.99	73.1	0.0633	38.3	0.461	-55.1
3200	0.338	-157.6	5.66	69.1	0.0662	37.4	0.443	-57.2
3400	0.332	-165.6	5.36	65.3	0.0680	36.9	0.425	-59.2
3600	0.328	-172.7	5.08	61.7	0.0695	35.7	0.409	-61.0
3800	0.327	-179.6	4.83	58.3	0.0719	35.8	0.396	-62.9
4000	0.330	174.2	4.61	54.9	0.0743	35.2	0.384	-65.0
4200	0.335	168.2	4.40	51.5	0.0772	34.1	0.372	-67.3
4400	0.340	162.6	4.22	48.2	0.0795	33.9	0.361	-69.5
4600	0.346	157.3	4.04	45.0	0.0817	32.9	0.351	-71.7
4800	0.352	152.4	3.88	41.9	0.0849	31.9	0.341	-73.9
5000	0.359	147.7	3.73	38.7	0.0868	31.3	0.331	-76.2
5200	0.366	143.2	3.60	35.6	0.0894	30.5	0.321	-78.6
5400	0.374	139.0	3.46	32.6	0.0931	29.4	0.312	-81.1
5600	0.381	135.1	3.35	29.6	0.0949	28.6	0.304	-83.5
5800	0.388	131.3	3.23	26.6	0.0978	27.0	0.294	-86.0
6000	0.396	127.5	3.13	23.6	0.1013	26.2	0.285	-88.5

## S Parameter

(V<sub>CE</sub> = 2 V, I<sub>C</sub> = 10 mA, Z<sub>O</sub> = 50 Ω)

f (MHz)	S11		S21		S12		S22	
	MAG	ANG(deg.)	MAG	ANG(deg.)	MAG	ANG(deg.)	MAG	ANG(deg.)
100	0.864	-9.4	25.72	170.8	0.0082	99.3	0.968	-5.9
200	0.840	-18.0	25.13	162.4	0.0078	94.0	0.967	-10.4
300	0.804	-26.3	24.22	154.7	0.0121	80.8	0.937	-15.0
400	0.769	-34.7	23.24	147.6	0.0174	71.6	0.902	-19.2
500	0.725	-42.4	22.19	141.1	0.0196	68.5	0.863	-23.1
600	0.679	-49.7	21.06	135.0	0.0214	64.0	0.822	-26.1
700	0.636	-56.4	19.83	129.6	0.0247	62.5	0.782	-29.0
800	0.592	-62.7	18.72	124.4	0.0269	59.2	0.744	-31.2
900	0.551	-69.0	17.70	119.9	0.0270	58.5	0.707	-33.0
1000	0.514	-74.6	16.67	115.6	0.0296	55.8	0.678	-34.9
1100	0.478	-80.1	15.71	111.6	0.0319	54.7	0.649	-36.3
1200	0.446	-85.5	14.85	107.9	0.0334	54.7	0.622	-37.5
1300	0.417	-90.3	14.02	104.6	0.0348	54.6	0.597	-38.6
1400	0.392	-95.3	13.27	101.5	0.0368	54.4	0.577	-39.6
1500	0.367	-100.3	12.60	98.6	0.0378	53.4	0.556	-40.6
1600	0.347	-105.1	11.97	95.8	0.0390	53.4	0.538	-41.4
1700	0.329	-110.0	11.39	93.2	0.0414	52.8	0.521	-42.3
1800	0.313	-114.8	10.87	90.7	0.0428	52.3	0.505	-43.0
1900	0.299	-119.8	10.38	88.4	0.0440	52.2	0.491	-43.9
2000	0.286	-124.6	9.93	86.1	0.0444	51.2	0.477	-44.6
2200	0.267	-134.2	9.14	81.8	0.0486	51.2	0.454	-46.1
2400	0.254	-143.7	8.45	77.8	0.0512	50.7	0.432	-47.7
2600	0.244	-153.0	7.85	74.0	0.0541	49.6	0.412	-49.3
2800	0.240	-162.2	7.33	70.4	0.0579	48.6	0.395	-51.0
3000	0.239	-170.3	6.87	66.9	0.0611	48.2	0.380	-52.8
3200	0.241	-178.5	6.46	63.5	0.0630	47.2	0.365	-54.8
3400	0.244	174.3	6.10	60.2	0.0659	46.9	0.351	-56.6
3600	0.249	167.5	5.76	57.1	0.0687	46.0	0.337	-58.3
3800	0.254	162.1	5.47	54.1	0.0722	44.9	0.327	-60.4
4000	0.262	156.8	5.21	51.1	0.0761	44.2	0.318	-62.5
4200	0.270	151.9	4.97	48.1	0.0787	42.6	0.308	-64.8
4400	0.279	147.3	4.75	45.2	0.0831	41.5	0.297	-67.1
4600	0.288	142.9	4.55	42.3	0.0861	40.4	0.289	-69.6
4800	0.296	139.0	4.36	39.4	0.0898	38.9	0.280	-71.9
5000	0.305	135.1	4.19	36.6	0.0925	37.6	0.270	-74.4
5200	0.314	131.7	4.04	33.7	0.0960	36.3	0.261	-76.9
5400	0.323	128.4	3.89	30.9	0.0994	34.8	0.252	-79.5
5600	0.332	125.2	3.76	28.1	0.1020	33.4	0.244	-82.1
5800	0.341	122.0	3.63	25.3	0.1063	31.7	0.235	-84.7
6000	0.349	119.1	3.51	22.5	0.1093	30.2	0.226	-87.3

## S Parameter

 $(V_{CE} = 3 \text{ V}, I_C = 5 \text{ mA}, Z_O = 50 \Omega)$ 

f (MHz)	S11		S21		S12		S22	
	MAG	ANG(deg.)	MAG	ANG(deg.)	MAG	ANG(deg.)	MAG	ANG(deg.)
100	0.930	-6.3	14.29	173.6	0.0045	46.5	0.986	-3.6
200	0.918	-12.3	14.19	167.7	0.0087	92.6	0.985	-6.8
300	0.902	-18.0	13.97	162.2	0.0146	67.7	0.976	-10.2
400	0.883	-24.1	13.74	156.9	0.0156	76.6	0.955	-13.3
500	0.859	-30.0	13.50	151.9	0.0205	68.1	0.938	-16.5
600	0.834	-35.8	13.20	147.1	0.0252	68.1	0.916	-19.2
700	0.809	-41.1	12.77	142.5	0.0265	66.6	0.892	-22.0
800	0.781	-46.5	12.42	138.0	0.0302	62.5	0.866	-24.5
900	0.750	-52.3	12.18	134.0	0.0318	61.0	0.840	-26.7
1000	0.719	-57.3	11.78	129.6	0.0353	59.0	0.815	-28.8
1100	0.688	-62.4	11.39	125.6	0.0373	55.2	0.790	-30.8
1200	0.656	-67.5	11.06	121.6	0.0386	54.0	0.766	-32.6
1300	0.627	-72.2	10.65	117.9	0.0411	53.4	0.742	-34.2
1400	0.600	-76.9	10.26	114.6	0.0436	50.7	0.720	-35.8
1500	0.571	-81.7	9.92	111.2	0.0440	48.5	0.698	-37.3
1600	0.544	-86.5	9.58	107.9	0.0456	47.9	0.678	-38.5
1700	0.522	-90.8	9.24	104.9	0.0475	46.6	0.658	-39.8
1800	0.499	-95.4	8.91	102.0	0.0482	46.0	0.640	-41.0
1900	0.479	-99.9	8.60	99.2	0.0495	45.5	0.622	-42.2
2000	0.458	-104.5	8.31	96.4	0.0505	44.1	0.606	-43.3
2200	0.425	-113.2	7.75	91.3	0.0527	42.6	0.576	-45.4
2400	0.397	-122.1	7.26	86.5	0.0549	41.6	0.548	-47.3
2600	0.374	-130.9	6.81	82.0	0.0571	41.2	0.524	-49.2
2800	0.357	-139.6	6.42	77.7	0.0594	41.0	0.503	-51.1
3000	0.343	-147.9	6.05	73.5	0.0609	39.6	0.482	-52.9
3200	0.335	-156.0	5.71	69.6	0.0629	38.2	0.463	-55.0
3400	0.329	-164.1	5.41	65.8	0.0648	37.3	0.447	-56.8
3600	0.324	-171.3	5.13	62.2	0.0662	36.9	0.431	-58.6
3800	0.323	-178.1	4.88	58.8	0.0686	37.1	0.418	-60.4
4000	0.326	175.5	4.66	55.4	0.0713	36.3	0.407	-62.6
4200	0.330	169.4	4.45	52.0	0.0743	35.8	0.395	-64.6
4400	0.334	163.7	4.26	48.7	0.0761	34.9	0.385	-66.8
4600	0.340	158.4	4.09	45.5	0.0788	34.5	0.374	-68.8
4800	0.346	153.2	3.92	42.4	0.0814	33.3	0.364	-71.3
5000	0.353	148.5	3.77	39.3	0.0838	33.1	0.356	-73.3
5200	0.360	144.0	3.64	36.1	0.0865	31.7	0.345	-75.7
5400	0.367	139.9	3.50	33.1	0.0893	31.0	0.337	-78.1
5600	0.375	135.8	3.38	30.1	0.0917	29.9	0.329	-80.4
5800	0.382	131.9	3.27	27.1	0.0937	28.6	0.320	-82.8
6000	0.390	128.2	3.16	24.1	0.0979	27.7	0.311	-85.2

## S Parameter

(V<sub>CE</sub> = 3 V, I<sub>C</sub> = 10 mA, Z<sub>O</sub> = 50 Ω)

f (MHz)	S11		S21		S12		S22	
	MAG	ANG(deg.)	MAG	ANG(deg.)	MAG	ANG(deg.)	MAG	ANG(deg.)
100	0.869	-9.2	25.72	170.8	0.0029	161.5	0.979	-6.0
200	0.847	-17.6	25.14	162.6	0.0068	89.6	0.971	-9.8
300	0.814	-25.7	24.24	155.0	0.0133	71.1	0.942	-14.3
400	0.778	-33.9	23.28	148.1	0.0152	73.5	0.906	-18.2
500	0.732	-41.5	22.26	141.5	0.0180	67.2	0.870	-21.9
600	0.686	-48.8	21.13	135.5	0.0209	64.6	0.830	-24.9
700	0.645	-55.3	19.92	130.1	0.0231	63.0	0.791	-27.6
800	0.601	-61.5	18.82	125.0	0.0250	59.1	0.755	-29.8
900	0.558	-67.8	17.81	120.4	0.0271	57.3	0.723	-31.6
1000	0.520	-73.2	16.80	116.1	0.0295	57.6	0.691	-33.2
1100	0.486	-78.5	15.83	112.2	0.0308	56.0	0.663	-34.6
1200	0.452	-83.8	14.98	108.5	0.0319	54.4	0.637	-35.8
1300	0.422	-88.7	14.14	105.1	0.0339	54.4	0.614	-36.9
1400	0.397	-93.6	13.40	102.0	0.0350	55.5	0.592	-37.9
1500	0.373	-98.4	12.72	99.1	0.0366	54.1	0.574	-38.9
1600	0.351	-103.3	12.09	96.3	0.0382	53.1	0.555	-39.5
1700	0.332	-107.9	11.51	93.7	0.0397	52.1	0.540	-40.4
1800	0.315	-112.8	10.98	91.2	0.0401	52.0	0.524	-41.1
1900	0.300	-117.5	10.49	88.9	0.0419	51.5	0.510	-41.9
2000	0.287	-122.3	10.04	86.6	0.0435	52.4	0.497	-42.7
2200	0.266	-131.7	9.24	82.3	0.0464	51.1	0.474	-44.2
2400	0.251	-141.4	8.55	78.3	0.0490	51.3	0.453	-45.8
2600	0.241	-150.6	7.95	74.5	0.0520	50.4	0.433	-47.3
2800	0.235	-159.8	7.42	70.9	0.0554	49.7	0.418	-48.9
3000	0.233	-168.4	6.96	67.4	0.0580	49.0	0.401	-50.5
3200	0.235	-176.3	6.54	64.0	0.0613	47.8	0.388	-52.6
3400	0.238	176.0	6.18	60.7	0.0641	47.2	0.374	-54.3
3600	0.241	169.1	5.84	57.6	0.0668	46.7	0.361	-55.9
3800	0.246	163.4	5.54	54.6	0.0705	46.2	0.350	-57.8
4000	0.255	158.2	5.28	51.6	0.0737	45.0	0.341	-60.0
4200	0.261	153.0	5.03	48.6	0.0770	43.8	0.331	-62.4
4400	0.270	148.1	4.81	45.7	0.0806	42.6	0.321	-64.5
4600	0.279	144.0	4.61	42.8	0.0838	41.7	0.313	-66.9
4800	0.288	139.9	4.42	40.0	0.0860	40.5	0.303	-69.1
5000	0.297	136.1	4.25	37.1	0.0901	39.0	0.294	-71.6
5200	0.306	132.5	4.10	34.3	0.0929	37.6	0.286	-74.0
5400	0.314	129.0	3.95	31.5	0.0967	36.4	0.276	-76.4
5600	0.323	125.8	3.81	28.7	0.0999	34.5	0.269	-78.8
5800	0.331	122.7	3.68	25.9	0.1027	33.1	0.260	-81.4
6000	0.340	119.6	3.56	23.1	0.1058	31.5	0.252	-83.8

## RQG1001 5.8 GHz Evaluation Board

### Evaluation Board Pattern Layout

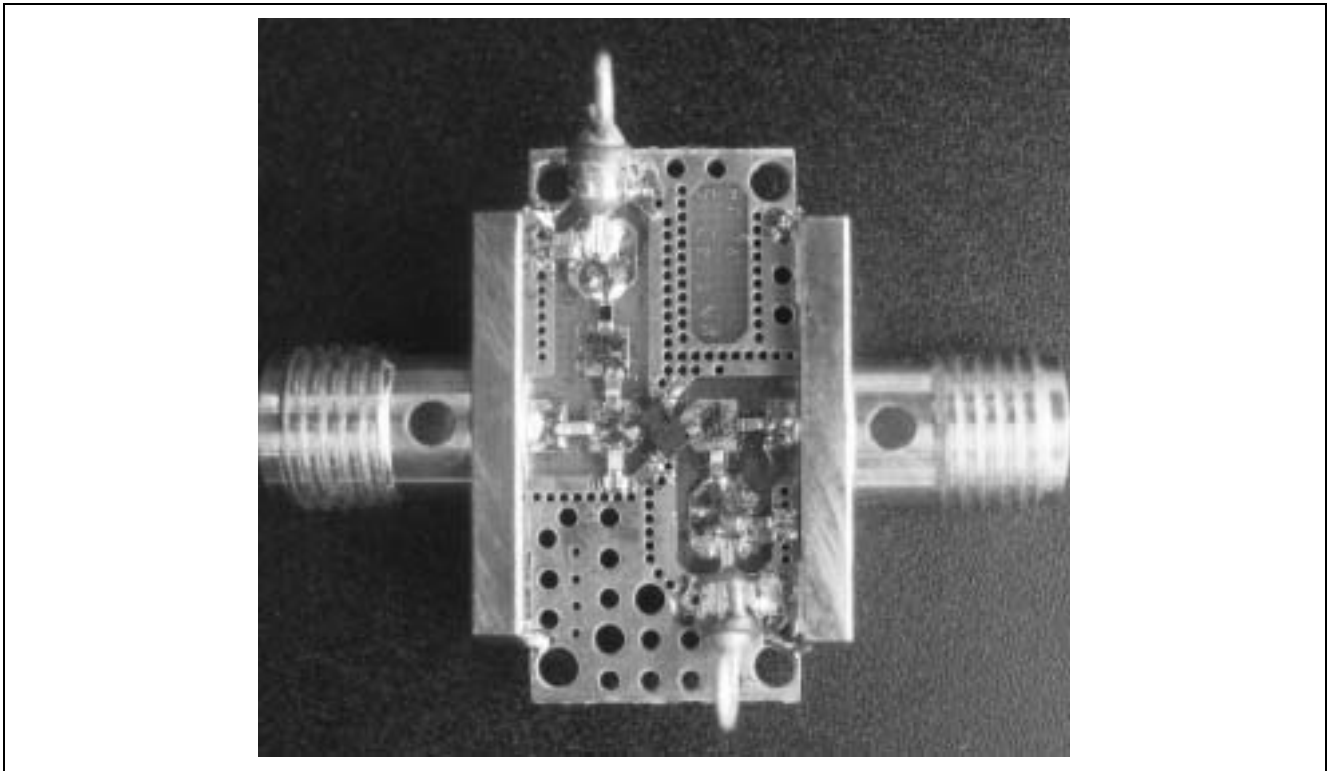

### Circuit

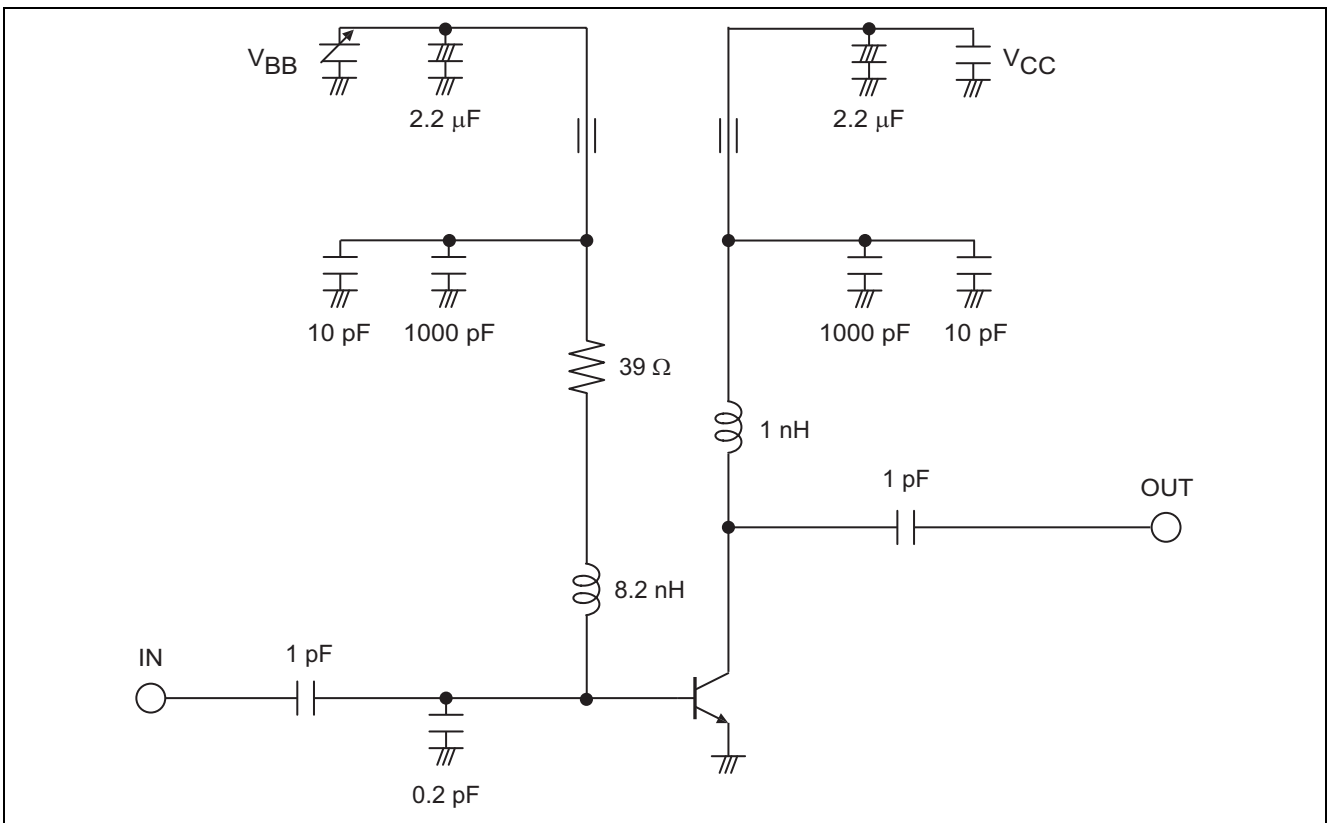

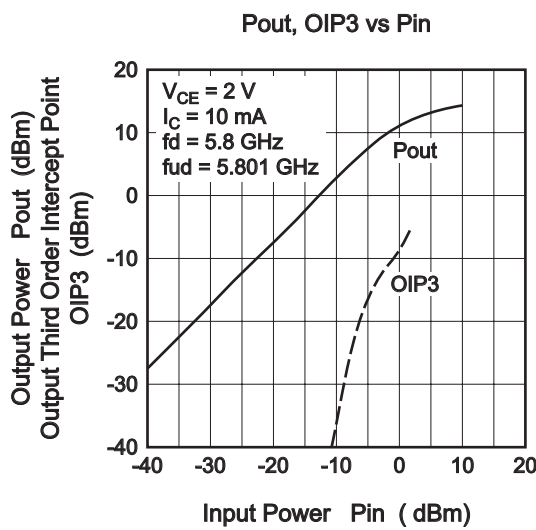
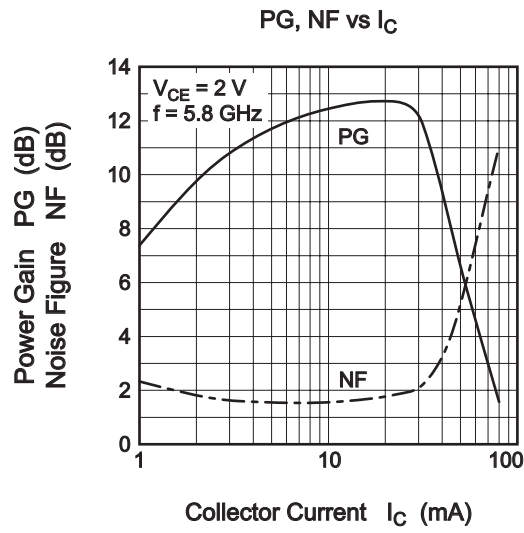
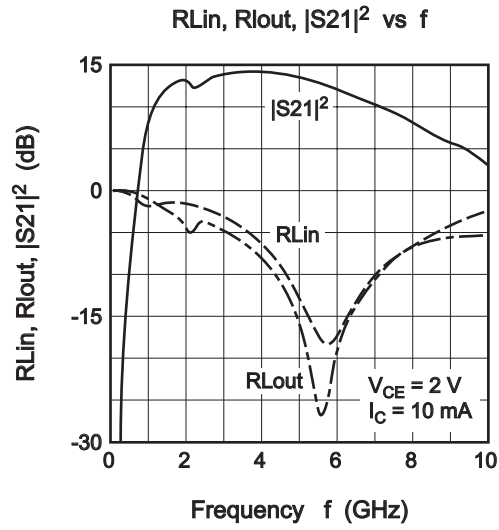

### Package Dimensions

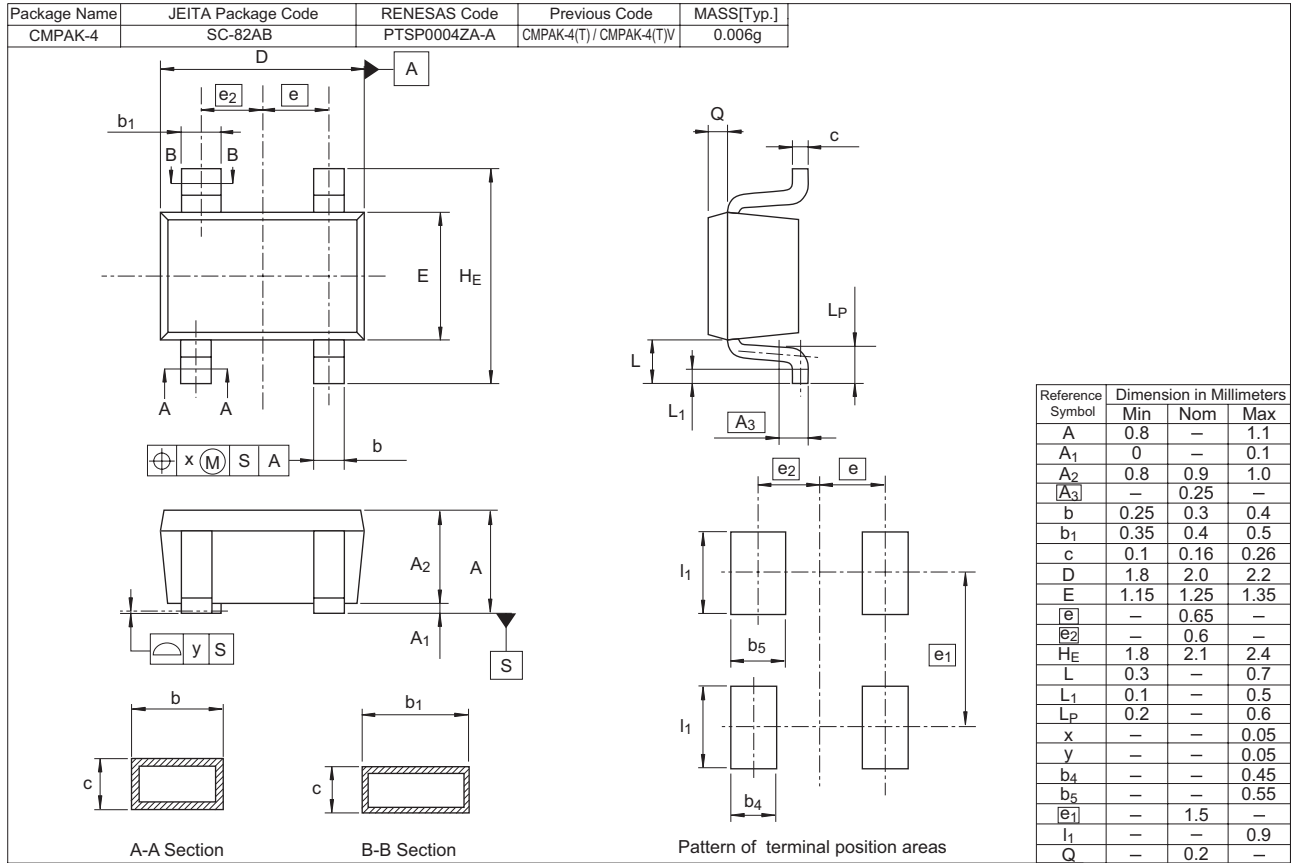

### Ordering Information

Part No.	Quantity	Shipping Container
RQG1001UP-TL-E	3000 pcs	φ178 mm reel, 8 mm emboss taping

Note: For some grades, production may be terminated. Please contact the Renesas sales office to check the state of production before ordering the product.



Notes:

1. This document is provided for reference purposes only so that Renesas customers may select the appropriate Renesas products for their use. Renesas neither makes warranties or representations with respect to the accuracy or completeness of the information contained in this document nor grants any license to any intellectual property rights or any other rights of Renesas or any third party with respect to the information in this document.
2. Renesas shall have no liability for damages or infringement of any intellectual property or other rights arising out of the use of any information in this document, including, but not limited to, product data, diagrams, charts, programs, algorithms, and application circuit examples.
3. You should not use the products or the technology described in this document for the purpose of military applications such as the development of weapons of mass destruction or for the purpose of any other military use. When exporting the products or technology described herein, you should follow the applicable export control laws and regulations, and procedures required by such laws and regulations.
4. All information included in this document such as product data, diagrams, charts, programs, algorithms, and application circuit examples, is current as of the date this document is issued. Such information, however, is subject to change without any prior notice. Before purchasing or using any Renesas products listed in this document, please confirm the latest product information with a Renesas sales office. Also, please pay regular and careful attention to additional and different information to be disclosed by Renesas such as that disclosed through our website. (<http://www.renesas.com>)
5. Renesas has used reasonable care in compiling the information included in this document, but Renesas assumes no liability whatsoever for any damages incurred as a result of errors or omissions in the information included in this document.
6. When using or otherwise relying on the information in this document, you should evaluate the information in light of the total system before deciding about the applicability of such information to the intended application. Renesas makes no representations, warranties or guarantees regarding the suitability of its products for any particular application and specifically disclaims any liability arising out of the application and use of the information in this document or Renesas products.
7. With the exception of products specified by Renesas as suitable for automobile applications, Renesas products are not designed, manufactured or tested for applications or otherwise in systems the failure or malfunction of which may cause a direct threat to human life or create a risk of human injury or which require especially high quality and reliability such as safety systems, or equipment or systems for transportation and traffic, healthcare, combustion control, aerospace and aeronautics, nuclear power, or undersea communication transmission. If you are considering the use of our products for such purposes, please contact a Renesas sales office beforehand. Renesas shall have no liability for damages arising out of the uses set forth above.
8. Notwithstanding the preceding paragraph, you should not use Renesas products for the purposes listed below:
  - (1) artificial life support devices or systems
  - (2) surgical implantations
  - (3) healthcare intervention (e.g., excision, administration of medication, etc.)
  - (4) any other purposes that pose a direct threat to human lifeRenesas shall have no liability for damages arising out of the uses set forth in the above and purchasers who elect to use Renesas products in any of the foregoing applications shall indemnify and hold harmless Renesas Technology Corp., its affiliated companies and their officers, directors, and employees against any and all damages arising out of such applications.
9. You should use the products described herein within the range specified by Renesas, especially with respect to the maximum rating, operating supply voltage range, movement power voltage range, heat radiation characteristics, installation and other product characteristics. Renesas shall have no liability for malfunctions or damages arising out of the use of Renesas products beyond such specified ranges.
10. Although Renesas endeavors to improve the quality and reliability of its products, IC products have specific characteristics such as the occurrence of failure at a certain rate and malfunctions under certain use conditions. Please be sure to implement safety measures to guard against the possibility of physical injury, and injury or damage caused by fire in the event of the failure of a Renesas product, such as safety design for hardware and software including but not limited to redundancy, fire control and malfunction prevention, appropriate treatment for aging degradation or any other applicable measures. Among others, since the evaluation of microcomputer software alone is very difficult, please evaluate the safety of the final products or system manufactured by you.
11. In case Renesas products listed in this document are detached from the products to which the Renesas products are attached or affixed, the risk of accident such as swallowing by infants and small children is very high. You should implement safety measures so that Renesas products may not be easily detached from your products. Renesas shall have no liability for damages arising out of such detachment.
12. This document may not be reproduced or duplicated, in any form, in whole or in part, without prior written approval from Renesas.
13. Please contact a Renesas sales office if you have any questions regarding the information contained in this document, Renesas semiconductor products, or if you have any other inquiries.



**RENESAS SALES OFFICES**

<http://www.renesas.com>

Refer to "<http://www.renesas.com/en/network>" for the latest and detailed information.

**Renesas Technology America, Inc.**  
450 Holger Way, San Jose, CA 95134-1368, U.S.A  
Tel: <1> (408) 382-7500, Fax: <1> (408) 382-7501

**Renesas Technology Europe Limited**  
Dukes Meadow, Millboard Road, Bourne End, Buckinghamshire, SL8 5FH, U.K.  
Tel: <44> (1628) 585-100, Fax: <44> (1628) 585-900

**Renesas Technology (Shanghai) Co., Ltd.**  
Unit 204, 205, AZIA Center, No.1233 Lujiazui Ring Rd, Pudong District, Shanghai, China 200120  
Tel: <86> (21) 5877-1818, Fax: <86> (21) 6887-7898

**Renesas Technology Hong Kong Ltd.**  
7th Floor, North Tower, World Finance Centre, Harbour City, 1 Canton Road, Tsimshatsui, Kowloon, Hong Kong  
Tel: <852> 2265-6688, Fax: <852> 2730-6071

**Renesas Technology Taiwan Co., Ltd.**  
10th Floor, No.99, Fushing North Road, Taipei, Taiwan  
Tel: <886> (2) 2715-2888, Fax: <886> (2) 2713-2999

**Renesas Technology Singapore Pte. Ltd.**  
1 Harbour Front Avenue, #06-10, Keppel Bay Tower, Singapore 098632  
Tel: <65> 6213-0200, Fax: <65> 6278-8001

**Renesas Technology Korea Co., Ltd.**  
Kukje Center Bldg. 18th Fl., 191, 2-ka, Hangang-ro, Yongsan-ku, Seoul 140-702, Korea  
Tel: <82> (2) 796-3115, Fax: <82> (2) 796-2145

**Renesas Technology Malaysia Sdn. Bhd**  
Unit 906, Block B, Menara Amcorp, Amcorp Trade Centre, No.18, Jalan Persiaran Barat, 46050 Petaling Jaya, Selangor Darul Ehsan, Malaysia  
Tel: <603> 7955-9390, Fax: <603> 7955-9510