

INTRODUCTION

The S5C7212X01 is a CMOS integrated circuit designed for making various timing pulses for B/W CCD camera.

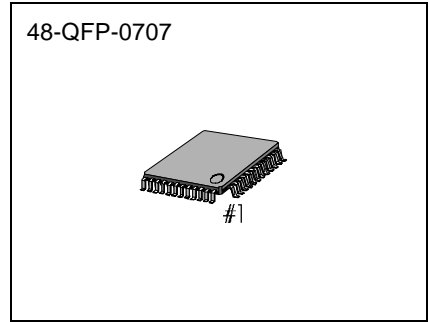

FEATURES

- Compatible with both EIA and CCIR mode
(EIA : S5F325NW02 / S5F325NU02
CCIR : S5F329PW02 / S5F329PU02)
- Built in auto iris function (Electronic Exposure)
- Mirror mode timing generation
- Field interlace mode only
- Timing and sync one chip IC
- Oscillation frequency
EIA : 19.06992MHz, CCIR : 18.93750MHz

ORDERING INFORMATION

Device	Package	Operating
S5C7212X01-E0R0	48-QFP-0707	-20 °C – 75 °C

APPLICATION

- B/W CCD Camera

BLOCK DIAGRAM

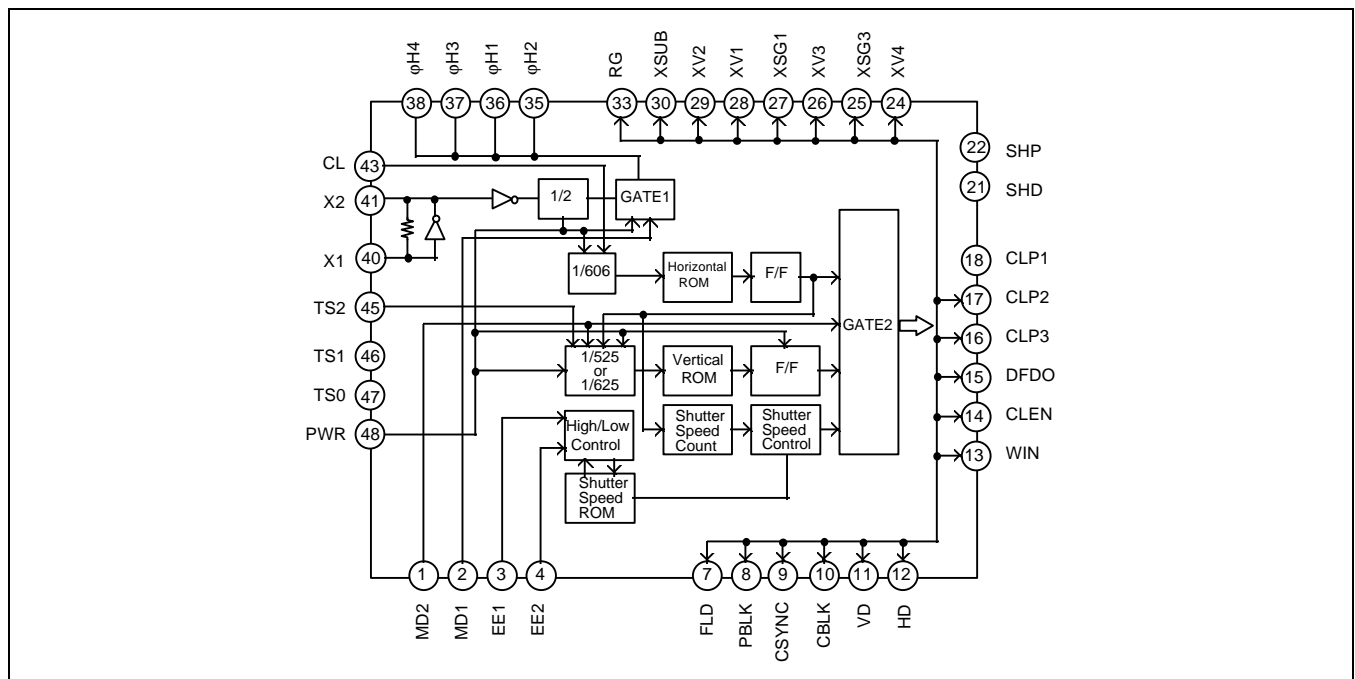

PIN DESCRIPTION

No	Symbol	I/O	Description	Remark
1	MD2	I	CCIR/EIA mode selection	* Information (1)
2	MD1	I	NORMAL/MIRROR mode selection	* Information (1)
3	EE1	I	EE mode control input 1	* Information (2)
4	EE2	I	EE mode control input 2	* Information (2)
5	VSS1	-	Ground	
6	VDD1	-	+5V	
7	FLD	O	Field separation pulse	
8	PBLK	O	Pre - blanking pulse	
9	CSYNC	O	Composite Sync.pulse	
10	CBLK	O	Composite Blanking pulse	
11	VD	O	Vertical driving pulse	
12	HD	O	Horizontal driving pulse	
13	WIN	O	Window pulse	
14	CLEN	O	1/2 HD frequency pulse	
15	DFDO	O	1/2 VD frequency pulse	
16	CLP3	O	Clamp pulse 3 (Dummy black level)	
17	CLP2	O	Clamp pulse 2 (Optical black level)	
18	CLP1	O	Clamp pulse 1 (Optical black level)	
19	VSS2	-	Ground	
20	VDD2	-	+5V	
21	SHD	O	Data Sample & Hold pulse	
22	SHP	O	Pre - Charge Sample & Hold pulse	
23	VSS3	-	Ground	
24	XV4	O	Vertical transfer clock 4	
25	XSG3	O	Read out Pulse 3	
26	V3	O	Vertical transfer clock 3	
27	XSG1	O	Read out Pulse 1	
28	XV1	O	Vertical transfer clock 1	
29	XV2	O	Vertical transfer clock 2	
30	XSUB	O	Shutter speed control for auto iris	
31	VDD3	-	+5V	
32	VSS4	-	Ground	

No	Symbol	I/O	Description	Remark
33	ϕ RG	O	Reset gate pulse	
34	VDD4	-	+5V	
35	ϕ H2	O	Horizontal transfer pulse 2 (Mirror mode)	
36	ϕ H1	O	Horizontal transfer pulse 1 (Normal modeH1)	
37	ϕ H3	O	Horizontal transfer pulse 3 (Normal modeH2)	
38	ϕ H4	O	Horizontal transfer pulse 4 (Mirror mode)	
39	VSS5	-	Ground	
40	X1	I	Oscillation clock Input EIA : 19,069928MHz CCIR : 18.93750MHz	
41	X2	O	Oscillation clock Output	
42	VDD5	O	+5V	
43	CL	O	1/2 Oscillation clock EIA : 9.53496MHz CCIR : 9.46875MHz	
44	VSS6	-	Ground	
45	TS2	I	Test Input 2	
46	TS1	I	Test Input 1	
47	TS0	I	Test Input 0	
48	PWR	-	Power On Reset	

Information 1) MD2 and MD1 mode selection (Pull - down)

MD2	MD1	MODE
L	L	EIA NORMAL
	H	EIA MIRROR
H	L	CCIR NORMAL
	H	CCIR MIRROR

Information 2) EE2 and EE1 shutter speed mode selection (Pull - up)

EE2	EE1	MODE
L	L	SHUTTER SPEED STOP
	H	SHUTTER SPEED UP
H	L	SHUTTER SPEED DOWN
	H	SHUTTER SPEED STOP

ABSOLUTE MAXIMUM RATINGS

Characteristics	Symbol	Value	Unit
Supply Voltage	V_{CC}	7	V
Input Voltage	V_I	$V_{SS}-0.5 - V_{DD}+0.5$	V
Output Voltage	V_O	$V_{SS}-0.5 - V_{DD}+0.5$	V
Operating Temperature	T_{OPR}	-20 – +75	°C
Storage Temperature	T_{STG}	-55 – +150	°C

ELECTRICAL CHARACTERISTICS

($V_{DD}=5V$, $T_a=25^\circ C$, unless otherwise specified)

Characteristics	Symbol	Test Condition	Min	Typ	Max	Unit
Supply Voltage	V_{DD}	-	4.75	5.0	5.25	V
Input Voltage 2	V_{IH}	-	$0.7V_{DD}$	-	-	V
	V_{IL}	-	-	-	$0.3V_{DD}$	V
Output Voltage 1	V_{OH1}	$I_{OH1} = -2mA$	$V_{DD}-0.5$	-	-	V
	V_{OL1}	$I_{OL1} = 4mA$	-	-	0.6	V
Output Voltage 2 (CL, RG, SHP, SHD)	V_{OH2}	$I_{OH2} = -4mA$	$V_{DD}-0.5$	-	-	V
	V_{OL2}	$I_{OL2} = 8mA$	-	-	0.6	V
Output Voltage 3 (H1, H2, H3, H4)	V_{OH3}	$I_{OH3} = -8mA$	$V_{DD}-0.5$	-	-	V
	V_{OL3}	$I_{OL3} = 8mA$	-	-	0.6	V

AC CHARACTERISTICS

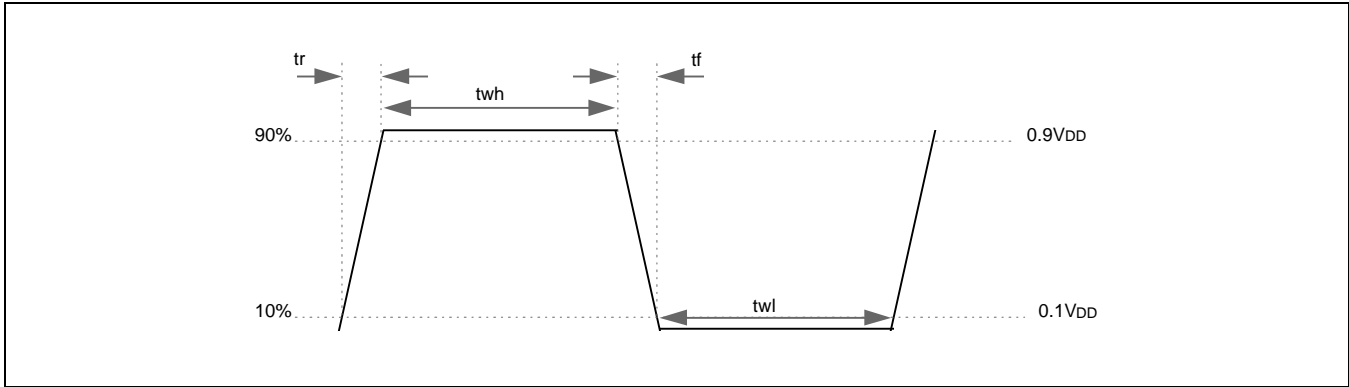

PULSES	twh			twl			tr			tf			Unit
	Min.	Typ.	Max.	Min.	Typ.	Max.	Min.	Typ.	Max.	Min.	Typ.	Max.	
XSG1, XSG3	2.3	2.5						0.5			0.5		us
XV1, XV2, XV3, XV4								0.015			0.24		us
H1, H2, H3, H4	26	32		26	32			11	12		11	12	ns
RG	11	13			51			5			5		ns
XSUB	1.5	2.0							0.5			0.5	us
SHP, SHD, CLP1, CLP2, CLP3, DFD0, CLEN, WIN, HD, VD, CBLK, CSYNC, FLD							13	14	16	13	14	16	ns

OPERATING PRINCIPLES & METHODS

POWER ON RESET

S5C7212X01 has two reset methods. The one is power on reset and the other is normal reset.

When user wants to use power on reset, which generates an automatic reset signal that is needed to initialize the S5C7212X01 internal system when power is on, user should connect the 1000pF capacitor to the PWR (pin 48) terminal.

Power on reset system has an internal 100Kohm pull up resistor. So, user can control reset signal timing when user changes the value of the capacitor, which is connected to the PWR terminal.

When user wants to use normal reset, user should remove the capacitor from the PWR terminal, and supply the reset signal to the PWR terminal.

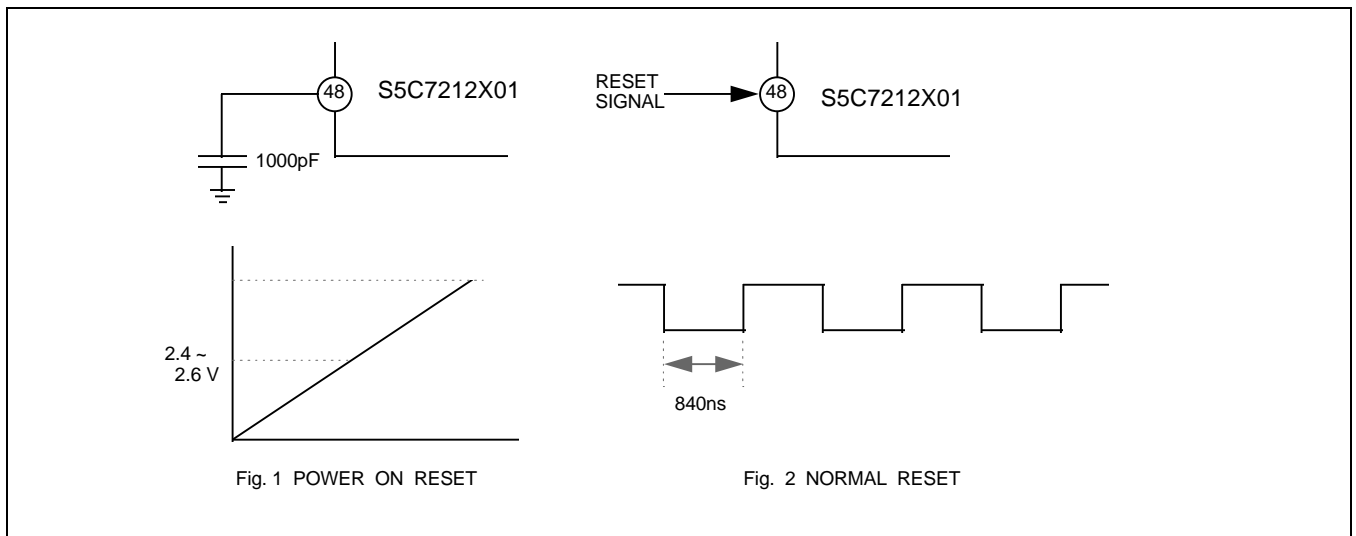

When using the u-Com system, the reset signal can be supplied three times, and times of 1 signal should be larger than four times of CL clock.

HIGH SPEED TIMING RELATIONSHIP

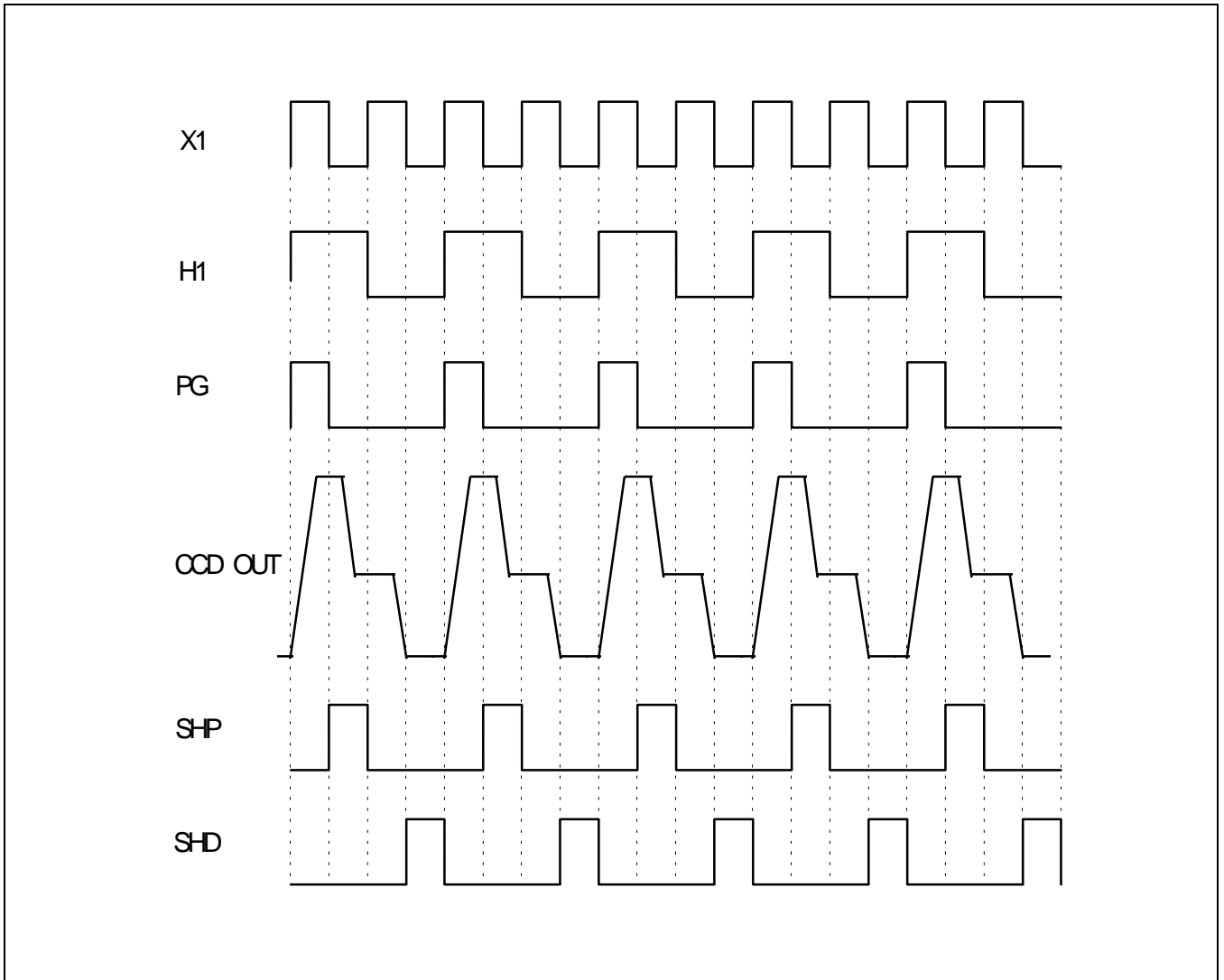

CCD VERTICAL DRIVING PULSE TIMING DIAGRAM

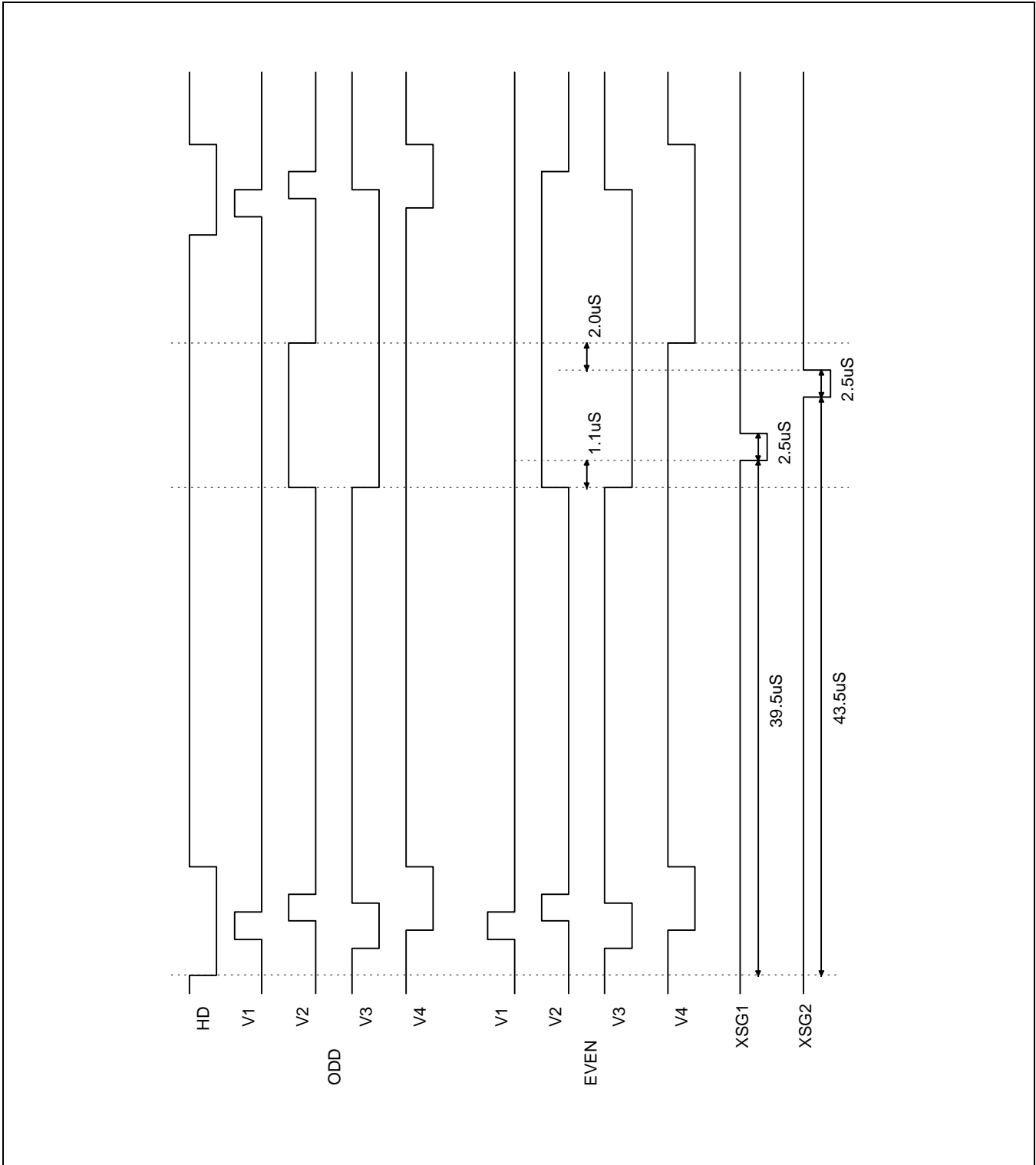

HORIZONTAL TIMING CHART FOR EIA

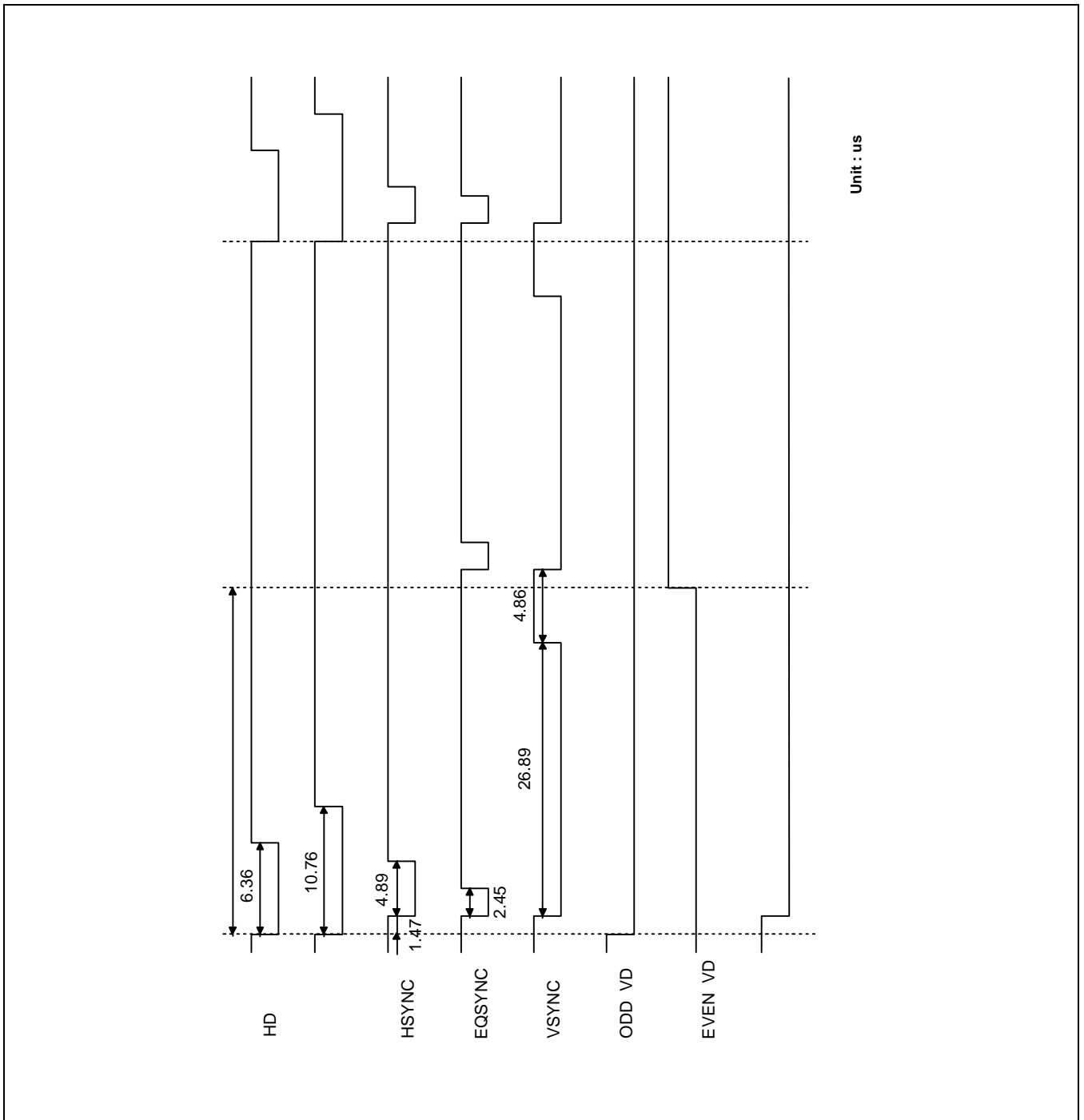

HORIZONTAL TIMING CHART FOR CCIR MODE

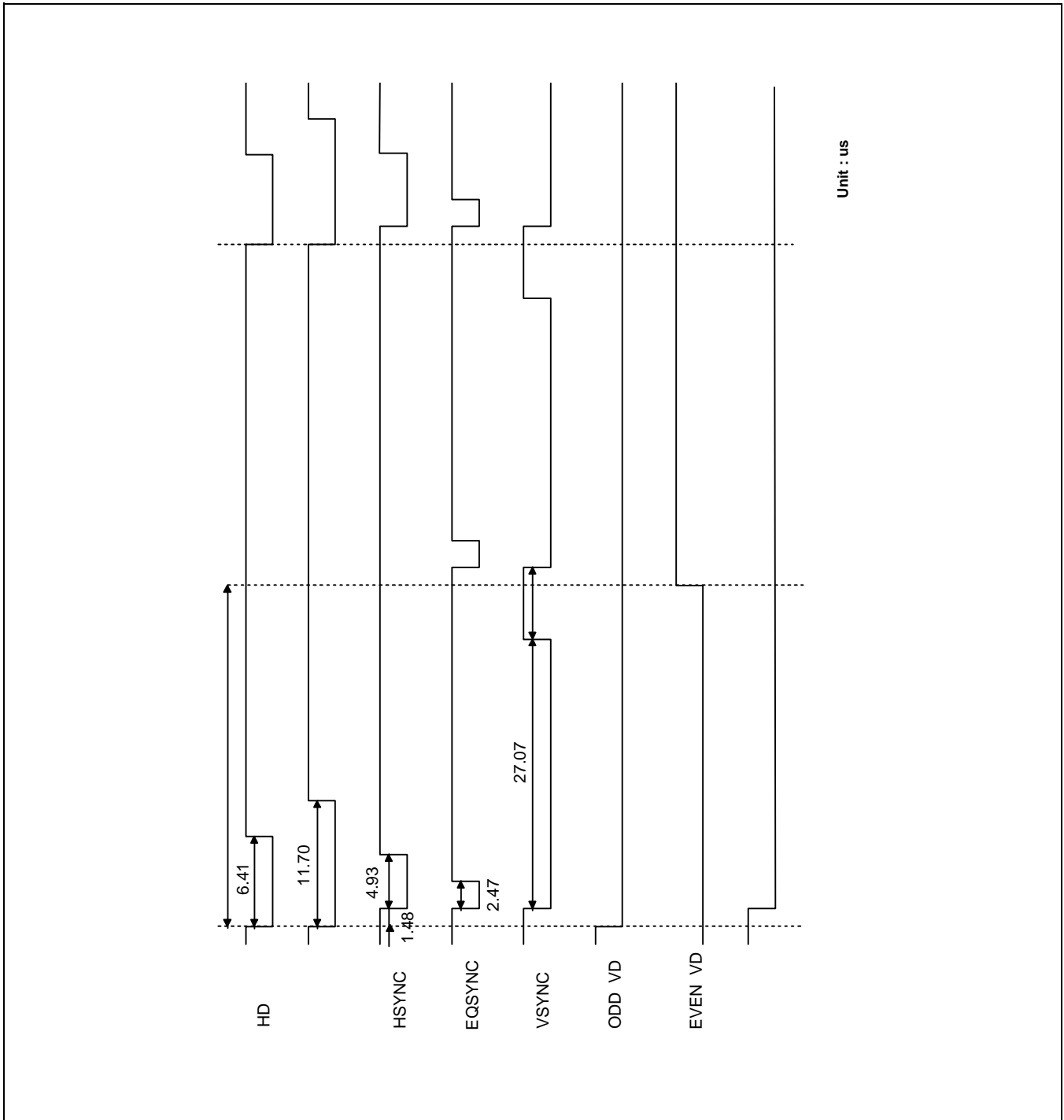

HORIZONTAL TIMING CHART FOR MIRROR EIA MODE

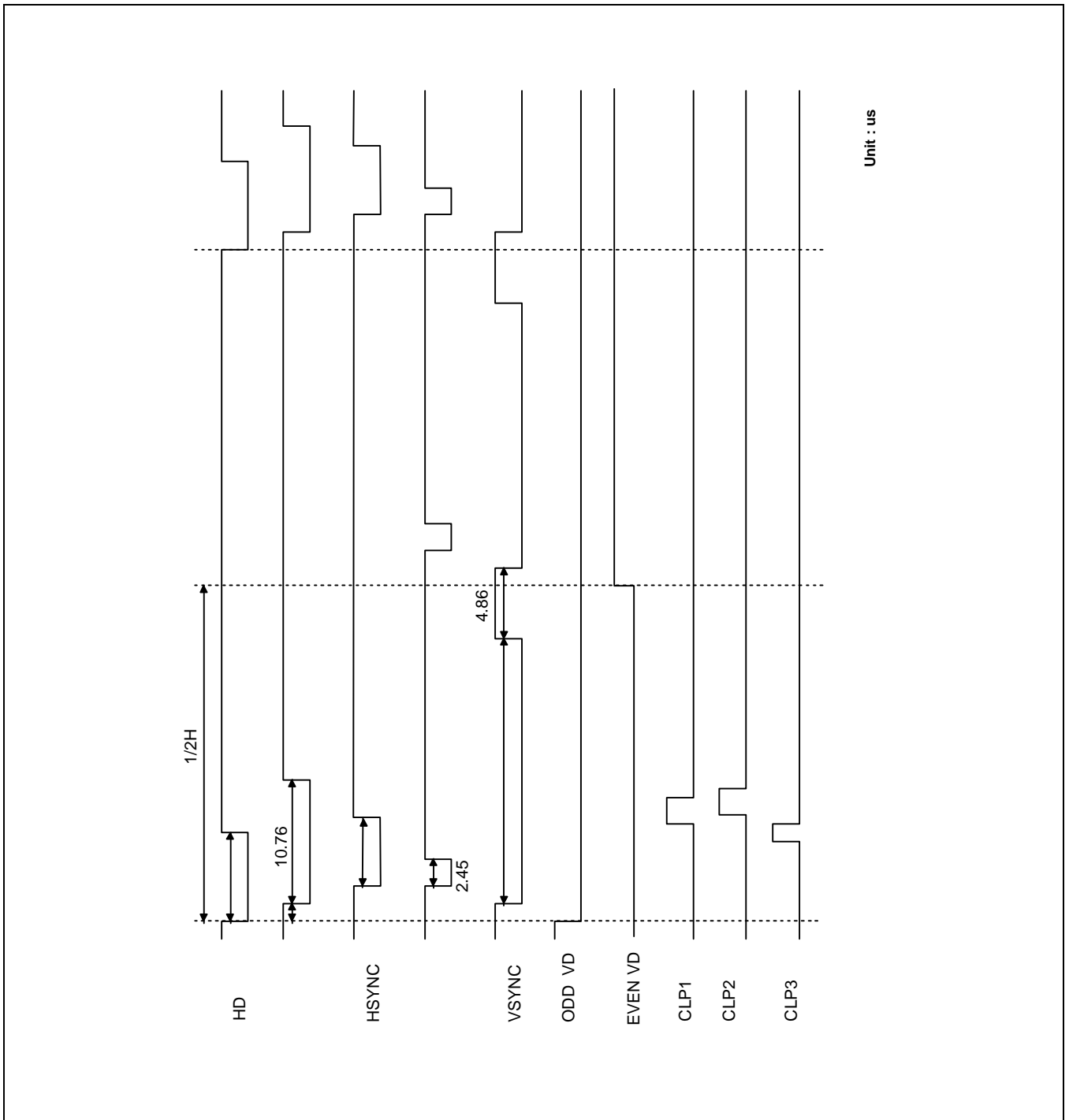

Unit : us

HORIZONTAL TIMING CHART FOR MIRROR CCIR MODE

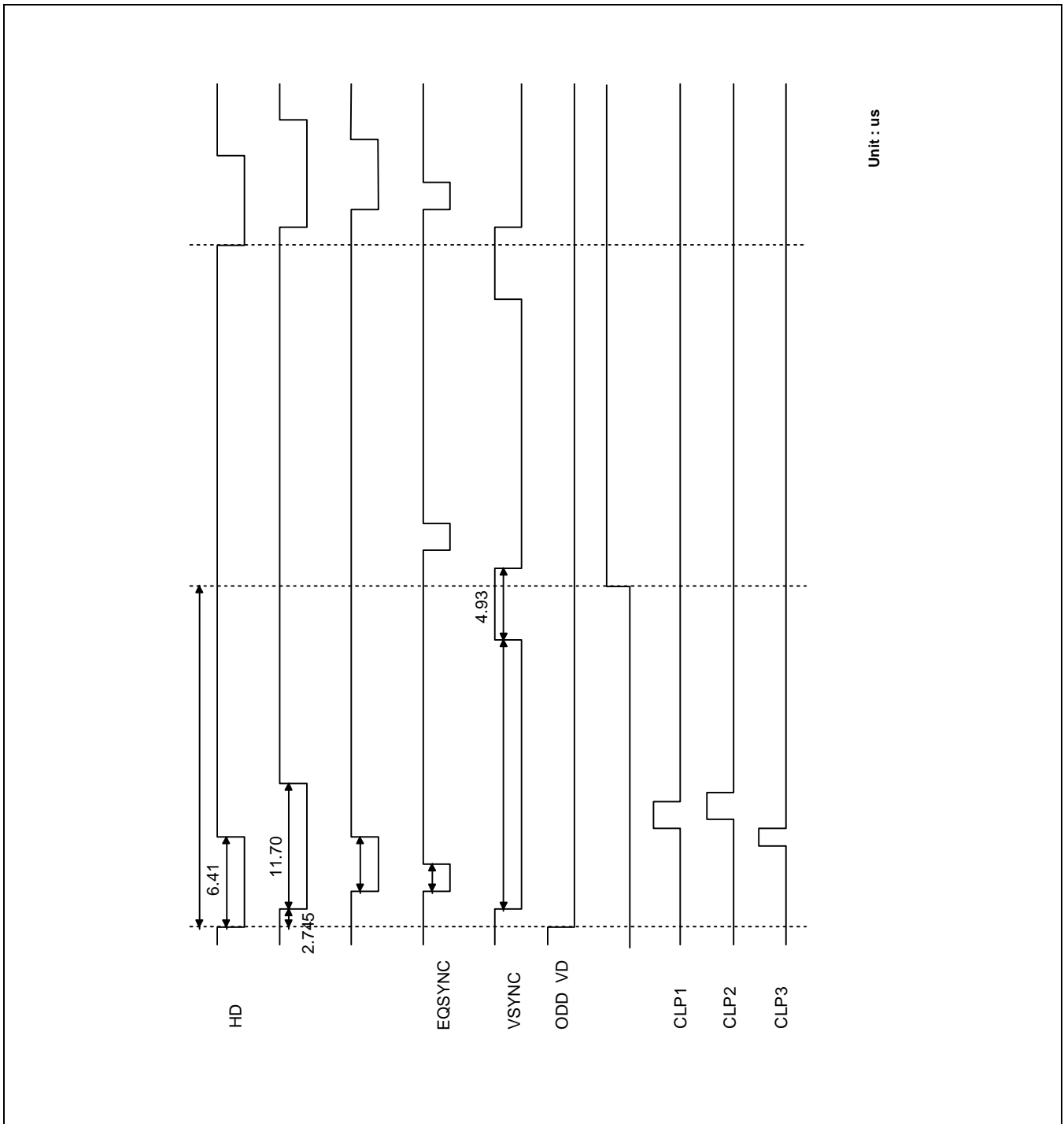

H1, H2, H3, H4, PG, SHP, SHD TIMING CHART AT MIRROR MODE OF CCIR

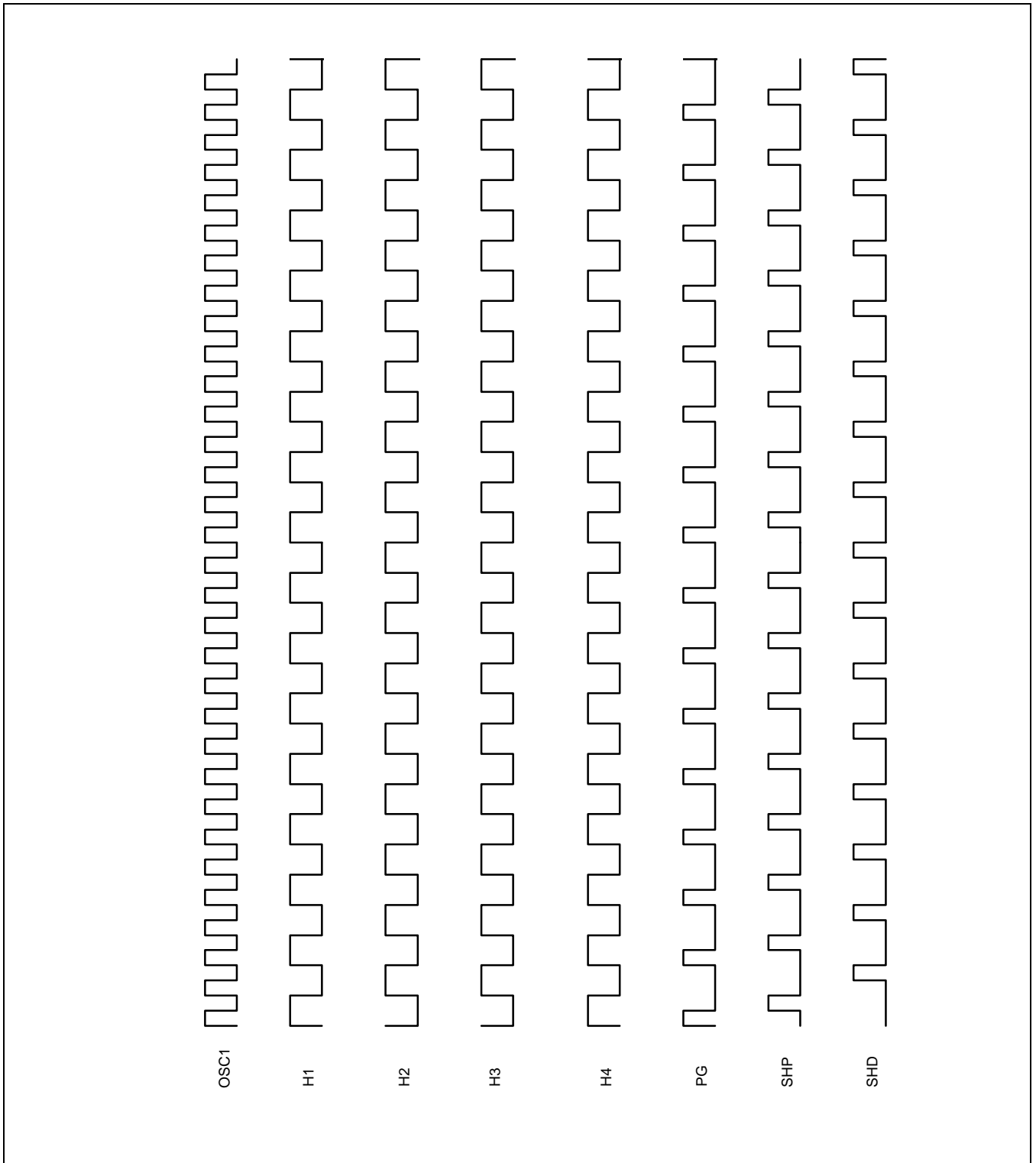

EIA VERTICAL TIMING CHART

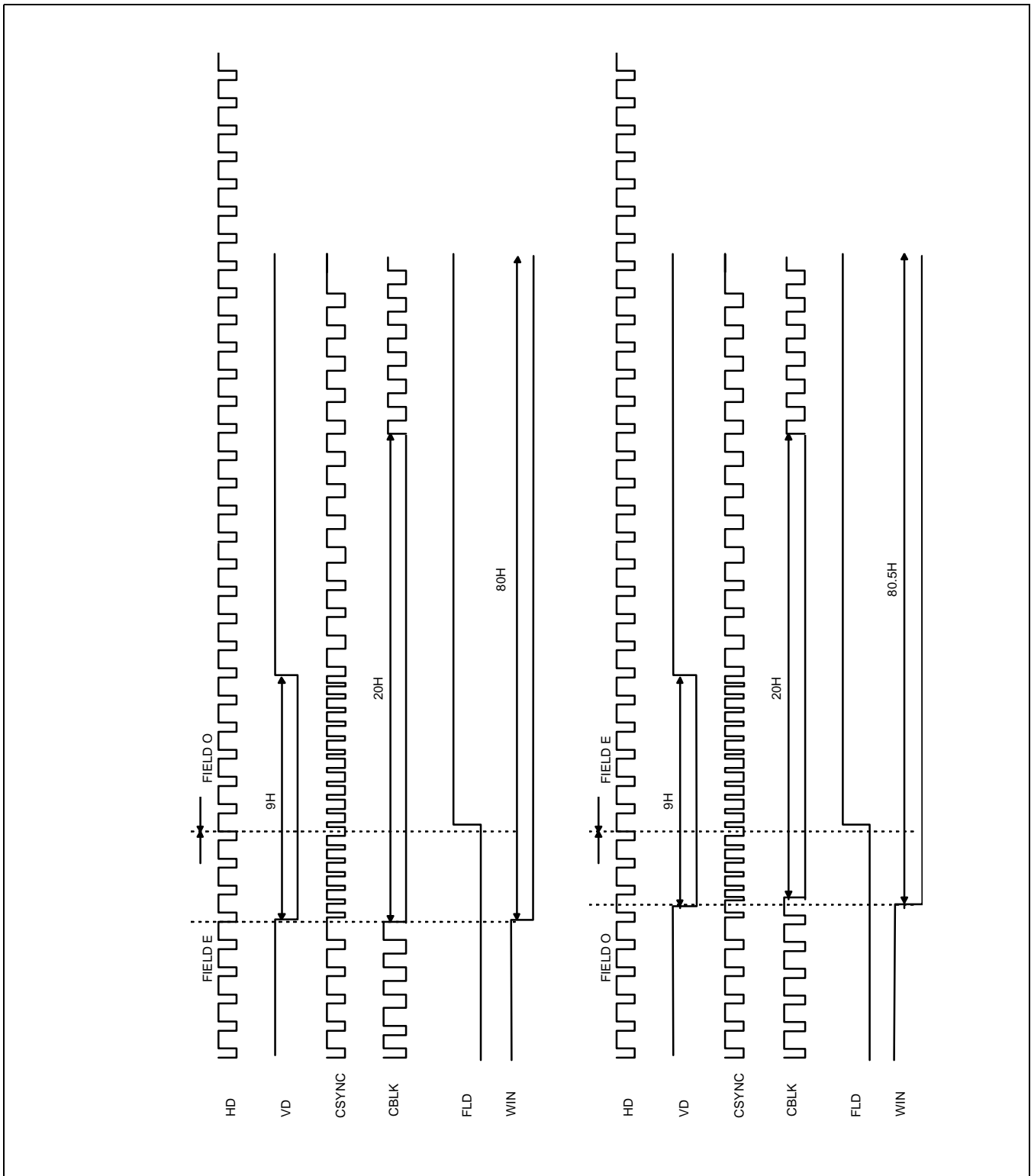

CCIR VERTICAL TIMING CHART

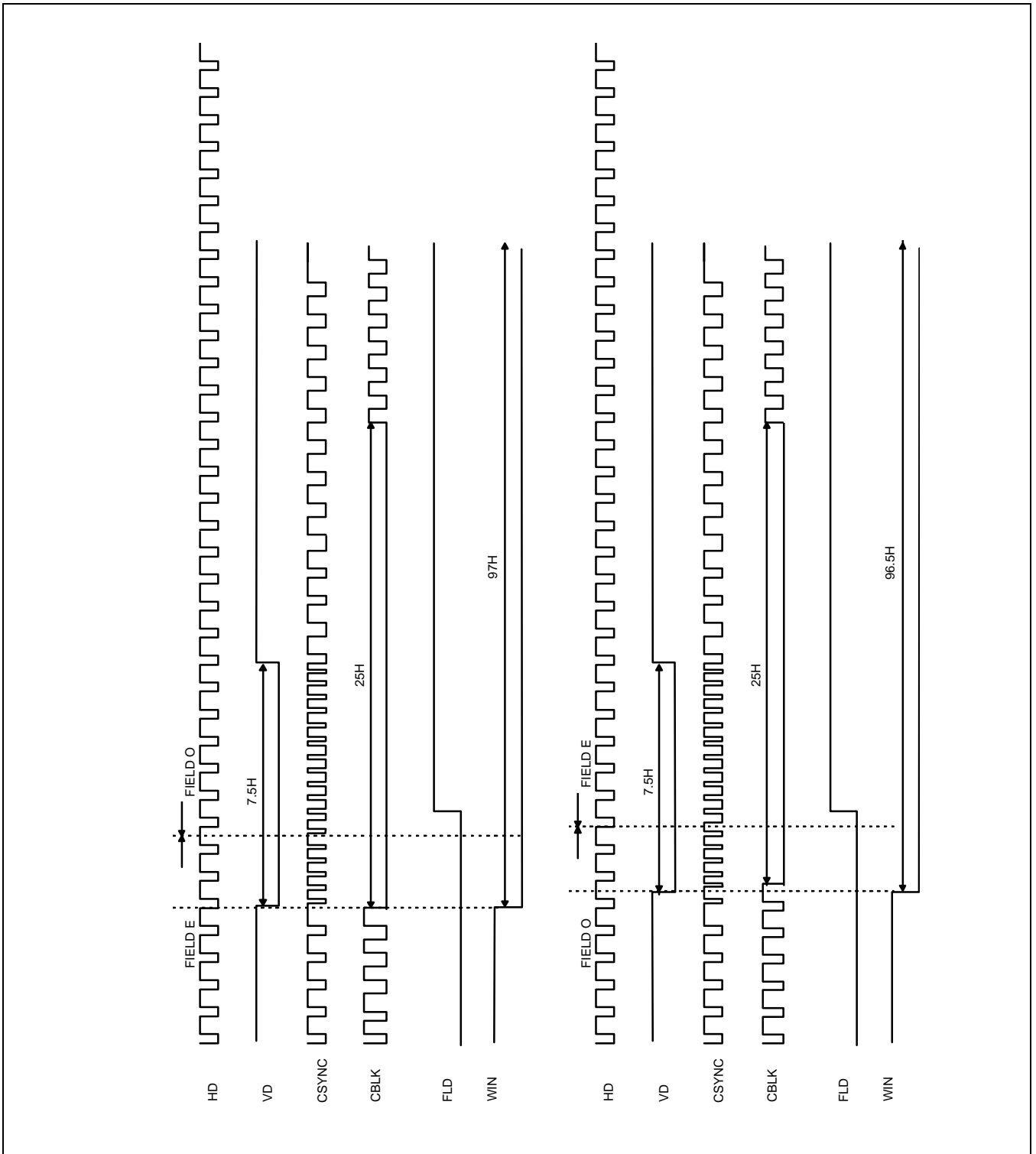

VERTICAL TIMING CHART FOR EIA

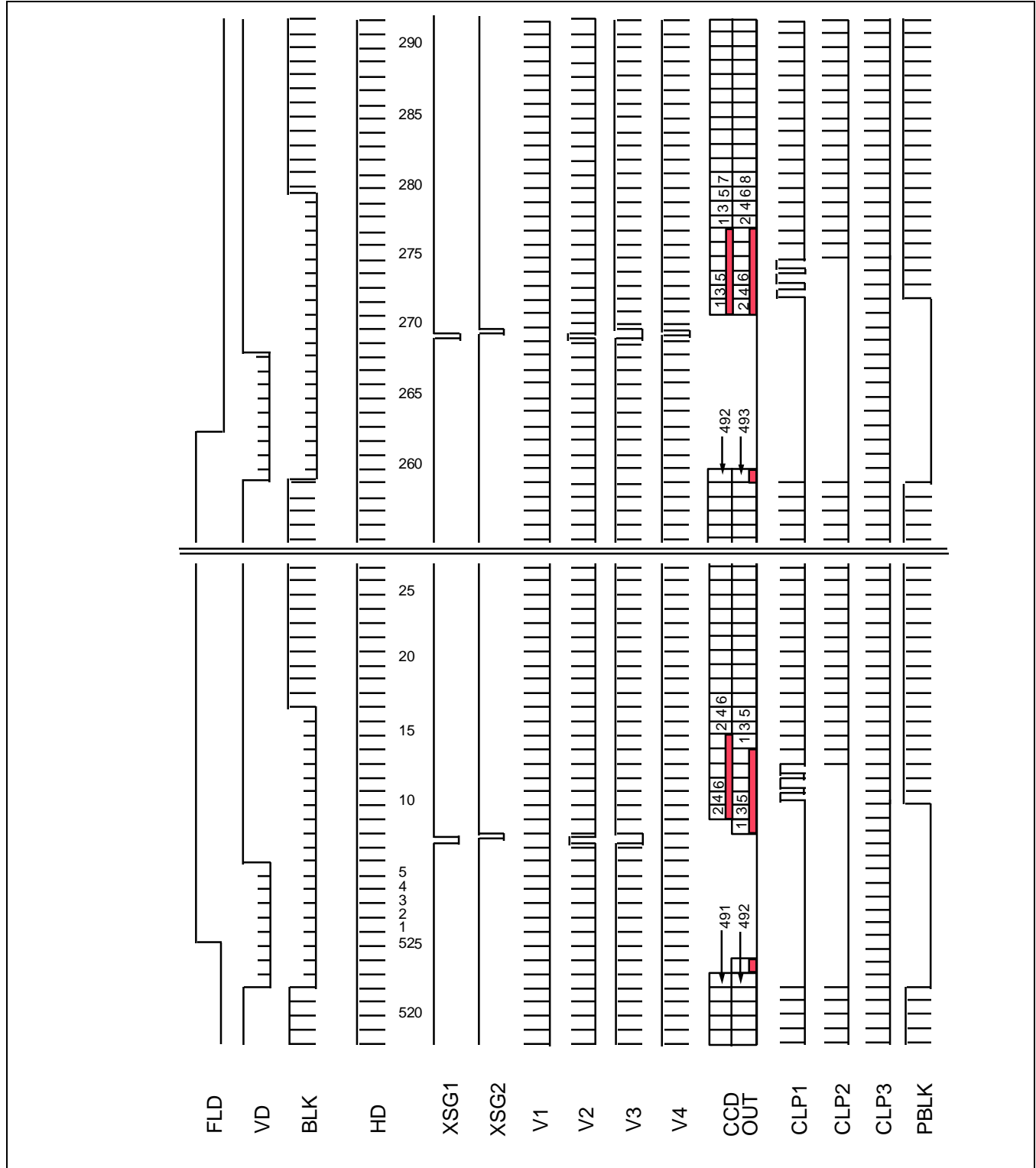

VERTICAL TIMING CHART FOR CCIR

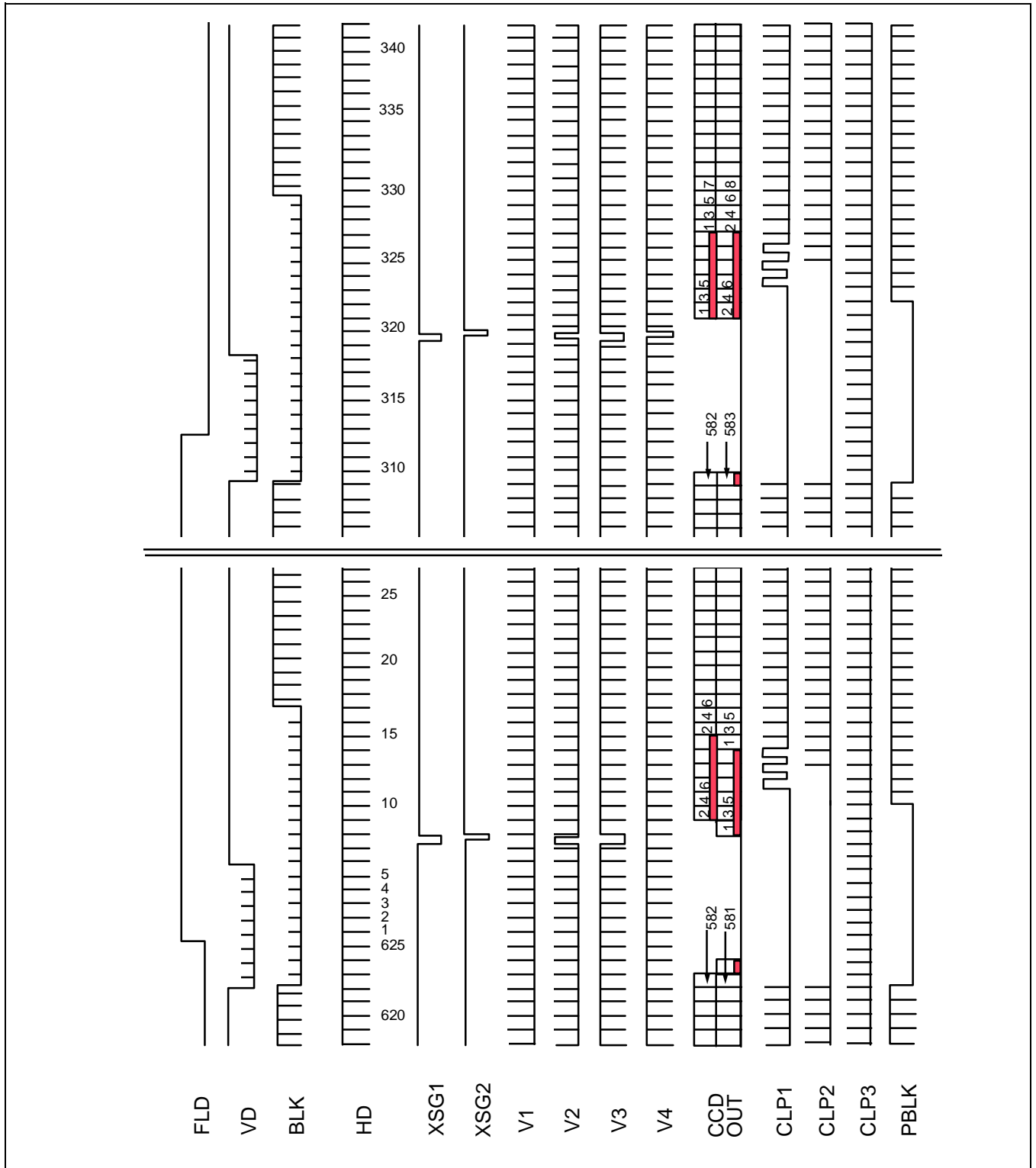

PACKAGE DIMENSION

