

### Features

- Schottky Barrier Chip
- Guard Ring Die Construction for Transient Protection
- High Current Capability
- Low Power Loss, High Efficiency
- High Surge Current Capability
- For Use in Low Voltage, High Frequency Inverters, Free Wheeling, and Polarity Protection Applications

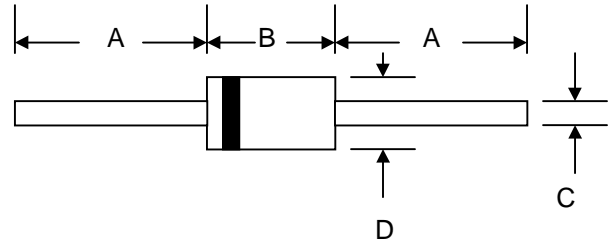

### Mechanical Data

- Case: DO-41, Molded Plastic
- Terminals: Plated Leads Solderable per MIL-STD-202, Method 208
- Polarity: Cathode Band
- Weight: 0.34 grams (approx.)
- Mounting Position: Any
- Marking: Type Number
- **Lead Free: For RoHS / Lead Free Version, Add "-LF" Suffix to Part Number, See Page 4**

DO-41		
Dim	Min	Max
A	25.4	—
B	4.06	5.21
C	0.71	0.864
D	2.00	2.72
All Dimensions in mm		

### Maximum Ratings and Electrical Characteristics @ $T_A=25^\circ\text{C}$ unless otherwise specified

Single Phase, half wave, 60Hz, resistive or inductive load.  
For capacitive load, derate current by 20%.

Characteristic	Symbol	SR120	SR130	SR140	SR150	SR160	SR180	SR1100	Unit
Peak Repetitive Reverse Voltage	$V_{RRM}$	20	30	40	50	60	80	100	V
Working Peak Reverse Voltage	$V_{RWM}$								
DC Blocking Voltage	$V_R$								
RMS Reverse Voltage	$V_{R(RMS)}$	14	21	28	35	42	56	70	V
Average Rectified Output Current @ $T_L = 100^\circ\text{C}$ (Note 1)	$I_O$	1.0							A
Non-Repetitive Peak Forward Surge Current 8.3ms Single half sine-wave superimposed on rated load (JEDEC Method)	$I_{FSM}$	40							A
Forward Voltage @ $I_F = 1.0\text{A}$	$V_{FM}$	0.50		0.70		0.85			V
Peak Reverse Current @ $T_A = 25^\circ\text{C}$ At Rated DC Blocking Voltage @ $T_A = 100^\circ\text{C}$	$I_{RM}$				0.5 10				mA
Typical Junction Capacitance (Note 2)	$C_j$	110			80				pF
Typical Thermal Resistance (Note 1)	$R_{\theta JL}$ $R_{\theta JA}$				15 50				$^\circ\text{C/W}$
Operating and Storage Temperature Range	$T_j, T_{STG}$	-65 to +150							$^\circ\text{C}$

Note: 1. Valid provided that leads are kept at ambient temperature at a distance of 9.5mm from the case.  
2. Measured at 1.0 MHz and applied reverse voltage of 4.0V D.C.

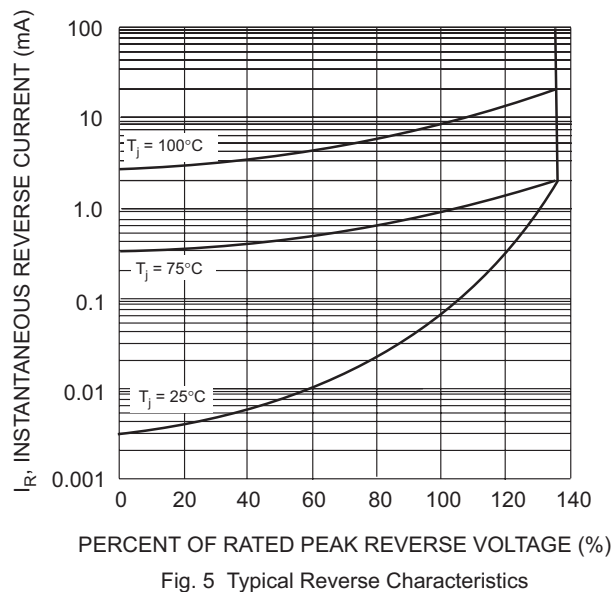
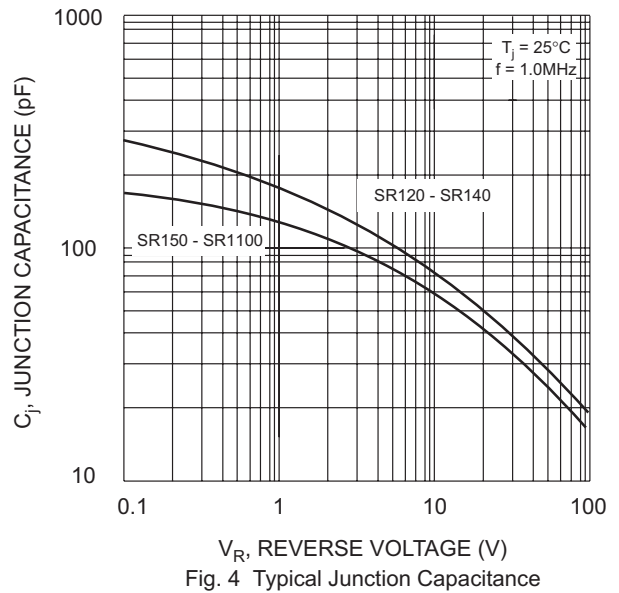
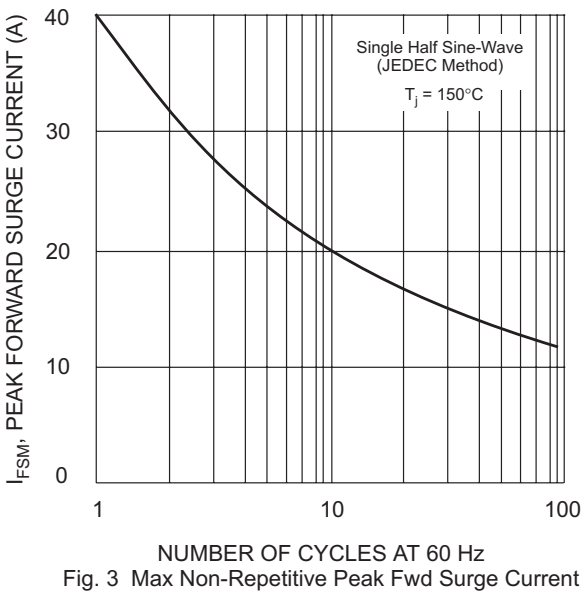
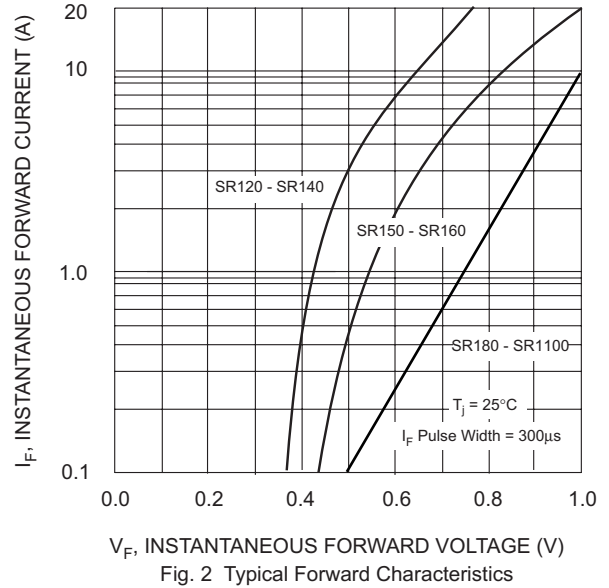
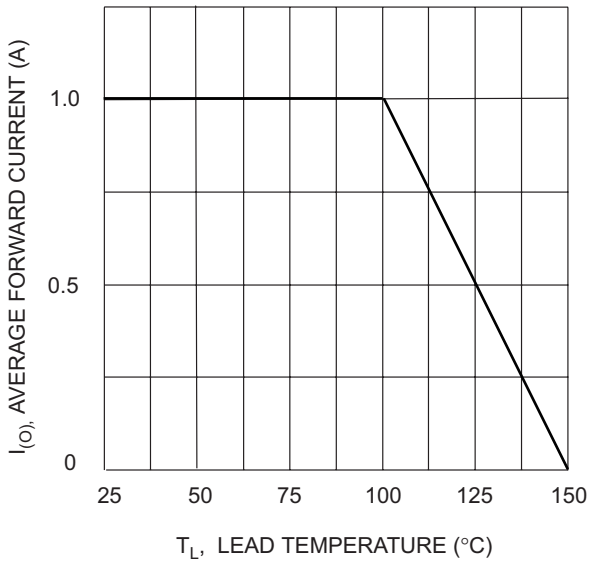

## MARKING INFORMATION

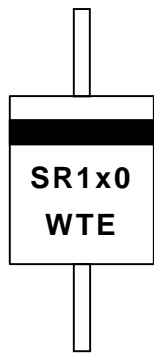

Cathode = Polarity Band  
 SR1x0 = Device Number  
 x = 2, 3, 4, 5, 6, 8 or 10  
 WTE = Manufacturer's Logo

## TAPING SPECIFICATIONS

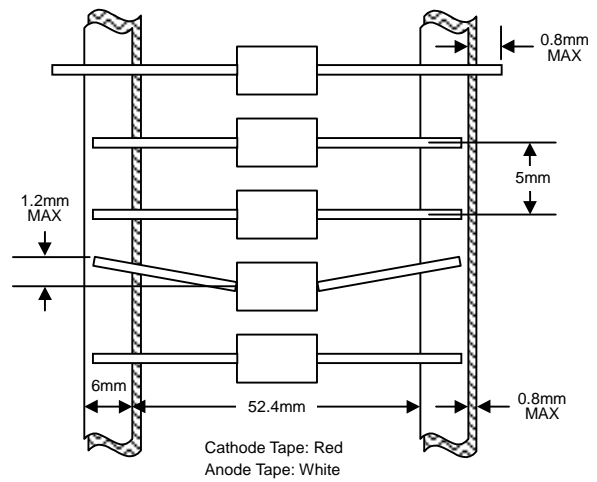

## PACKAGING INFORMATION

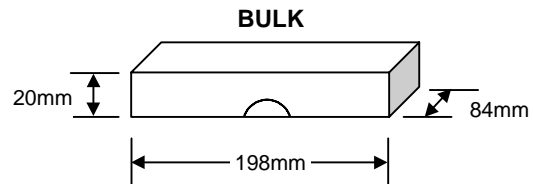

Packaging	Reel Diameter / Box Size (mm)	Quantity (PCS)	Carton Size (mm)	Quantity (PCS)	Approx. Gross Weight (KG)
<b>TAPE &amp; REEL</b>	330	5,000	370 x 370 x 420	25,000	13.0
<b>TAPE &amp; BOX</b>	255 x 75 x 150	5,000	400 x 273 x 415	50,000	21.0
<b>BULK</b>	198 x 84 x 20	1,000	459 x 214 x 256	50,000	19.5

**Note:** 1. Paper reel, white or gray color. Core material: plastic or metal.  
 2. Components are packed in accordance with EIA standard RS-296-E.

## ORDERING INFORMATION

Product No.	Package Type	Shipping Quantity
SR120-T3	DO-41	5000/Tape & Reel
<b>SR120-TB</b>	DO-41	5000/Tape & Box
SR120	DO-41	1000 Units/Box
SR130-T3	DO-41	5000/Tape & Reel
<b>SR130-TB</b>	DO-41	5000/Tape & Box
SR130	DO-41	1000 Units/Box
SR140-T3	DO-41	5000/Tape & Reel
<b>SR140-TB</b>	DO-41	5000/Tape & Box
SR140	DO-41	1000 Units/Box
SR150-T3	DO-41	5000/Tape & Reel
<b>SR150-TB</b>	DO-41	5000/Tape & Box
SR150	DO-41	1000 Units/Box
SR160-T3	DO-41	5000/Tape & Reel
<b>SR160-TB</b>	DO-41	5000/Tape & Box
SR160	DO-41	1000 Units/Box
SR180-T3	DO-41	5000/Tape & Reel
<b>SR180-TB</b>	DO-41	5000/Tape & Box
SR180	DO-41	1000 Units/Box
SR1100-T3	DO-41	5000/Tape & Reel
<b>SR1100-TB</b>	DO-41	5000/Tape & Box
SR1100	DO-41	1000 Units/Box

1. Products listed in **bold** are WTE **Preferred** devices.
2. Shipping quantity given is for minimum packing quantity only. For minimum order quantity, please consult the Sales Department.
3. **To order RoHS / Lead Free version (with Lead Free finish), add "-LF" suffix to part number above. For example, SR120-TB-LF.**

Won-Top Electronics Co., Ltd (WTE) has checked all information carefully and believes it to be correct and accurate. However, WTE cannot assume any responsibility for inaccuracies. Furthermore, this information does not give the purchaser of semiconductor devices any license under patent rights to manufacturer. WTE reserves the right to change any or all information herein without further notice.

**WARNING: DO NOT USE IN LIFE SUPPORT EQUIPMENT.** WTE power semiconductor products are not authorized for use as critical components in life support devices or systems without the express written approval.

**Won-Top Electronics Co., Ltd.**

No. 44 Yu Kang North 3rd Road, Chine Chen Dist., Kaohsiung, Taiwan

**Phone:** 886-7-822-5408 or 886-7-822-5410

**Fax:** 886-7-822-5417

**Email:** sales@wontop.com

**Internet:** http://www.wontop.com

*We power your everyday.*