

***Customer:**

SPECIFICATION

ITEM	TOP LED DEVICE
MODEL	SSC-UHPT801

[Contents]

1. Features	-----	2
2. Absolute Maximum Ratings	-----	2
3. Electro-optical Characteristics	-----	2
4. Soldering Profile	-----	3
5. Outline Dimension	-----	4
6. Packing	-----	4
7. Reel Packing Structure	-----	5
8. Precaution for Use	-----	6
9. Characteristic Diagram	-----	7

Drawn by	Checked by	Approved by

1. Features

- White colored SMT package and colorless clear window
- Material : AlGaInP
- Suitable for all SMT assembly methods; Suitable for all soldering methods

2. Absolute Maximum Ratings ^{*1}

($T_a=25^{\circ}\text{C}$)

Parameter	Symbol	Value	Unit
Power Dissipation	P_d	90	mW
Forward Current	I_F	30	mA
Peak Forward Current	I_{FM} ^{*2}	100	mA
Reverse Voltage	V_R	5	V
Operating Temperature	T_{opr}	-40 ~ +100	$^{\circ}\text{C}$
Storage Temperature	T_{stg}	-40 ~ +100	$^{\circ}\text{C}$

*1 Care is to be taken that power dissipation does not exceed the absolute maximum rating of the product.

*2 I_{FM} was measured at $T_w \leq 0.1\text{msec}$ of pulse width and $D \leq 1/10$ of duty ratio.

3. Electro-Optical Characteristics

($T_a=25^{\circ}\text{C}$)

Parameter	Symbol	Condition	Min	Typ	Max	Unit
Forward Voltage	V_F	$I_F=20\text{mA}$	1.8	2.2	2.6	V
Reverse Current	I_R	$V_R=5\text{V}$	-	-	10	μA
Luminance Intensity ^{*1}	I_V	$I_F=20\text{mA}$	260	320	500	mcd
Peak Wavelength	λ_p	$I_F=20\text{mA}$	-	640	-	nm
Dominant Wavelength	λ_d	$I_F=20\text{mA}$	620	630	636	nm
Spectral Bandwidth 50%	$\Delta\lambda$	$I_F=20\text{mA}$	-	20	-	nm
Viewing Angle ^{*2}	$2\theta_{1/2}$	$I_F=20\text{mA}$	-	120	-	deg.

*1 The luminous intensity I_V is measured at the peak of the spatial pattern which may not be aligned with the mechanical axis of the LED package.

Luminous Intensity Measurement allowance is $\pm 10\%$.

*2 $2\theta_{1/2}$ was the off-axis where the luminous intensity is 1/2 of the peak intensity.

[Note] All measurements were made under the standardized environment of SSC.

4. Soldering Profile

The LED can be soldered in place using the reflow soldering method.

(1) Lead solder

Preliminary heating to be at maximum 210°C for maximum 2 minutes.

Soldering heat to be at maximum 240°C for maximum 10 seconds.

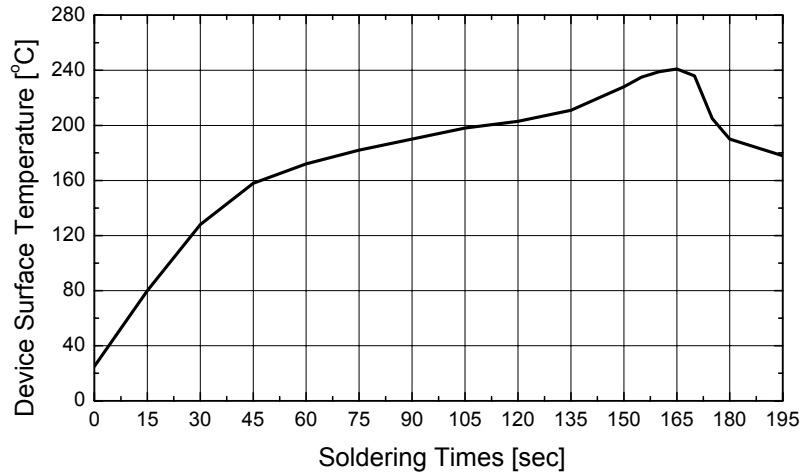

(2) Lead-free solder

Preliminary heating to be at maximum 220°C for maximum 2 minutes.

Soldering heat to be at maximum 260°C for maximum 10 seconds.

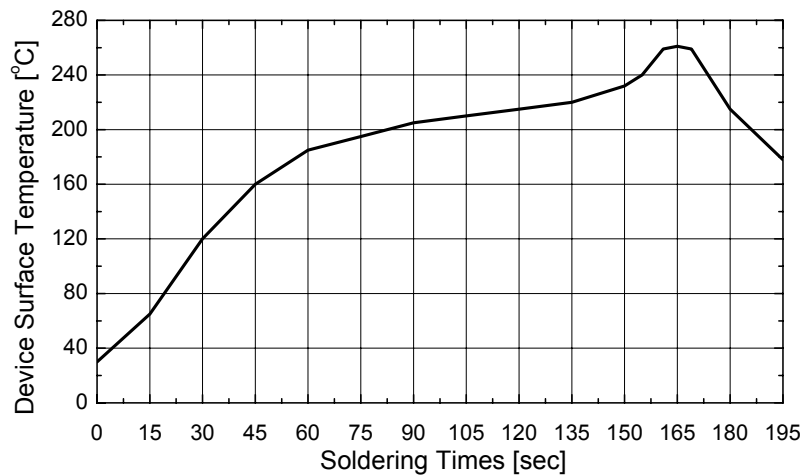

(3) Hand Soldering conditions

Not more than 5 seconds @MAX300°C, under Soldering iron.

In case the soldered products are reused in soldering process, we don't guarantee the products.

5. Outline Dimension

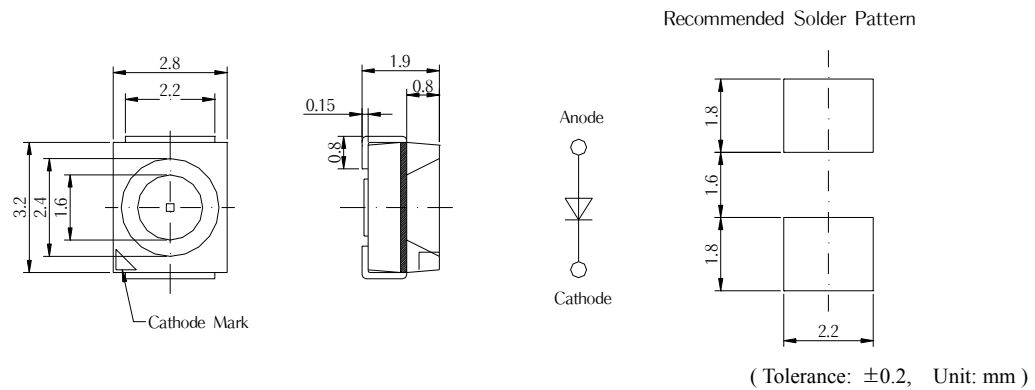

6. Packing

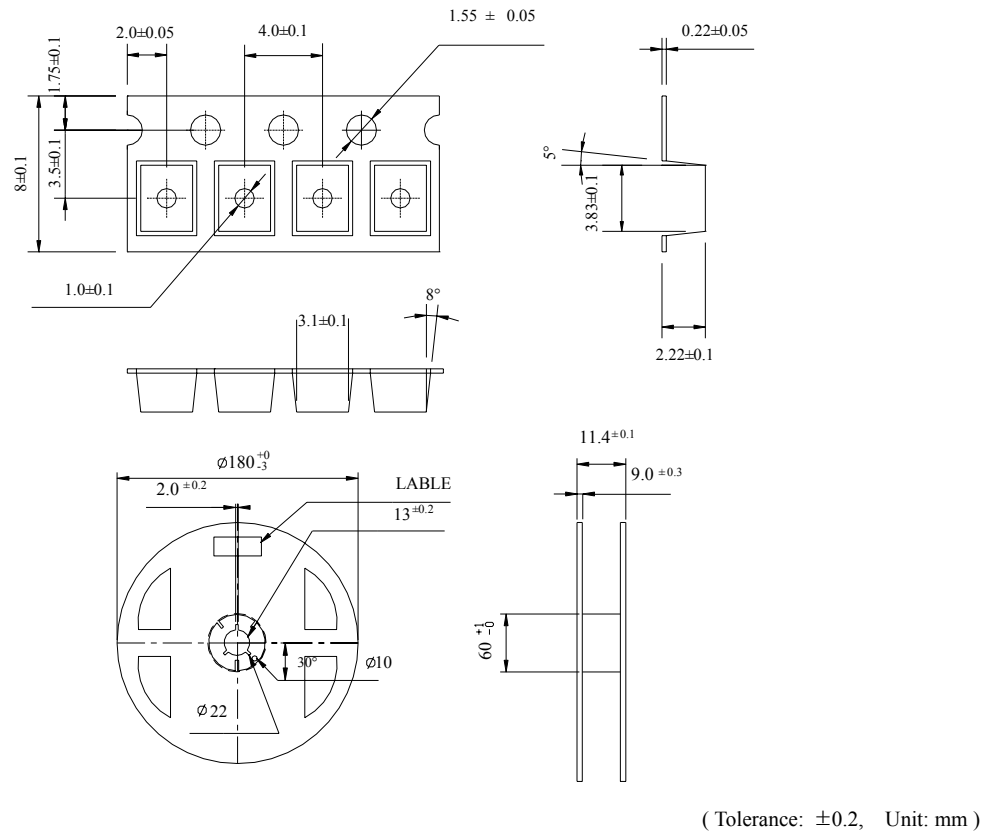

- (1) Quantity : 2000pcs/Reel
- (2) Cumulative Tolerance : Cumulative Tolerance/10 pitches to be ± 0.2 mm
- (3) Adhesion Strength of Cover Tape : Adhesion strength to be 0.1-0.7N when the cover tape is turned off from the carrier tape at the angle of 10° to the carrier tape
- (4) Package : P/N, Manufacturing data Code No. and quantity to be indicated on a damp proof Package

7. Reel Packing Structure

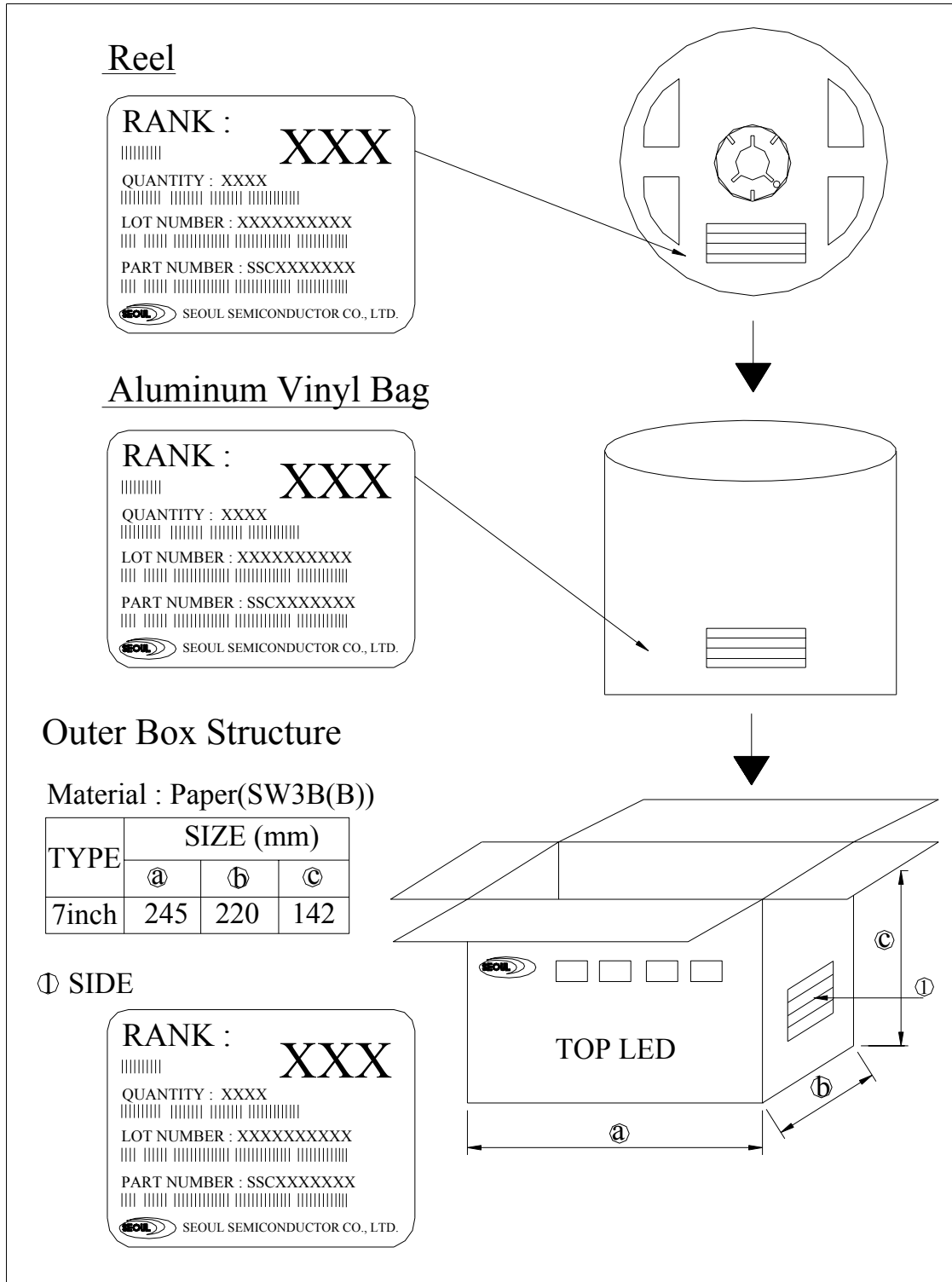

8. Precaution for use

(1) Storage

In order to avoid the absorption of moisture, it is recommended to store in a dry box (or a desiccator) with a desiccant. Otherwise, to store them in the following environment is recommended.

Temperature : 5°C ~30°C Humidity : maximum 65%HR

(2) Attention after open.

LED is correspond to SMD, when LED be soldered dip, interfacial separation may affect the light transmission efficiency, causing the light intensity to drop. Attention in followed;

- a. After opened and mounted the soldering shall be quickly.
- b. Keeping of a fraction

Temperature : 5 ~ 40°C Humidity : less than 30%

(3) In the case of more than 1 week passed after opening or change color of indicator on desiccant, components shall be dried 10-12hr. at 60±5°C.

(4) In the case of that the components is humided, the components shall be dried;

24Hr at 80±5°C or 12Hr at 100±5°C.

(5) Any mechanical force or any excess vibration shall not be accepted to apply during cooling process to normal temperature after soldering.

(6) Quick cooling shall be avoided.

(7) Components shall not be mounted on warped direction of L/F.

(8) Anti radioactive ray design is not considered for the products.

(9) This device should not be used in any type of fluid such as water, oil, organic solvent etc. When washing is required, IPA should be used.

(10) When the LEDs are illuminating, operating current should be decided after considering the ambient maximum temperature.

(11) LEDs must be stored to maintain a clean atmosphere. If the LEDs are stored for 3 months or more after being shipped from SSC, a sealed container with a nitrogen atmosphere should be used for storage.

(12) The LEDs must be soldered within seven days after opening the moisture-proof packing.

(13) Repack unused products with anti-moisture packing, fold to close any opening and then store in a dry place.

(14) The appearance and specifications of the product may be modified for improvement without notice.

9. Characteristic Diagram

Forward Current vs Forward Voltage

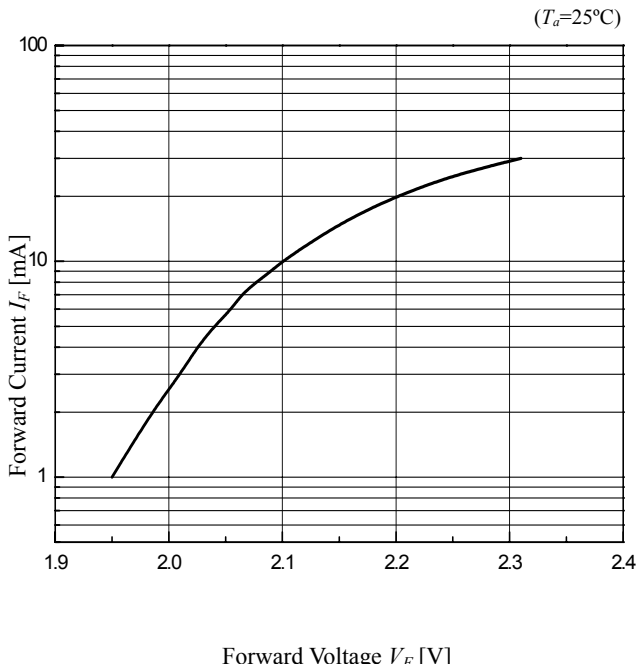

Relative Luminous Intensity vs Forward Current

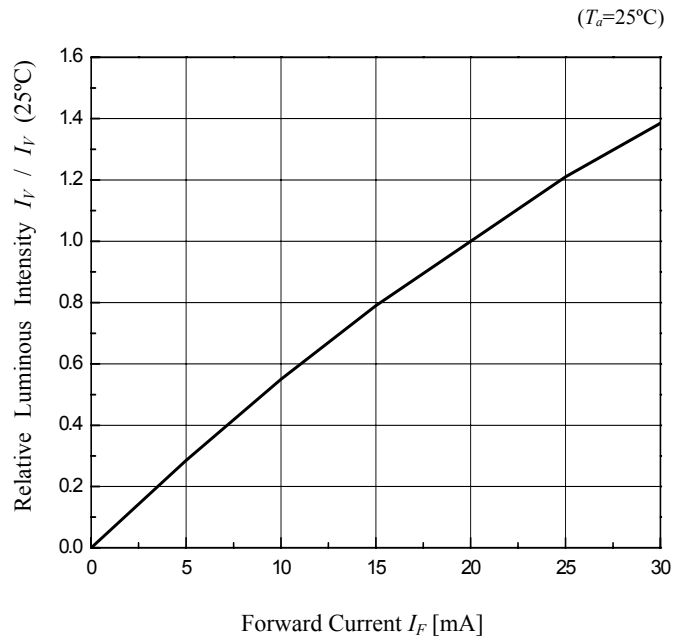

Forward Current Derating Curve

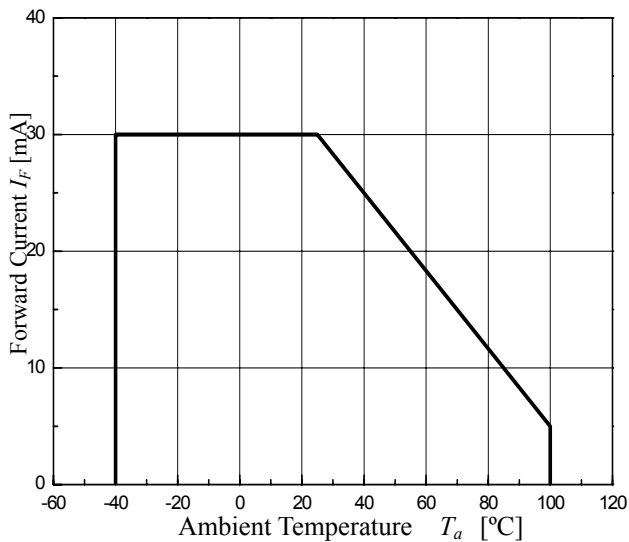

Radiation Diagram

