



STN3NF06

N-CHANNEL 60V - 0.07Ω - 4A SOT-223 STripFET™ II POWER MOSFET

TYPE	V _{DSS}	R _{DS(on)}	I _D
STN3NF06	60 V	< 0.1 Ω	4 A

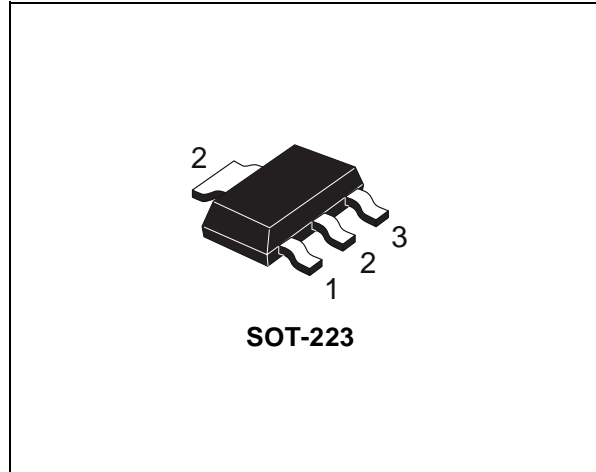
- TYPICAL R_{DS(on)} = 0.07 Ω
- EXCEPTIONAL dv/dt CAPABILITY
- 100% AVALANCHE TESTED
- AVALANCHE RUGGED TECHNOLOGY

DESCRIPTION

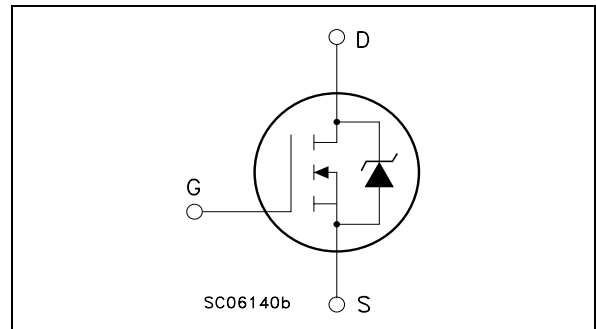
This Power MOSFET is the latest development of STMicroelectronics unique "Single Feature Size™" strip-based process. The resulting transistor shows extremely high packing density for low on-resistance, rugged avalanche characteristics and less critical alignment steps therefore a remarkable manufacturing reproducibility.

APPLICATIONS

- DC-DC & DC-AC CONVERTERS
- DC MOTOR CONTROL (DISK DRIVERS, etc.)
- SYNCHRONOUS RECTIFICATION



INTERNAL SCHEMATIC DIAGRAM



ABSOLUTE MAXIMUM RATINGS

Symbol	Parameter	Value	Unit
V _{DS}	Drain-source Voltage (V _{GS} = 0)	60	V
V _{DGR}	Drain-gate Voltage (R _{GS} = 20 kΩ)	60	V
V _{GS}	Gate- source Voltage	± 20	V
I _D	Drain Current (continuous) at T _C = 25°C	4	A
I _D	Drain Current (continuous) at T _C = 100°C	2.9	A
I _{DM} (●)	Drain Current (pulsed)	16	A
P _{tot}	Total Dissipation at T _C = 25°C	3.3	W
	Derating Factor	0.026	W/°C
dv/dt (1)	Peak Diode Recovery voltage slope	10	V/ns
E _{AS} (2)	Single Pulse Avalanche Energy	200	mJ
T _{stg}	Storage Temperature	-55 to 150	°C
T _j	Operating Junction Temperature		

(●) Pulse width limited by safe operating area.

(1) I_{SD} ≤ 4A, di/dt ≤ 150A/μs, V_{DD} ≤ V_{(BR)DSS}, T_j ≤ T_{JMAX}
 (2) Starting T_j = 25 °C, I_D = 4A, V_{DD} = 30V

STN3NF06

Note: 1. THERMAL DATA

Rthj-pcb	Thermal Resistance Junction-PCB (*)	Max	38	°C/W
Rthj-pcb	Thermal Resistance Junction-PCB (**)	Max	100	°C/W
T _l	Maximum Lead Temperature For Soldering Purpose (for 10 sec. 1.6 mm from case)	Typ	260	°C

(*) When Mounted on FR-4 board with 1 inch² pad, 2 oz of Cu and t ≤ 10 sec

(**) When Mounted on minimum recommended footprint

ELECTRICAL CHARACTERISTICS (T_{case} = 25 °C unless otherwise specified)

OFF

Symbol	Parameter	Test Conditions	Min.	Typ.	Max.	Unit
V _{(BR)DSS}	Drain-source Breakdown Voltage	I _D = 250 μA, V _{GS} = 0	60			V
I _{DSS}	Zero Gate Voltage Drain Current (V _{GS} = 0)	V _{DS} = Max Rating V _{DS} = Max Rating T _C = 125°C			1 10	μA μA
I _{GSS}	Gate-body Leakage Current (V _{DS} = 0)	V _{GS} = ± 20V			±100	nA

ON (1)

Symbol	Parameter	Test Conditions	Min.	Typ.	Max.	Unit
V _{GS(th)}	Gate Threshold Voltage	V _{DS} = V _{GS} I _D = 250 μA	2	3	4	V
R _{DS(on)}	Static Drain-source On Resistance	V _{GS} = 10 V I _D = 1.5 A		0.07	0.10	Ω

DYNAMIC

Symbol	Parameter	Test Conditions	Min.	Typ.	Max.	Unit
g _{fs} (*)	Forward Transconductance	V _{DS} = 15 V I _D = 1.5A		3		S
C _{iss}	Input Capacitance	V _{DS} = 25V, f = 1 MHz, V _{GS} = 0		315		pF
C _{oss}	Output Capacitance			70		pF
C _{rss}	Reverse Transfer Capacitance			30		pF

ELECTRICAL CHARACTERISTICS (continued)

SWITCHING ON

Symbol	Parameter	Test Conditions	Min.	Typ.	Max.	Unit
$t_{d(on)}$ t_r	Turn-on Delay Time Rise Time	$V_{DD} = 30\text{ V}$ $I_D = 1.5\text{ A}$ $R_G = 4.7\ \Omega$ $V_{GS} = 10\text{ V}$ (Resistive Load, Figure 3)		7 18		ns ns
Q_g Q_{gs} Q_{gd}	Total Gate Charge Gate-Source Charge Gate-Drain Charge	$V_{DD} = 48\text{ V}$ $I_D = 3\text{ A}$ $V_{GS} = 10\text{ V}$		10 3.5 3.5	13	nC nC nC

SWITCHING OFF

Symbol	Parameter	Test Conditions	Min.	Typ.	Max.	Unit
$t_{d(off)}$ t_f	Turn-off Delay Time Fall Time	$V_{DD} = 30\text{ V}$ $I_D = 1.5\text{ A}$ $R_G = 4.7\ \Omega$, $V_{GS} = 10\text{ V}$ (Resistive Load, Figure 3)		17 6		ns ns

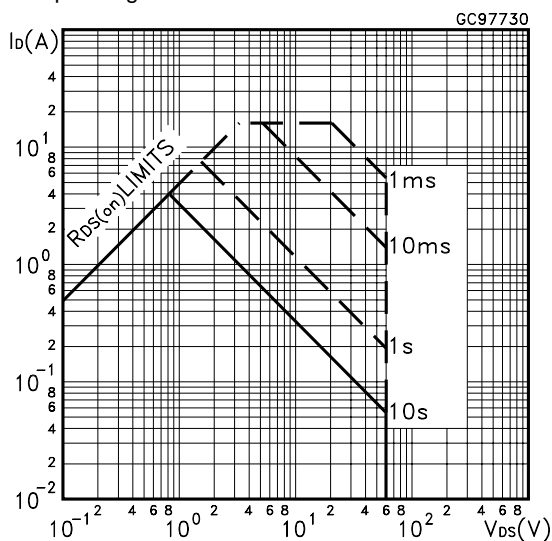
SOURCE DRAIN DIODE

Symbol	Parameter	Test Conditions	Min.	Typ.	Max.	Unit
I_{SD} $I_{SDM} (\bullet)$	Source-drain Current Source-drain Current (pulsed)				4 16	A A
$V_{SD} (*)$	Forward On Voltage	$I_{SD} = 4\text{ A}$ $V_{GS} = 0$			1.3	V
t_{rr} Q_{rr} I_{RRM}	Reverse Recovery Time Reverse Recovery Charge Reverse Recovery Current	$I_{SD} = 4\text{ A}$ $di/dt = 100\text{ A}/\mu\text{s}$ $V_{DD} = 25\text{ V}$ $T_j = 150^\circ\text{C}$ (see test circuit, Figure 5)		50 88 3.5		ns nC A

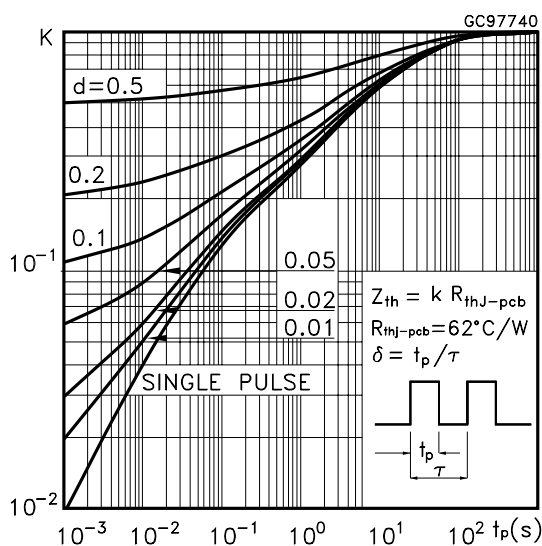
(*) Pulsed: Pulse duration = 300 μs , duty cycle 1.5 %.

(\bullet) Pulse width limited by safe operating area.

Safe Operating Area

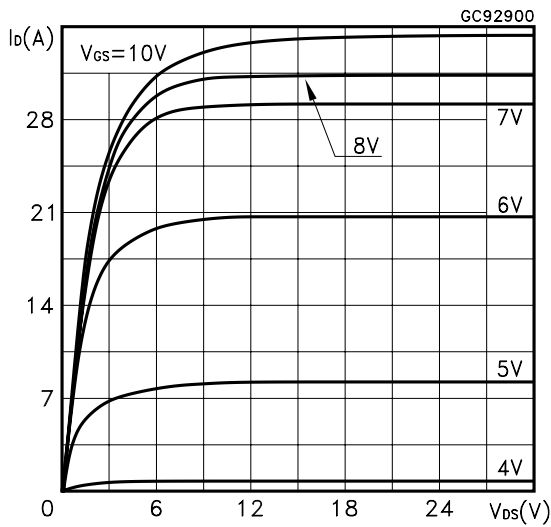


Thermal Impedance

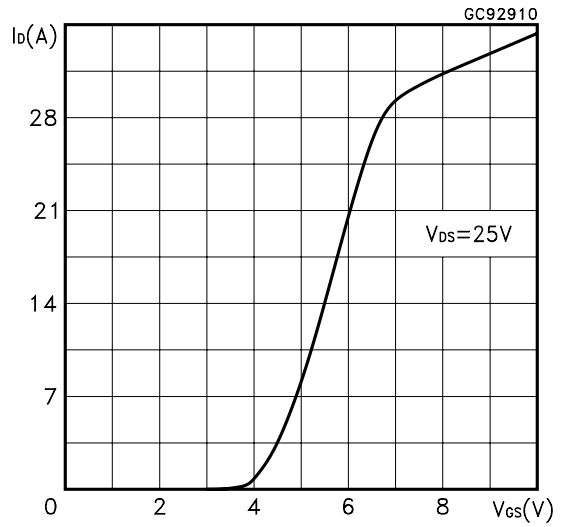


STN3NF06

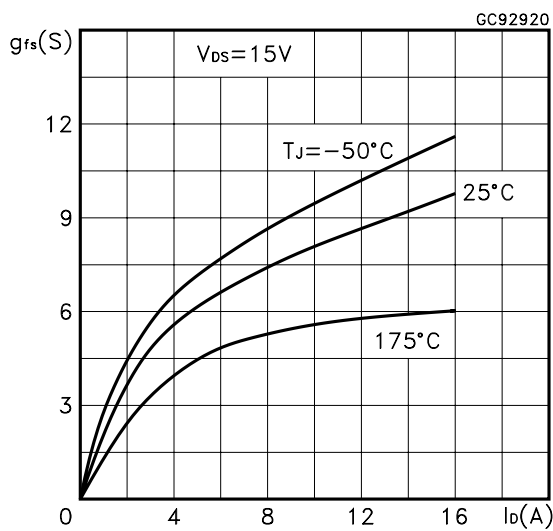
Output Characteristics



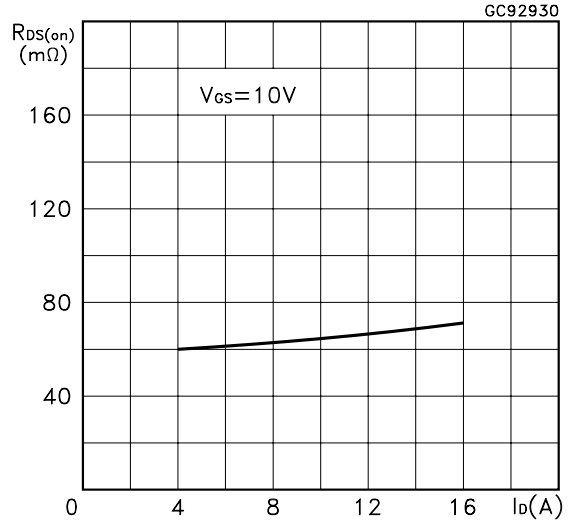
Transfer Characteristics



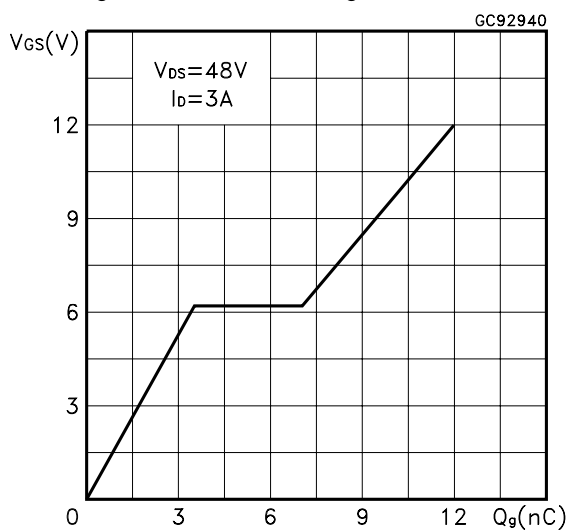
Transconductance



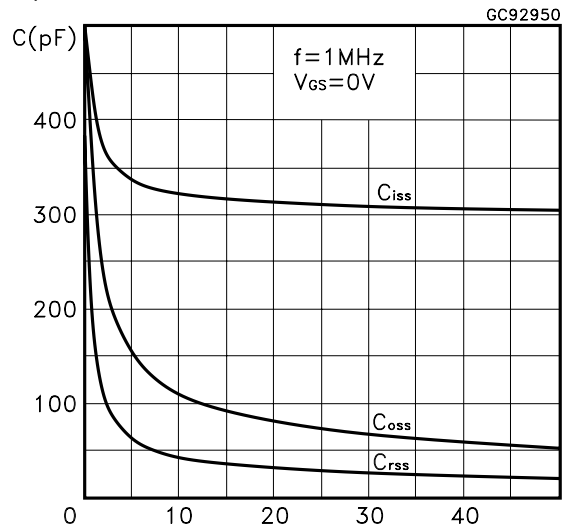
Static Drain-source On Resistance



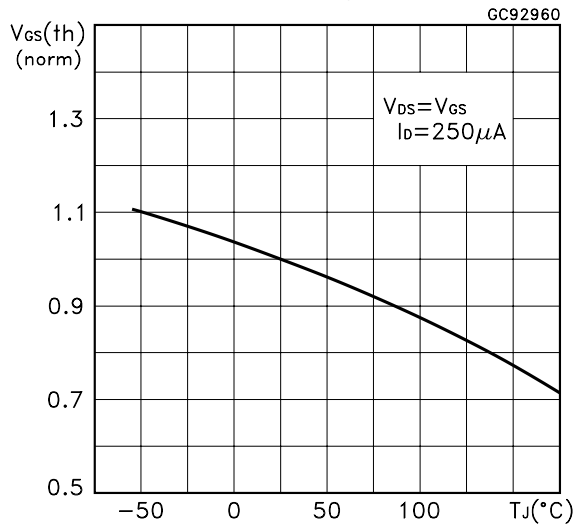
Gate Charge vs Gate-source Voltage



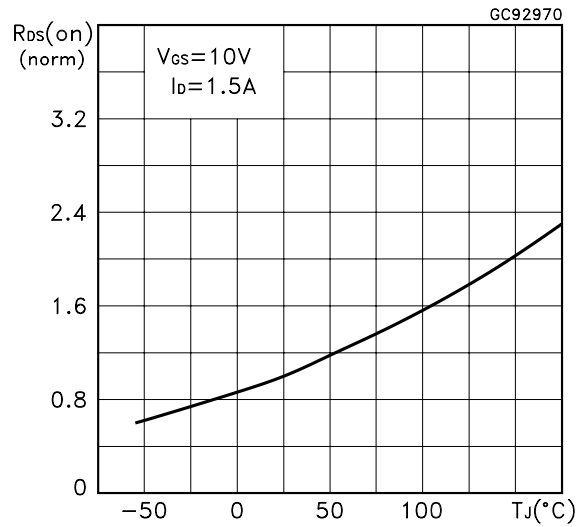
Capacitance Variations



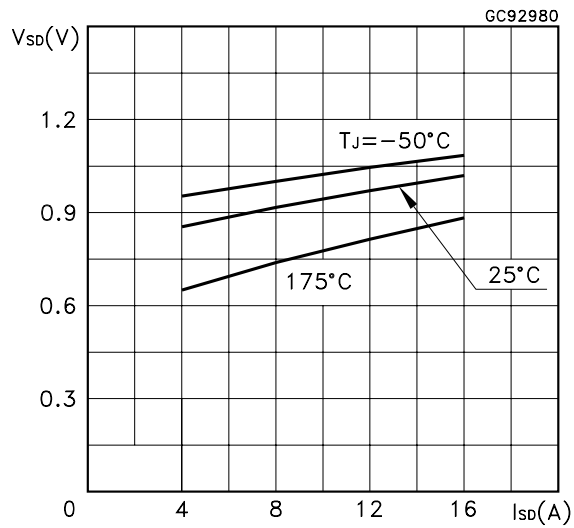
Normalized Gate Threshold Voltage vs Temperature



Normalized on Resistance vs Temperature



Source-drain Diode Forward Characteristics



Normalized Breakdown Voltage vs Temperature.

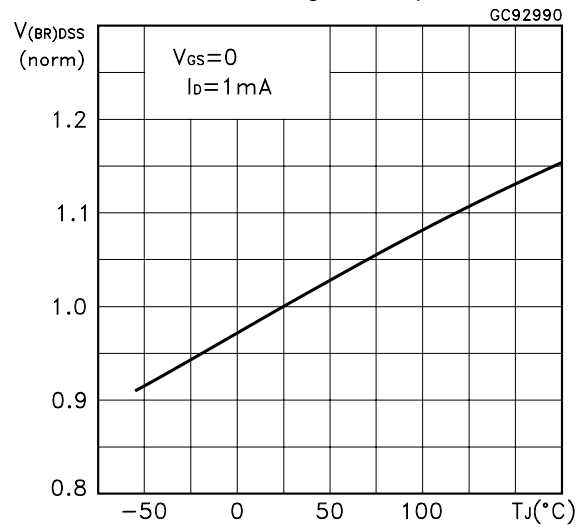


Fig. 1: Unclamped Inductive Load Test Circuit



Fig. 2: Unclamped Inductive Waveform



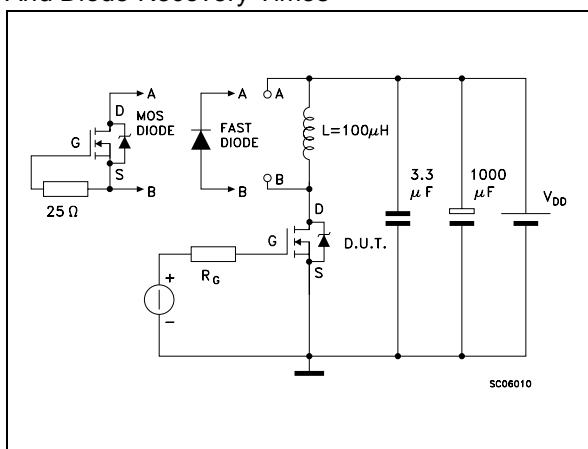
Fig. 3: Switching Times Test Circuits For Resistive Load



Fig. 4: Gate Charge test Circuit

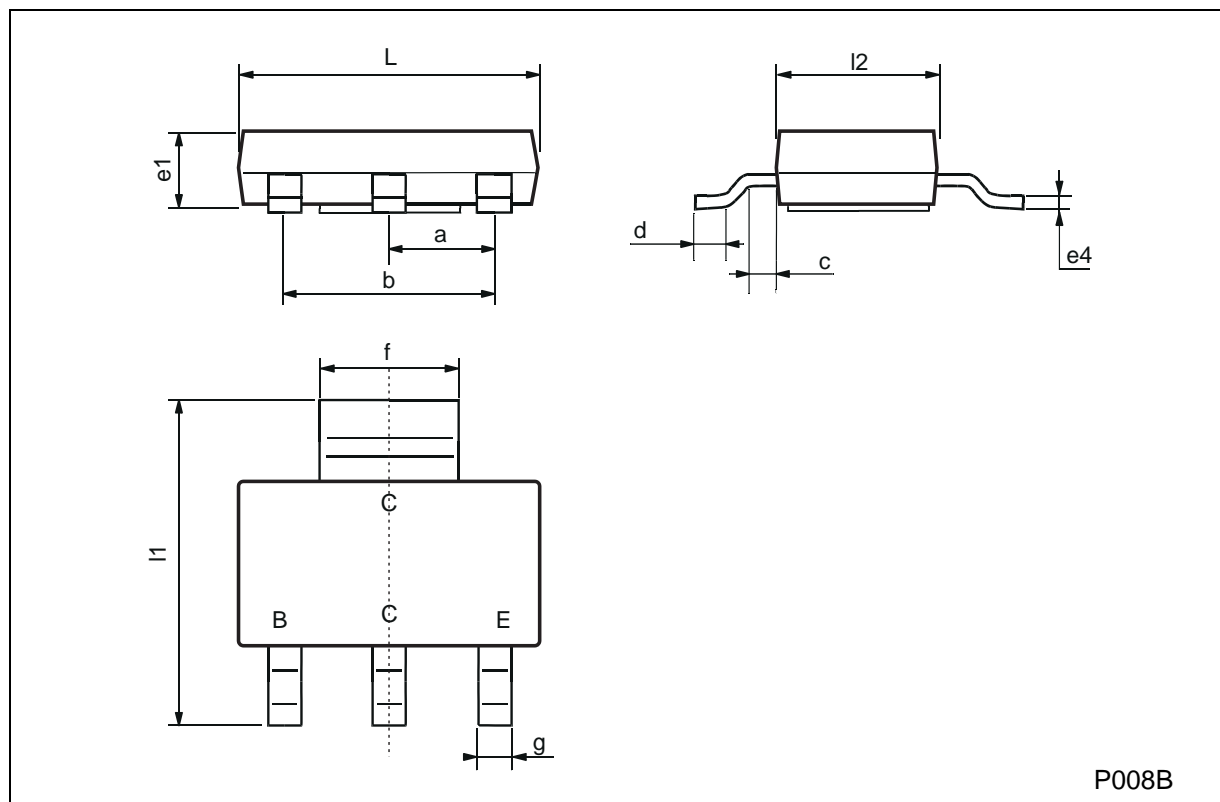


Fig. 5: Test Circuit For Inductive Load Switching And Diode Recovery Times



SOT-223 MECHANICAL DATA

DIM.	mm			mils		
	MIN.	TYP.	MAX.	MIN.	TYP.	MAX.
a	2.27	2.3	2.33	89.4	90.6	91.7
b	4.57	4.6	4.63	179.9	181.1	182.3
c	0.2	0.4	0.6	7.9	15.7	23.6
d	0.63	0.65	0.67	24.8	25.6	26.4
e1	1.5	1.6	1.7	59.1	63	66.9
e4			0.32			12.6
f	2.9	3	3.1	114.2	118.1	122.1
g	0.67	0.7	0.73	26.4	27.6	28.7
l1	6.7	7	7.3	263.8	275.6	287.4
l2	3.5	3.5	3.7	137.8	137.8	145.7
L	6.3	6.5	6.7	248	255.9	263.8



Information furnished is believed to be accurate and reliable. However, STMicroelectronics assumes no responsibility for the consequences of use of such information nor for any infringement of patents or other rights of third parties which may result from its use. No license is granted by implication or otherwise under any patent or patent rights of STMicroelectronics. Specifications mentioned in this publication are subject to change without notice. This publication supersedes and replaces all information previously supplied. STMicroelectronics products are not authorized for use as critical components in life support devices or systems without express written approval of STMicroelectronics.

The ST logo is registered trademark of STMicroelectronics
© 2001 STMicroelectronics - All Rights Reserved

All other names are the property of their respective owners.

STMicroelectronics GROUP OF COMPANIES
Australia - Brazil - China - Finland - France - Germany - Hong Kong - India - Italy - Japan - Malaysia - Malta - Morocco -
Singapore - Spain - Sweden - Switzerland - United Kingdom - U.S.A.

<http://www.st.com>