

FEATURES

- High Surge Capability

APPLICATIONS

- High Power Drives
- High Voltage Power Supplies
- DC Motor Control
- Welding
- Battery Chargers

KEY PARAMETERS

V_{DRM} 2000V

$I_{T(AV)}$ 75A

I_{TSM} 1400A

dV/dt^* 200V/ μ s

dI/dt 500A/ μ s

**Higher dV/dt selections available*

VOLTAGE RATINGS

| Type Number | Repetitive Peak Voltages V_{DRM} V_{RRM} V | Conditions |
|----------------|--|--|
| TK12 20 M or K | 2000 | $T_{vj} = 0^\circ$ to 125° C, $I_{DRM} = I_{RRM} = 100$ mA, $V_{DRM}, V_{RRM} t_p = 10$ ms, V_{DSM} & $V_{RSM} =$ V_{DRM} & $V_{RRM} + 100$ V Respectively |
| TK12 18 M or K | 1800 | |
| TK12 16 M or K | 1600 | |
| TK12 14 M or K | 1400 | |

Lower voltage grades available.

ORDERING INFORMATION

When ordering, select the required part number shown in the Voltage Ratings selection table, then:-

Add K to type number for 1/2" 20 UNF thread, e.g. **TK12 18K**.

or

Add M to type number for M12 thread, e.g. **TK12 14M**.

Note: Please use the complete part number when ordering and quote this number in any future correspondence relating to your order.

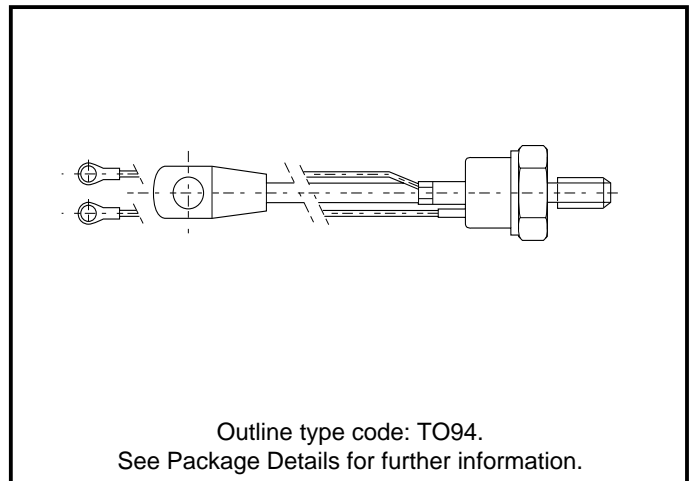

Fig. 1 Package outline

CURRENT RATINGS

$T_{case} = 60^{\circ}\text{C}$ unless stated otherwise.

| Symbol | Parameter | Conditions | Max. | Units |
|--------------|--------------------------------------|--------------------------|------|-------|
| $I_{T(AV)}$ | Mean on-state current | Half wave resistive load | 104 | A |
| $I_{T(RMS)}$ | RMS value | - | 163 | A |
| I_T | Continuous (direct) on-state current | - | 139 | A |

$T_{case} = 80^{\circ}\text{C}$ unless stated otherwise.

| Symbol | Parameter | Conditions | Max. | Units |
|--------------|--------------------------------------|--------------------------|------|-------|
| $I_{T(AV)}$ | Mean on-state current | Half wave resistive load | 75 | A |
| $I_{T(RMS)}$ | RMS value | - | 120 | A |
| I_T | Continuous (direct) on-state current | - | 100 | A |

SURGE RATINGS

| Symbol | Parameter | Conditions | Max. | Units |
|-----------|---|--|-------------------|----------------------|
| I_{TSM} | Surge (non-repetitive) on-state current | 10ms half sine; $T_{case} = 125^{\circ}\text{C}$ | 1.12 | kA |
| I^2t | I^2t for fusing | $V_R = 50\% V_{RRM}$ - 1/4 sine | 6.2×10^3 | A^2s |
| I_{TSM} | Surge (non-repetitive) on-state current | 10ms half sine; $T_{case} = 125^{\circ}\text{C}$ | 1.4 | kA |
| I^2t | I^2t for fusing | $V_R = 0$ | 9.8×10^3 | A^2s |

THERMAL AND MECHANICAL DATA

| Symbol | Parameter | Conditions | Min. | Max. | Units |
|---------------|---------------------------------------|---|------|------|-----------------------------|
| $R_{th(j-c)}$ | Thermal resistance - junction to case | dc | - | 0.24 | $^{\circ}\text{C}/\text{W}$ |
| $R_{th(c-h)}$ | Thermal resistance - case to heatsink | Mounting torque 15.0Nm with mounting compound | - | 0.08 | $^{\circ}\text{C}/\text{W}$ |
| T_{vj} | Virtual junction temperature | On-state (conducting) | - | 125 | $^{\circ}\text{C}$ |
| | | Reverse (blocking) | - | 125 | $^{\circ}\text{C}$ |
| T_{stg} | Storage temperature range | | -40 | 150 | $^{\circ}\text{C}$ |
| - | Mounting torque | | 12.0 | 15.0 | Nm |

DYNAMIC CHARACTERISTICS

| Symbol | Parameter | Conditions | Min. | Max. | Units | |
|-------------------|--|---|-----------------|------|------------|------------|
| V_{TM} | Maximum on-state voltage | At 150A peak, $T_{case} = 25^{\circ}C$ | - | 2.0 | V | |
| I_{RRM}/I_{DRM} | Peak reverse and off-state current | At V_{RRM}/V_{DRM} , $T_{case} = 125^{\circ}C$ | - | 10 | mA | |
| dV/dt | Maximum linear rate of rise of off-state voltage | To 60% V_{DRM} , $T_j = 125^{\circ}C$, Gate open circuit | - | 200 | V/ μ s | |
| dI/dt | Rate of rise of on-state current | Gate source 20V, 20 Ω $t_r \leq 0.5\mu$ s, $T_j = 125^{\circ}C$ | Repetitive 50Hz | - | 500 | A/ μ s |
| | | | Non-repetitive | - | 800 | A/ μ s |
| $V_{T(TO)}$ | Threshold voltage | At $T_{vj} = 125^{\circ}C$ | - | 1.4 | V | |
| r_T | On-state slope resistance | At $T_{vj} = 125^{\circ}C$ | - | 4.0 | m Ω | |
| t_{gd} | Delay time | $V_D = 300V$, $I_G = 1A$, $I_T = 50A$, dI/dt = 50A/ μ s, dI _G /dt = 1A/ μ s, $T_j = 25^{\circ}C$ | - | 1.5 | μ s | |
| I_L | Latching current | $T_j = 25^{\circ}C$, $V_D = 12V$ | - | - | mA | |
| I_H | Holding current | $T_j = 25^{\circ}C$, $V_D = 12V$, $I_{TM} = 1A$ | - | 50 | mA | |

GATE TRIGGER CHARACTERISTICS AND RATINGS

| Symbol | Parameter | Conditions | Typ. | Max. | Units |
|-------------|---------------------------|--|------|------|-------|
| V_{GT} | Gate trigger voltage | $V_{DRM} = 12V$, $T_{case} = 25^{\circ}C$, $R_L = 6\Omega$ | - | 3.0 | V |
| I_{GT} | Gate trigger current | $V_{DRM} = 12V$, $T_{case} = 25^{\circ}C$, $R_L = 6\Omega$ | - | 125 | mA |
| V_{GD} | Gate non-trigger voltage | At V_{DRM} , $T_{case} = 125^{\circ}C$, $R_L = 12\Omega$ | - | 0.2 | V |
| V_{FGM} | Peak forward gate voltage | Anode positive with respect to cathode | - | 3.0 | V |
| V_{FGN} | Peak forward gate voltage | Anode negative with respect to cathode | - | 0.25 | V |
| V_{RGM} | Peak reverse gate voltage | | - | 5 | V |
| I_{FGM} | Peak forward gate current | Anode positive with respect to cathode | - | 4 | A |
| P_{GM} | Peak gate power | - | - | 16 | W |
| $P_{G(AV)}$ | Mean gate power | | - | 3 | W |

CURVES

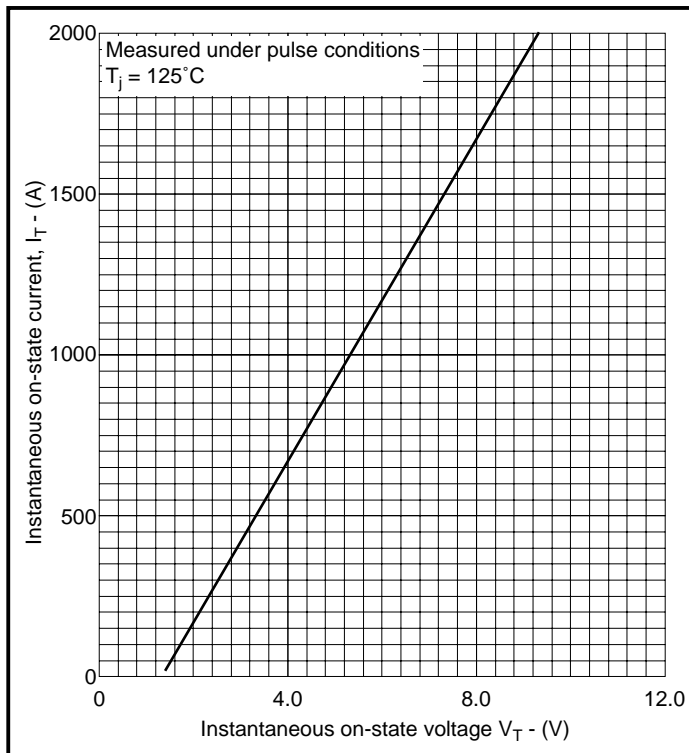
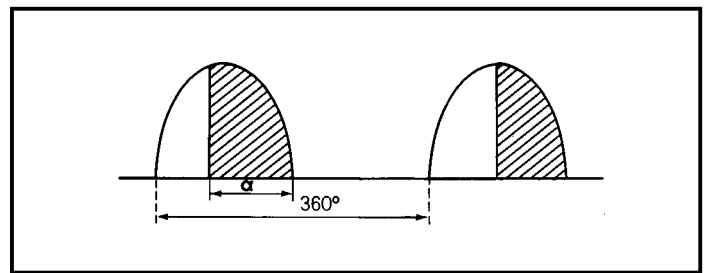

Fig.2 Maximum (limit) on-state characteristics

SINUSOIDAL CURRENT WAVEFORM



RECTANGULAR CURRENT WAVEFORM

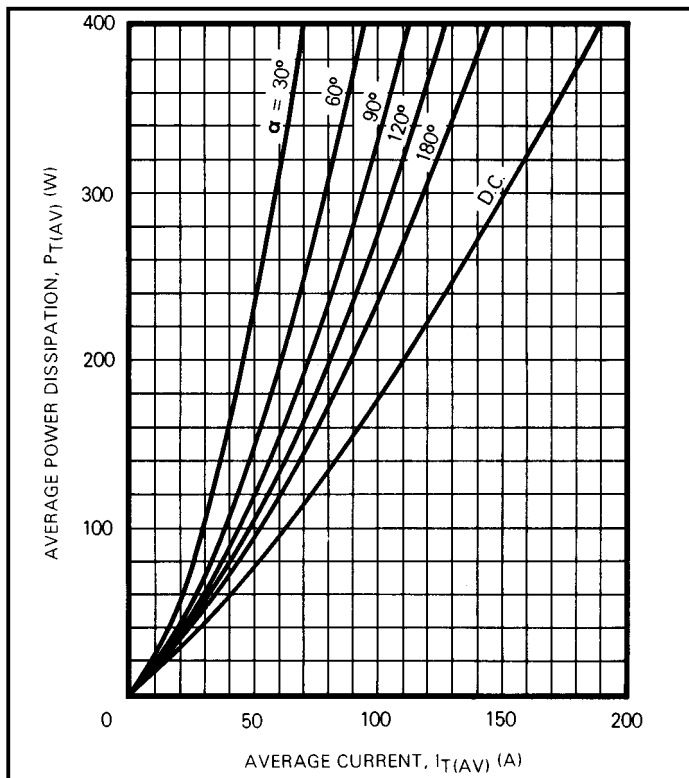
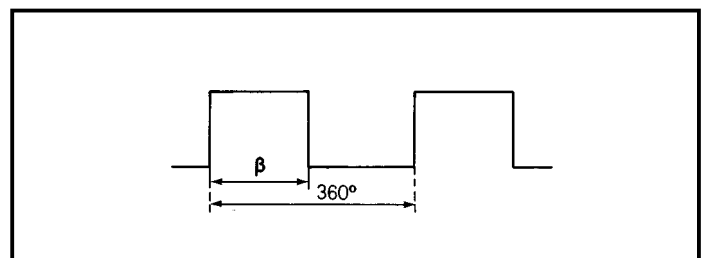

Fig.3 Maximum on-state power dissipation for sinusoidal current waveform

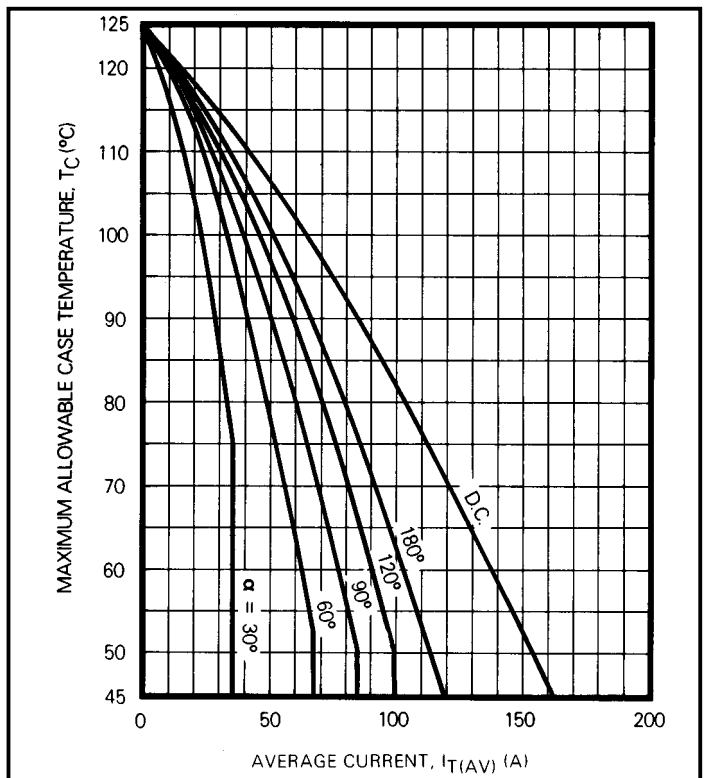

Fig.4 Maximum allowable case temperature for sinusoidal current waveform

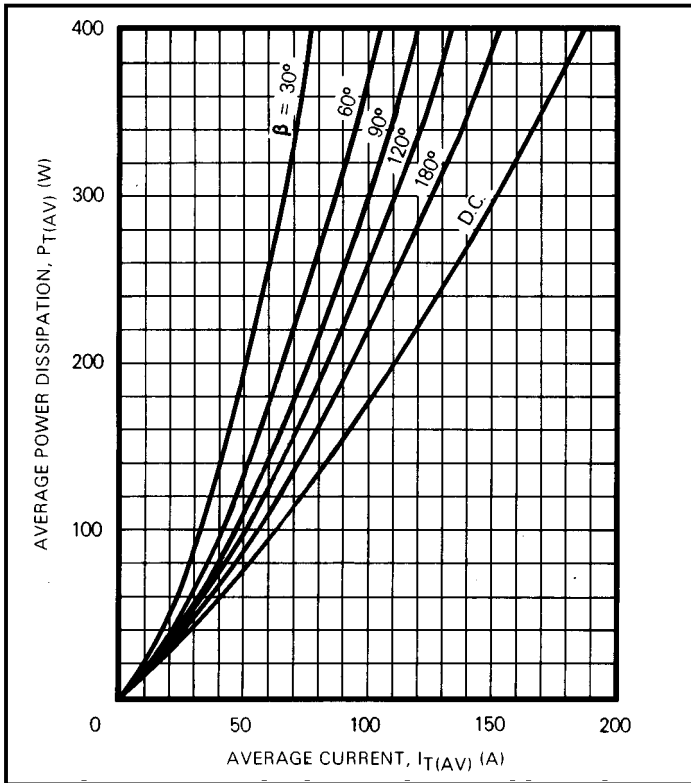

Fig.5 Maximum on-state power dissipation for rectangular current waveform

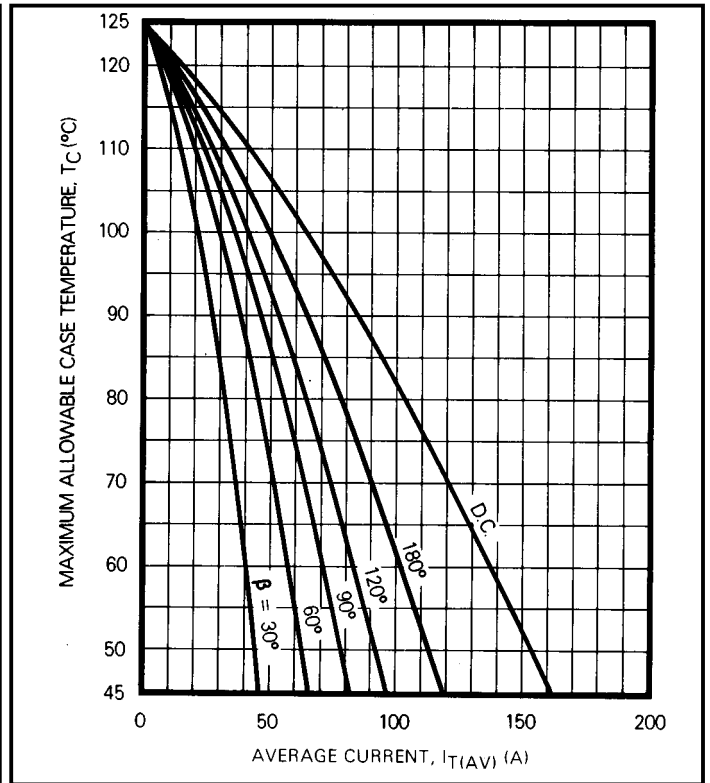

Fig.6 Maximum allowable case temperature for rectangular current waveform

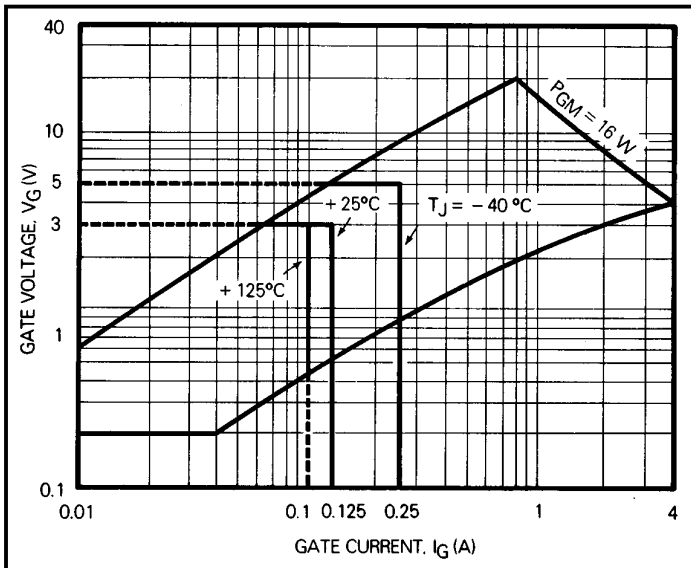

Fig.7 Gate trigger characteristics

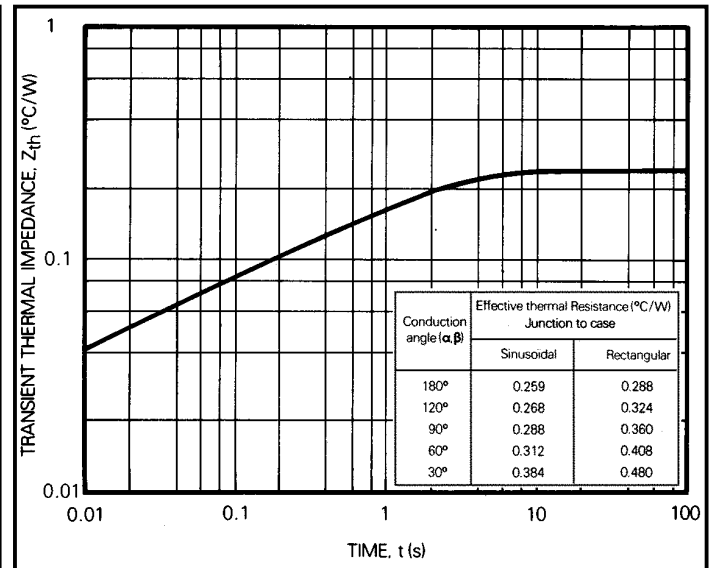

Fig.8 Transient thermal impedance - junction to case

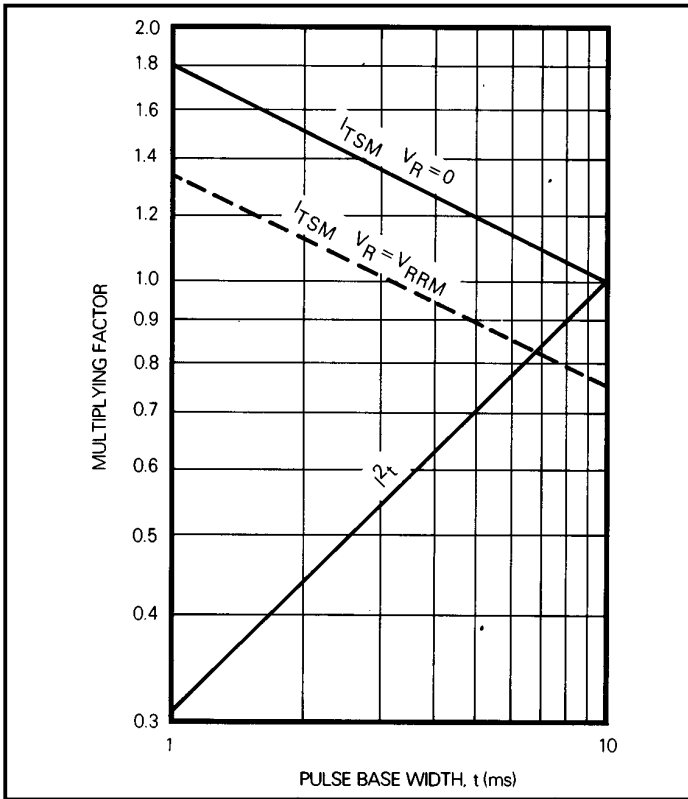

Fig.9 Multiplying factor for non-repetitive sub-cycle surge on-state current and I^2t rating

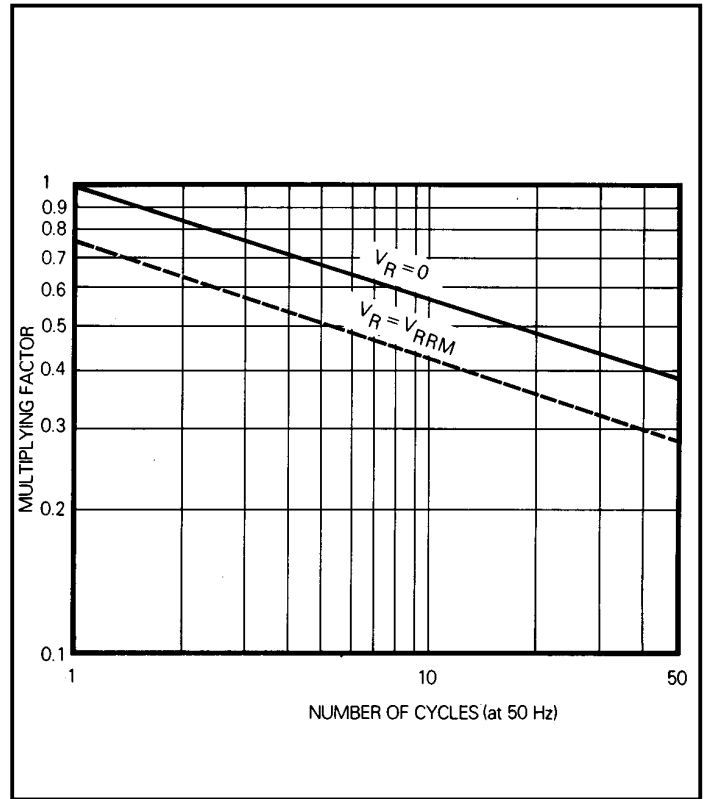
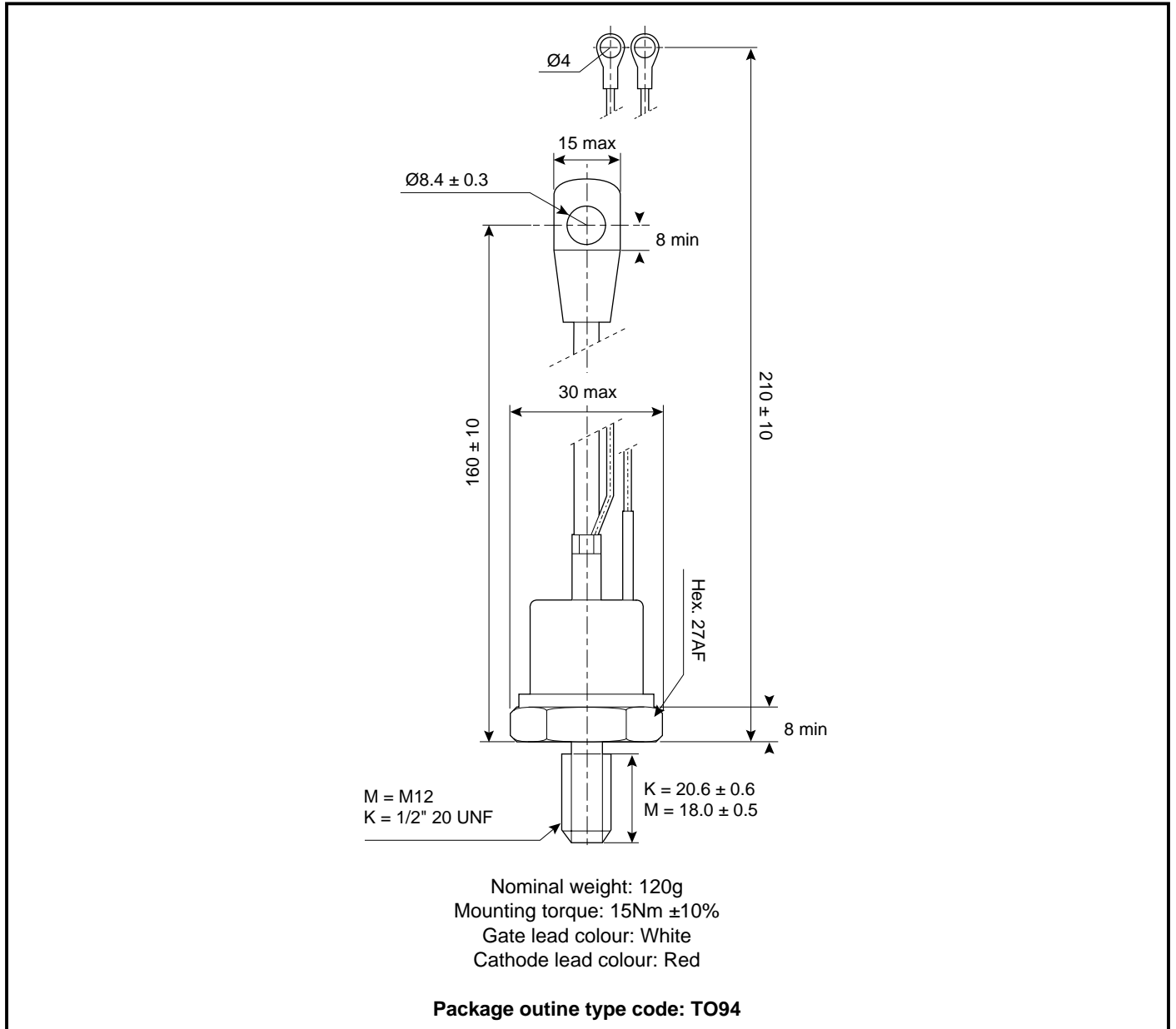

Fig.10 Multiplying factor for non-repetitive surge on-state current

PACKAGE DETAILS

For further package information, please contact your nearest Customer Service Centre. All dimensions in mm, unless stated otherwise. DO NOT SCALE.



POWER ASSEMBLY CAPABILITY

The Power Assembly group was set up to provide a support service for those customers requiring more than the basic semiconductor, and has developed a flexible range of heatsink and clamping systems in line with advances in device voltages and current capability of our semiconductors.

We offer an extensive range of air and liquid cooled assemblies covering the full range of circuit designs in general use today. The Assembly group continues to offer high quality engineering support dedicated to designing new units to satisfy the growing needs of our customers.

Using the latest CAD methods our team of design and applications engineers aim to provide the Power Assembly Complete Solution (PACs).

DEVICE CLAMPS

Disc devices require the correct clamping force to ensure their safe operation. The PACS range includes a varied selection of pre-loaded clamps to suit all of our manufactured devices. Types available include cube clamps for single side cooling of 'T' 23mm and 'E' 30mm discs, and bar clamps right up to 83kN for our 'Z' 100mm thyristors and diodes.

Clamps are available for single or double side cooling, with high insulation versions for high voltage assemblies.

Please refer to our application note on device clamping, AN4839

HEATSINKS

The Power Assembly group has its own proprietary range of extruded aluminium heatsinks. They have been designed to optimise the performance of Dynex semiconductors. Data with respect to air natural, forced air and liquid cooling (with flow rates) is available on request.

For further information on device clamps, heatsinks and assemblies, please contact your nearest sales representative or customer service office.



<http://www.dynexsemi.com>

e-mail: power_solutions@dynexsemi.com

HEADQUARTERS OPERATIONS
DYNEX SEMICONDUCTOR LTD
 Doddington Road, Lincoln.
 Lincolnshire. LN6 3LF. United Kingdom.
 Tel: 00-44-(0)1522-500500
 Fax: 00-44-(0)1522-500550

DYNEX POWER INC.
 99 Bank Street, Suite 410,
 Ottawa, Ontario, Canada, K1P 6B9
 Tel: 613.723.7035
 Fax: 613.723.1518
 Toll Free: 1.888.33.DYNEX (39639)

CUSTOMER SERVICE CENTRES
Mainland Europe Tel: +33 (0)1 58 04 91 00. Fax: +33 (0)1 46 38 51 33
North America Tel: (613) 723-7035. Fax: (613) 723-1518.
UK, Scandinavia & Rest Of World Tel: +44 (0)1522 500500. Fax: +44 (0)1522 500020

SALES OFFICES
Mainland Europe Tel: +33 (0)1 58 04 91 00. Fax: +33 (0)1 46 38 51 33
North America Tel: (613) 723-7035. Fax: (613) 723-1518. Toll Free: 1.888.33.DYNEX (39639) /
 Tel: (949) 733-3005. Fax: (949) 733-2986.
UK, Scandinavia & Rest Of World Tel: +44 (0)1522 500500. Fax: +44 (0)1522 500020

These offices are supported by Representatives and Distributors in many countries world-wide.
 © Dynex Semiconductor 2001 Publication No. DS4252-5 Issue No. 5.0 July 2001
 TECHNICAL DOCUMENTATION – NOT FOR RESALE. PRINTED IN UNITED KINGDOM

Datasheet Annotations:

Dynex Semiconductor annotate datasheets in the top right hand corner of the front page, to indicate product status. The annotations are as follows:-

Target Information: This is the most tentative form of information and represents a very preliminary specification. No actual design work on the product has been started.

Preliminary Information: The product is in design and development. The datasheet represents the product as it is understood but details may change.

Advance Information: The product design is complete and final characterisation for volume production is well in hand.

No Annotation: The product parameters are fixed and the product is available to datasheet specification.

This publication is issued to provide information only which (unless agreed by the Company in writing) may not be used, applied or reproduced for any purpose nor form part of any order or contract nor to be regarded as a representation relating to the products or services concerned. No warranty or guarantee express or implied is made regarding the capability, performance or suitability of any product or service. The Company reserves the right to alter without prior notice the specification, design or price of any product or service. Information concerning possible methods of use is provided as a guide only and does not constitute any guarantee that such methods of use will be satisfactory in a specific piece of equipment. It is the user's responsibility to fully determine the performance and suitability of any equipment using such information and to ensure that any publication or data used is up to date and has not been superseded. These products are not suitable for use in any medical products whose failure to perform may result in significant injury or death to the user. All products and materials are sold and services provided subject to the Company's conditions of sale, which are available on request.

All brand names and product names used in this publication are trademarks, registered trademarks or trade names of their respective owners.