

TOSHIBA PHOTOINTERRUPTER INFRARED LED + PHOTO IC

TLP1002A, TLP1003A

HOME ELECTRIC EQUIPMENT SUCH AT VCR, CD PLAYER

OA EQUIPMENT SUCH AS COPYING MACHINE, PRINTER, FACSIMILE, ETC.

AUTOMATIC SERVICE EQUIPMENT SUCH AS VENDING MACHINE, TICKETING MACHINE, ETC.

VARIOUS POSITION DETECTION

TLP1002A and TLP1003A are digital output photo-interrupters combining GaAs infrared LED with high sensitive and high gain Si photo IC. Directly connectable to TTL, LSTTL and CMOS.

- One side mounting type
- Gap : 5mm
- Resolution : Slit width 1mm
- Digital output (with a pull-up resistor)
 - TLP1002A : Low level output at shielding
 - TLP1003A : High level output at shielding
- Built-in Schmitt trigger circuit
- Threshold input current : 3mA (Max.) at Ta=25°C
- Operating supply voltage : V_{CC}=4.5~17V
- Fast response speed
- Detector side is of visible light cut type.

Unit in mm

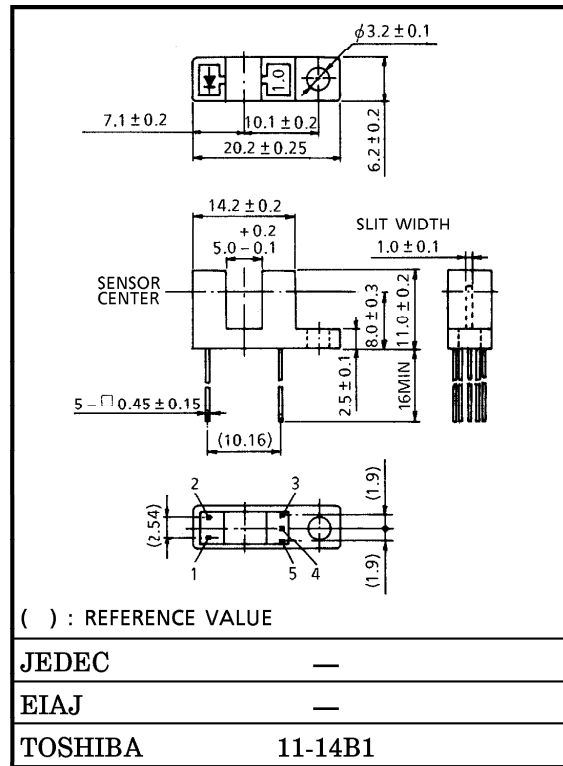

Weight : 0.88g (Typ.)

PIN CONNECTION

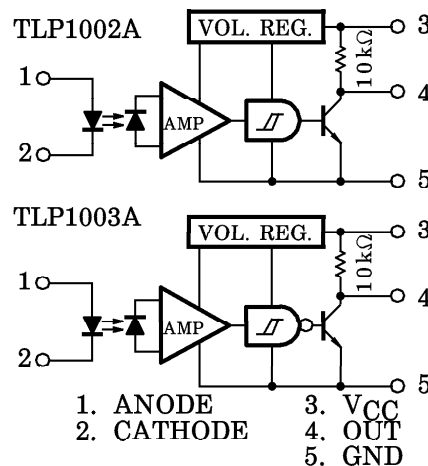

961001EBC2

● TOSHIBA is continually working to improve the quality and the reliability of its products. Nevertheless, semiconductor devices in general can malfunction or fail due to their inherent electrical sensitivity and vulnerability to physical stress. It is the responsibility of the buyer, when utilizing TOSHIBA products, to observe standards of safety, and to avoid situations in which a malfunction or failure of a TOSHIBA product could cause loss of human life, bodily injury or damage to property. In developing your designs, please ensure that TOSHIBA products are used within specified operating ranges as set forth in the most recent products specifications. Also, please keep in mind the precautions and conditions set forth in the TOSHIBA Semiconductor Reliability Handbook.

● Gallium arsenide (GaAs) is a substance used in the products described in this document. GaAs dust and fumes are toxic. Do not break, cut or pulverize the product, or use chemicals to dissolve them. When disposing of the products, follow the appropriate regulations. Do not dispose of the products with other industrial waste or with domestic garbage.

● The products described in this document are subject to foreign exchange and foreign trade control laws.

● The information contained herein is presented only as a guide for the applications of our products. No responsibility is assumed by TOSHIBA CORPORATION for any infringements of intellectual property or other rights of the third parties which may result from its use. No license is granted by implication or otherwise under any intellectual property or other rights of TOSHIBA CORPORATION or others.

● The information contained herein is subject to change without notice.

MAXIMUM RATINGS (Ta = 25°C)

CHARACTERISTIC		SYMBOL	RATING	UNIT
LED	Forward Current	I_F	50	mA
	Forward Current Derating (Ta > 25°C)	$\Delta I_F / ^\circ C$	-0.33	mA / °C
	Reverse Voltage	V_R	5	V
DETECTOR	Supply Voltage	V_{CC}	17	V
	Output Current	I_O	50	mA
	Power Dissipation	P_O	250	mW
	Power Dissipation Derating (Ta > 25°C)	$\Delta P_O / ^\circ C$	-3.33	mW / °C
Operating Temperature Range		T_{opr}	-25~85	°C
Storage Temperature Range		T_{stg}	-40~100	°C
Soldering Temperature (5s)		T_{sol}	260	°C

RECOMMENDED OPERATING CONDITION

CHARACTERISTIC	SYMBOL	MIN.	TYP.	MAX.	UNIT
LED Forward Current	I_F	10.6*	—	20	mA
Supply Voltage	V_{CC}	4.5	5.0	17	V
Low Level Output Current	I_{OL}	—	—	16	mA
Operating Temperature	T_{opr}	-25	—	85	°C

* 10.6mA is a value when 50% LED deterioration is taken into consideration. Initial threshold input current shall be 5.3mA MAX.

OPTO-ELECTRICAL CHARACTERISTICS (Unless otherwise specified, Ta = -25~85°C, VCC = 5V ± 10%)

CHARACTERISTIC		SYMBOL	TEST CONDITION	MIN.	TYP.	MAX.	UNIT	
LED	Forward Voltage	V _F	I _F = 10mA, Ta = 25°C	1.00	1.15	1.30	V	
	Reverse Voltage	I _R	V _R = 5V, Ta = 25°C	—	—	10	μA	
	Peak Emission Wavelength	λ _P	I _F = 15mA, Ta = 25°C	—	940	—	nm	
DETECTOR	Supply Voltage	V _{CC}	—	4.5	—	17	V	
	Low Level Supply Current	I _{CCL}	I _F = *1	—	—	6.0	mA	
			I _F = *1, V _{CC} = 17V	—	—	7.5		
	High Level Supply Current	I _{CCH}	I _F = *2	—	—	3.0	mA	
			I _F = *2, V _{CC} = 17V	—	—	3.2		
	Low Level Output Voltage	V _{OL}	I _{OL} = 16mA, I _F = *1 Ta = 25°C	—	0.07	0.3	V	
			I _{OL} = 16mA, I _F = *1 V _{CC} = 17V	—	—	0.4		
High Level Output Voltage	V _{OH}	I _F = *2	0.9V _{CC}	—	—	V		
Peak Sensitivity Wavelength	λ _P	Ta = 25°C	—	900	—	nm		
COUPLED	L→H Threshold Input Current	I _{FLH}	Ta = 25°C	TLP1002A	—	—	3.0	mA
			V _{CC} = 17V		—	—	5.3	
	H→L Threshold Input Current	I _{FHL}	Ta = 25°C	TLP1003A	—	—	3.0	mA
			V _{CC} = 17V		—	—	5.3	
	Hysteresis Ratio	I _{FHL} / I _{FLH}	—	TLP1002A	—	0.67	—	—
				TLP1003A	—	1.5	—	
	Propagation Delay Time (L→H)	t _{pLH}	V _{CC} = 5V I _F = 15mA R _L = 280Ω Ta = 25°C (Note)	TLP1002A	—	3	—	μs
				TLP1003A	—	6	—	
Propagation Delay Time (H→L)	t _{pHL}	TLP1002A		—	6	—		
		TLP1003A		—	3	—		
Rise Time	t _r	—		—	0.1	—		
Fall Time	t _f	—		—	0.05	—		

*1. TLP1002A = 0, TLP1003A = 15mA

*2. TLP1002A = 15mA, TLP1003A = 0

NOTE : SWITCHING TIME TEST CIRCUIT

TLP1002A

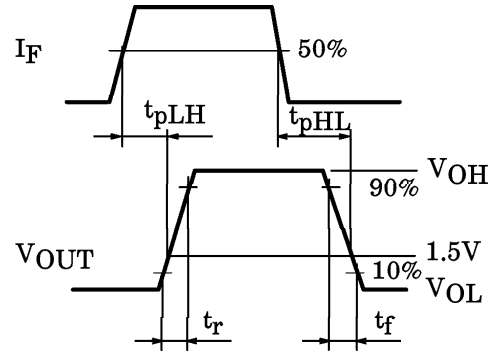
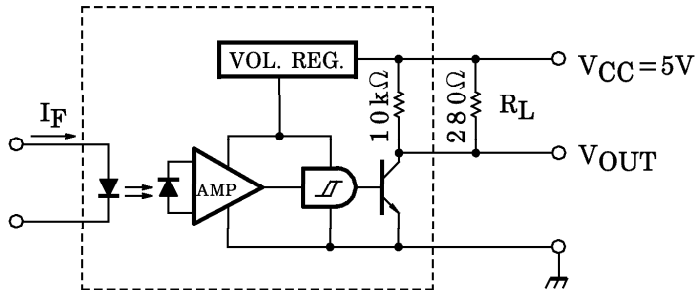

TLP1003A

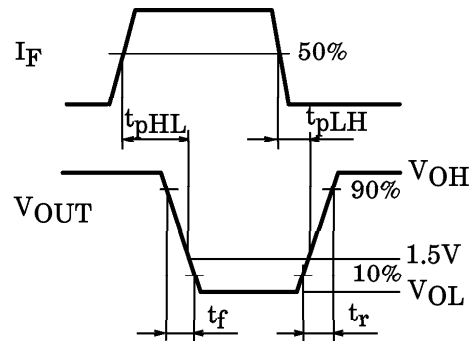
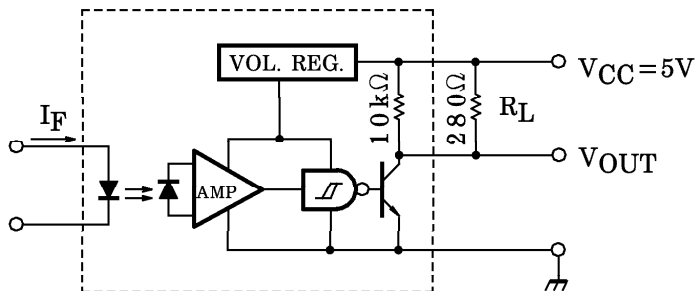

PRODUCT INDICATION

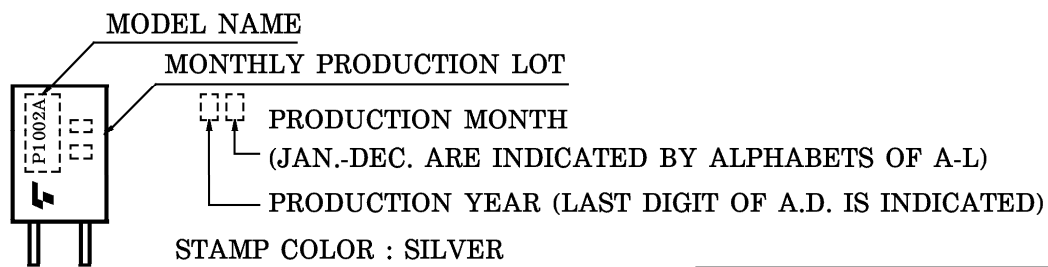

ABBREVIATION	TYPE
P1002A	TLP1002A
P1003A	TLP1003A

PRECAUTION

Please be careful of the followings.

1. Soldering should be performed after lead forming.
2. If chemicals are used for cleaning, the soldered surface only shall be cleaned with chemicals avoiding the whole cleaning of the package.
3. The container is made of polycarbonate. Polycarbonate is usually stable with acid, alcohol, and aliphatic hydrocarbons however, with peroxochemicals (such as benzene, toluene, and acetone), alkali, aromatic hydrocarbons, or chloric hydrocarbons, polycarbonate becomes cracked, swollen, or melted. Please take care when choosing a packaging material by referencing the table below.

<Chemicals to avoid with polycarbonate>

	PHENOMENON	CHEMICALS
A	Little deterioration but staining	<ul style="list-style-type: none"> • nitric acid (low concentration), hydrogen peroxide, chlorine
B	Cracked, crazed, or swollen	<ul style="list-style-type: none"> • acetic acid (70% or more) • gasoline • methyl ethyl ketone, ethyl acetate, butyl acetate • ethyl methacrylate, ethyl ether, MEK • acetone, m-amino alcohol, carbon tetrachloride • carbon disulfide, trichloroethylene, cresol • thinners, oil of turpentine • triethanolamine, TCP, TBP
C	Melted { } : Used as solvent.	<ul style="list-style-type: none"> • concentrated sulfuric acid • benzene • styrene, acrylonitrile, vinyl acetate • ethylenediamine, diethylenediamine • {chloroform, methyl chloride, tetrachloromethane, dioxane, 1, 2-dichloroethane }
D	Decomposed	<ul style="list-style-type: none"> • ammonia water • other alkali

4. During 100 μ s after turning on V_{CC}, output voltage changes for stabilizing the inner circuit.
5. Supply the by-pass condenser up to 0.01 μ F between V_{CC} and GND near device to stabilize the power supply line.
6. Screw shall be tightened to clamping torque of 0.59N·m.

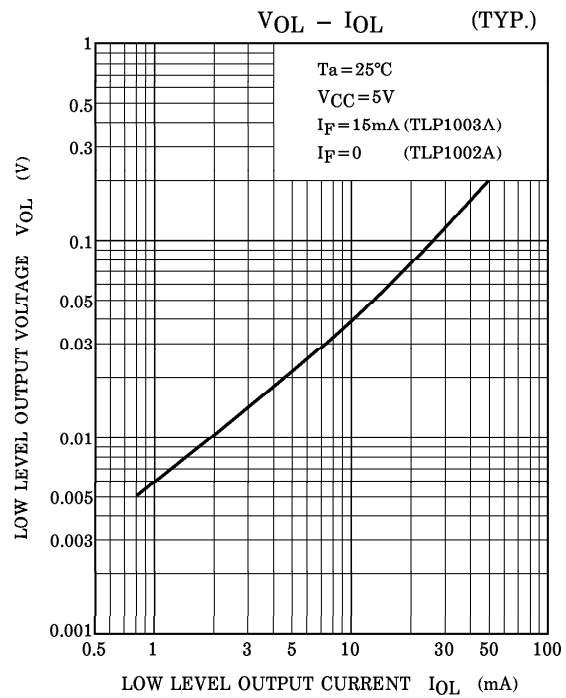
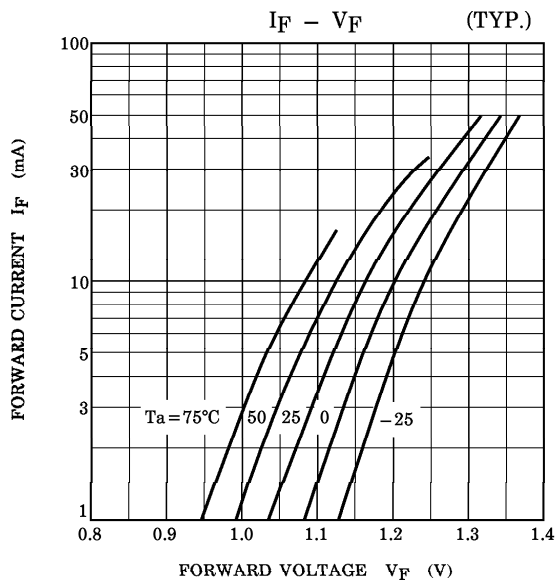
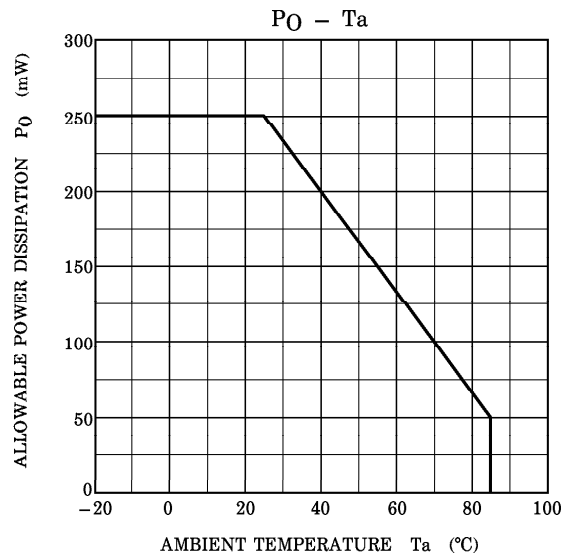
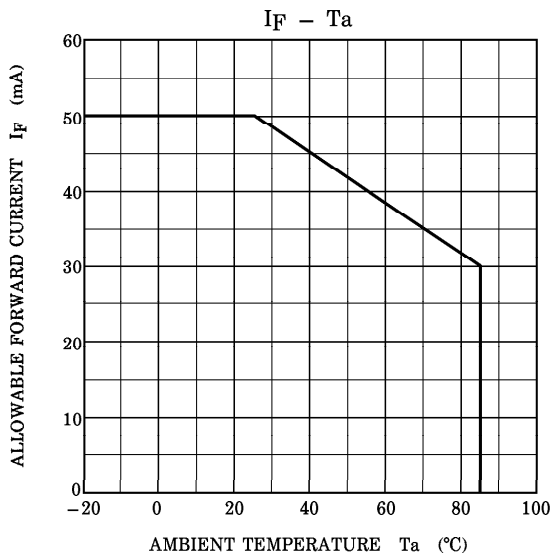

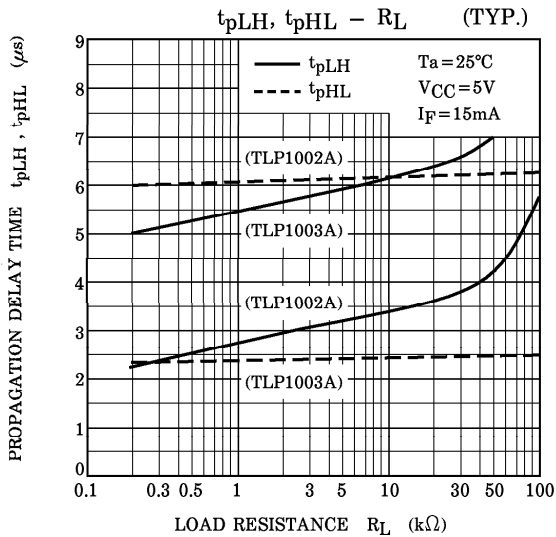
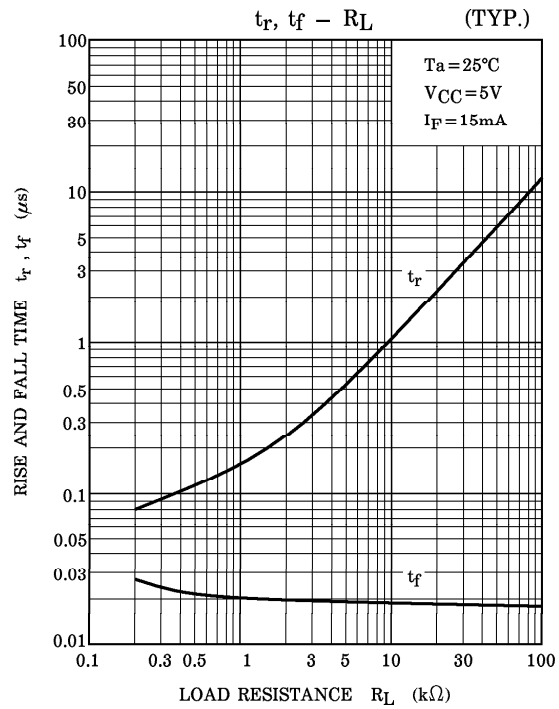
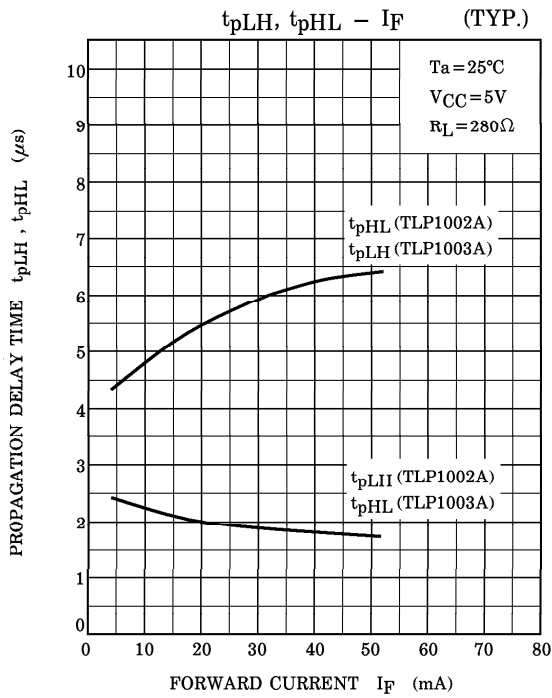

TLP1002A DETECTING POSITION CHARACTERISTICS (1) (TYP.)

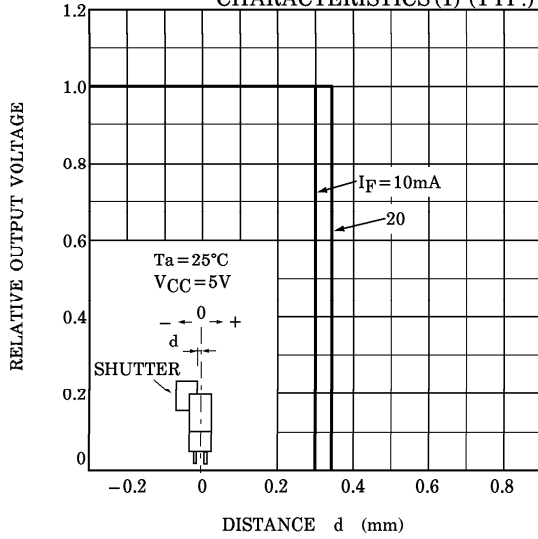

TLP1002A DETECTING POSITION CHARACTERISTICS (2) (TYP.)

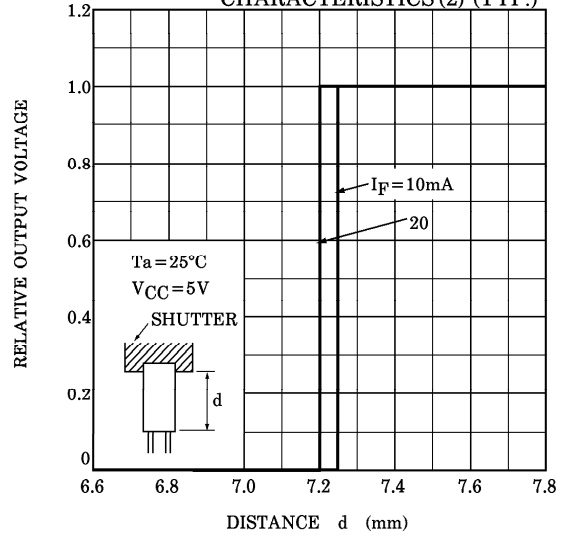

TLP1003A DETECTING POSITION CHARACTERISTICS (1) (TYP.)

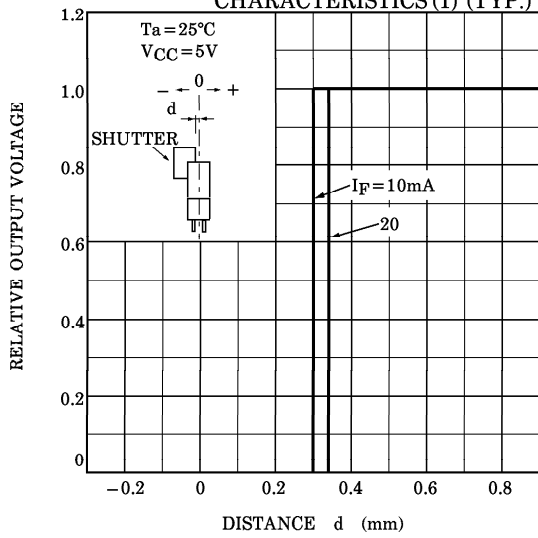

TLP1003A DETECTING POSITION CHARACTERISTICS (2) (TYP.)

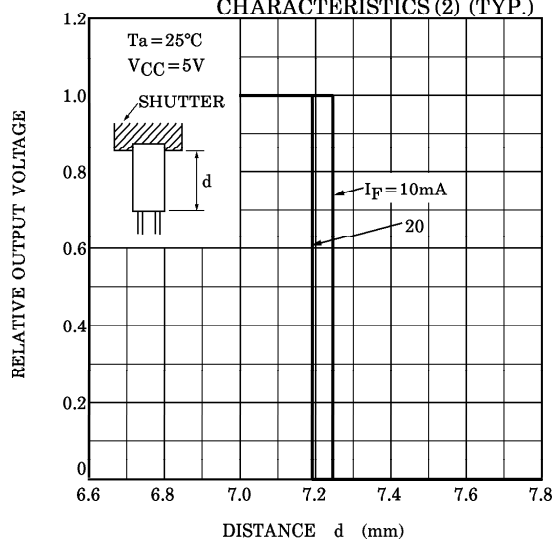

POSITIONING OF SHUTTER AND DEVICE

To operate correctly, make sure that the shutter and the device are positioned as shown in the figure below.

The slit pitch of the shutter must be set wider than the slit width of the device.
Determine the width taking the switching time into consideration.

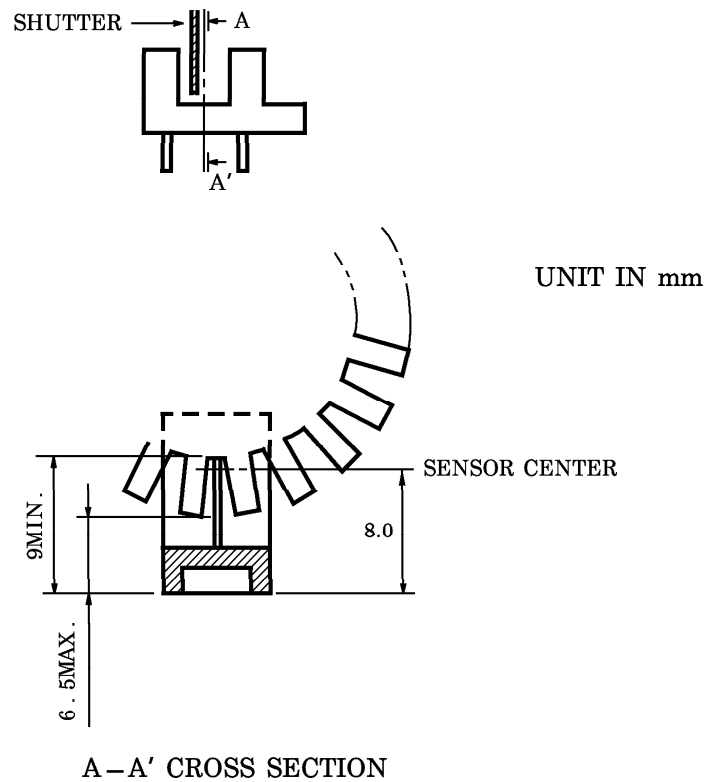

This datasheet has been download from:

www.datasheetcatalog.com

Datasheets for electronics components.