

Features

3.2 (L) x 2.8 (W) x 1.9 (H) mm Size
 Flat-top Type
 InGaAlP Technology
 Low Drive Current, High Intensity Light Emission
 Standard embossed taping : T11 (2000 pcs/reel) 8 mm tape reel

Applications

Automotive Use
 Message Signboard
 Backlight

Series Line-Up

Part Number	Color	Material
TLGE1100	Ultra Bright Yellow Green	InGaAlP
TLOE1100	Ultra Bright Orange	InGaAlP
TLPGE1100	Ultra Pure Green	InGaAlP
TLRE1100	Ultra Bright Red	InGaAlP
TLSE1100	Ultra Bright High Efficiency Red	InGaAlP
TLYE1100	Ultra Bright Yellow	InGaAlP

Maximum Ratings (Ta=25°C)

Part Number	Forward Current I _F	Reverse Voltage V _R	Power Dissipation P _D	Operating Temperature T _{opr}	Storage Temperature T _{stg}
TLGE1100	50	4	120.00	-40 ~ 100	-40 ~ 100
TLOE1100	50	4	120.00	-40 ~ 100	-40 ~ 100
TLPGE1100	50	4	120.00	-40 ~ 100	-40 ~ 100
TLRE1100	50	4	120.00	-40 ~ 100	-40 ~ 100
TLSE1100	50	4	120.00	-40 ~ 100	-40 ~ 100
TLYE1100	50	4	120.00	-40 ~ 100	-40 ~ 100
Unit	mA	V	mW	°C	°C

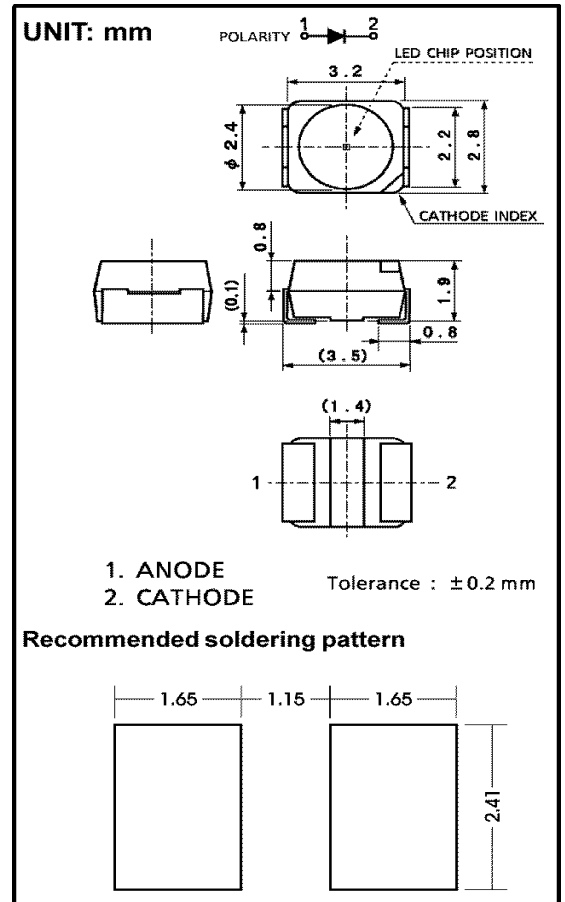

Electrical and Optical Characteristics (Ta=25°C)

Part Number	PWL nm λ_P	Material	View Angle $2\theta_{1/2}$	Luminous Intensity I_v				Forward Voltage V_F				Rev Current I_R		
				min.	typ.	max.	IF@	min.	typ.	max.	IF@	max.	VR@	
TLGE1100	574	InGaAIP	120°	47.60	100.00	–	20mA	–	2.00	2.40	20mA	50	4V	
TLOE1100	612	InGaAIP	120°	47.60	180.00	–	20mA	–	2.00	2.40	20mA	50	4V	
TLPGE1100	562	InGaAIP	120°	8.50	25.00	–	20mA	–	2.10	2.40	20mA	50	4V	
TLRE1100	644	InGaAIP	120°	47.60	100.00	–	20mA	–	1.90	2.40	20mA	50	4V	
TLSE1100	623	InGaAIP	120°	47.60	180.00	–	20mA	–	1.90	2.40	20mA	50	4V	
TLYE1100	590	InGaAIP	120°	47.60	150.00	–	20mA	–	2.00	2.40	20mA	50	4V	
–	nm	–	deg	mcd				–	V			–	μ A	–

NOTICE:

- TOSHIBA is continually working to improve the quality and reliability of its products. Nevertheless, semiconductor devices in general can malfunction or fail due to their inherent electrical sensitivity and vulnerability to physical stress. It is the responsibility of the buyer, when utilizing TOSHIBA products, to comply with the standards of safety in making a safe design for the entire system, and to avoid situations in which a malfunction or failure of such TOSHIBA products could cause loss of human life, bodily injury or damage to property.
- In developing your designs, please ensure that TOSHIBA products are used within specified operating ranges as set forth in the most recent TOSHIBA products specifications. Also, please keep in mind the precautions and conditions set forth in the "Handling Guide for Semiconductor Devices," or "TOSHIBA Semiconductor Reliability Handbook" etc..
- The TOSHIBA products listed in this document are intended for usage in general electronics applications (computer, personal equipment, office equipment, measuring equipment, industrial robotics, domestic appliances, etc.). These TOSHIBA products are neither intended nor warranted for usage in equipment that requires extraordinarily high quality and/or reliability or a malfunction or failure of which may cause loss of human life or bodily injury ("Unintended Usage"). Unintended Usage include atomic energy control instruments, airplane or spaceship instruments, transportation instruments, traffic signal instruments, combustion control instruments, medical instruments, all types of safety devices, etc.. Unintended Usage of TOSHIBA products listed in this document shall be made at the customer's own risk.
- Gallium arsenide (GaAs) is a substance used in the products described in this document. GaAs dust and fumes are toxic. Do not break, cut or pulverize the product, or use chemicals to dissolve them. When disposing of the products, follow the appropriate regulations. Do not dispose of the products with other industrial waste or with domestic garbage.
- The information contained herein is presented only as a guide for the applications of our products. No responsibility is assumed by TOSHIBA CORPORATION for any infringements of intellectual property or other rights of the third parties which may result from its use. No license is granted by implication or otherwise under any intellectual property or other rights of TOSHIBA CORPORATION or others.
- The information contained herein is subject to change without notice.

Company Headquarters
 3 Norway Lane North
 Latham, New York 12110
 Toll Free: 800.984.5337
 Fax: 518.785.4725



Web: www.marktechopt.com | Email: info@marktechopt.com

West Coast Sales Office
 950 South Coast Drive, Suite 265
 Costa Mesa, California 92626
 Toll Free: 800.984.5337
 Fax: 714.850.9314

TLGE1100 Graphs

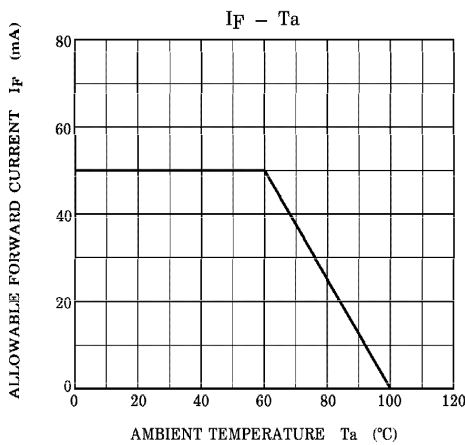
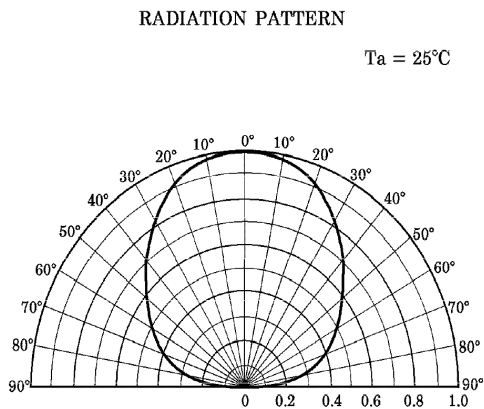
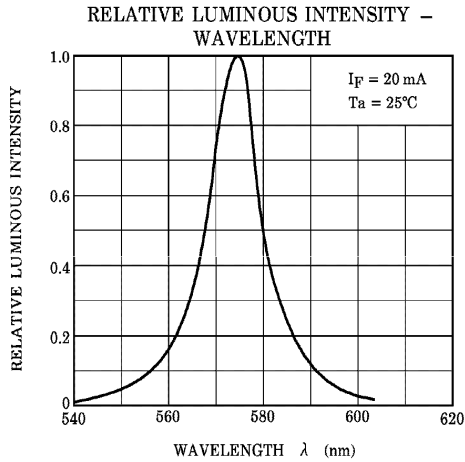
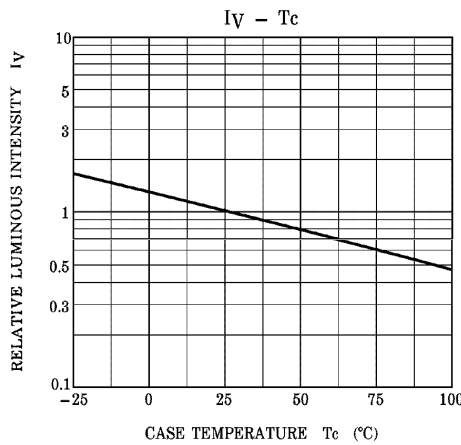
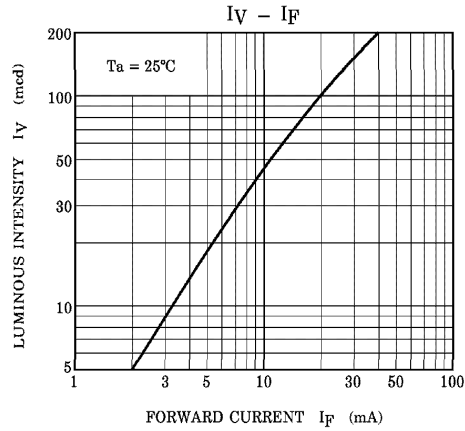
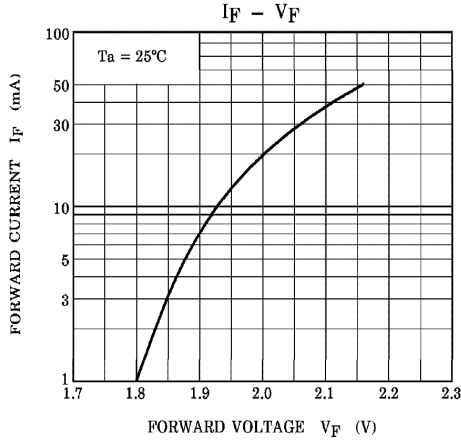

TLOE1100 Graphs

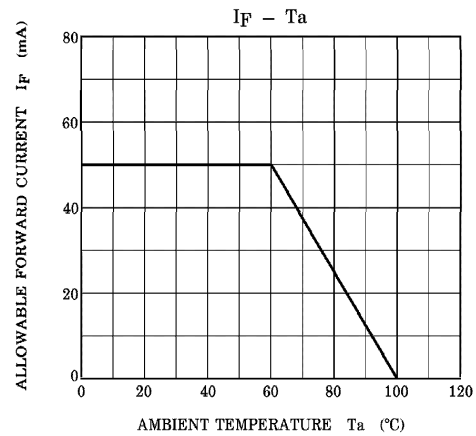
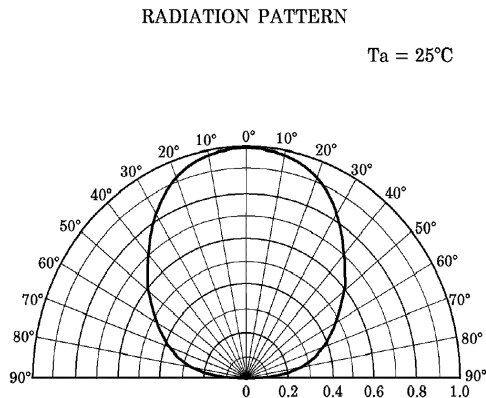
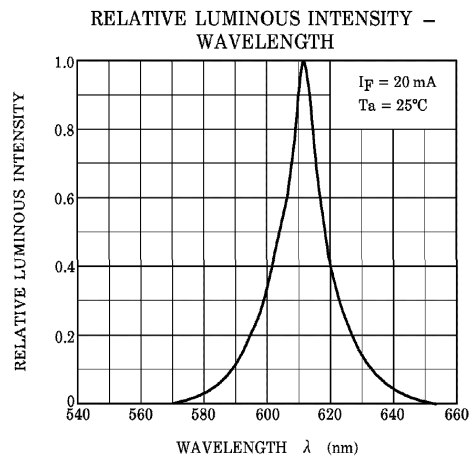
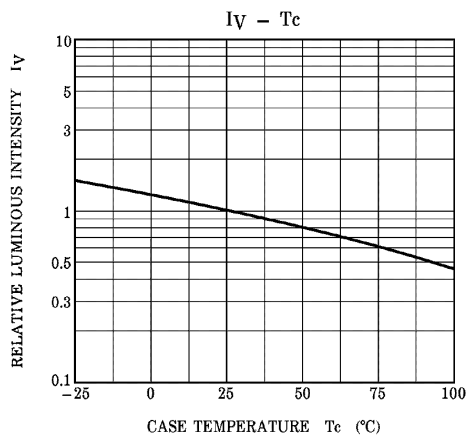
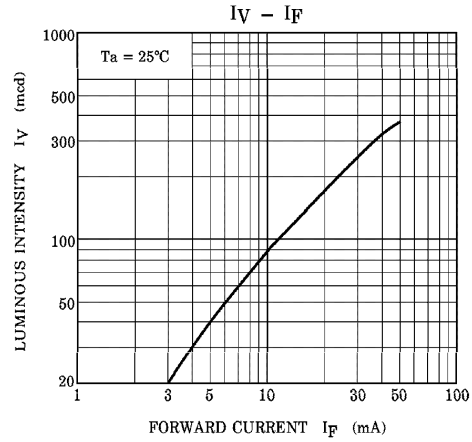
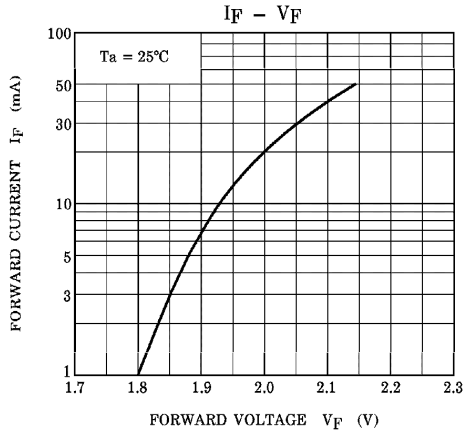

TLPGE1100 Graphs

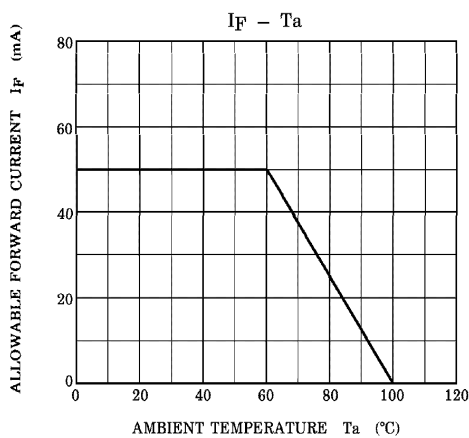
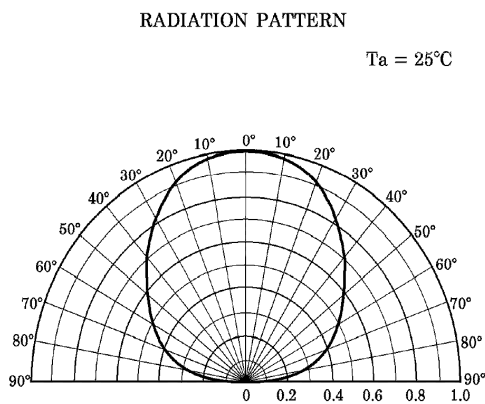
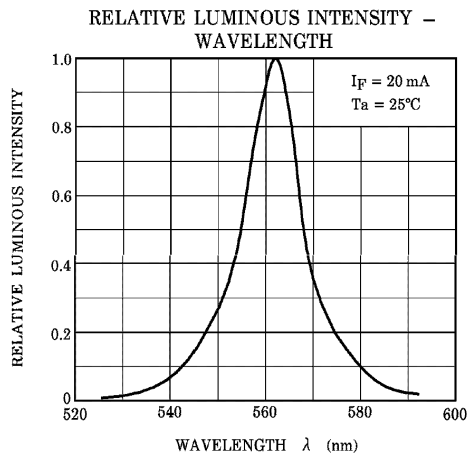
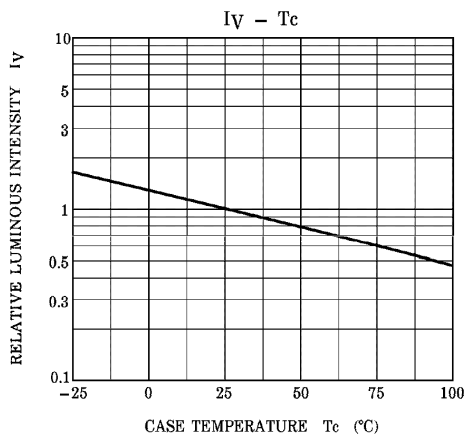
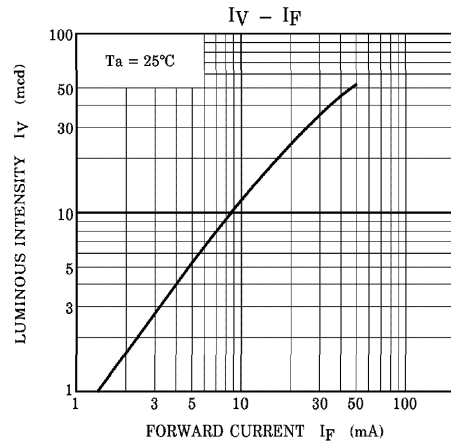
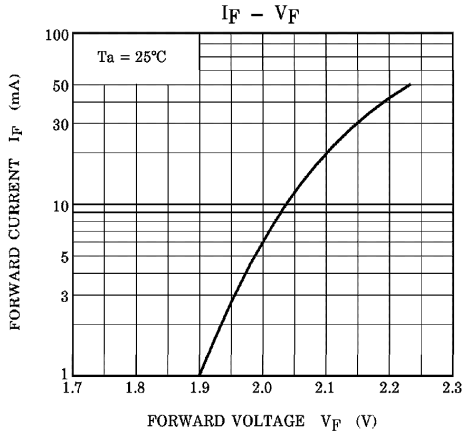

TLRE1100 Graphs

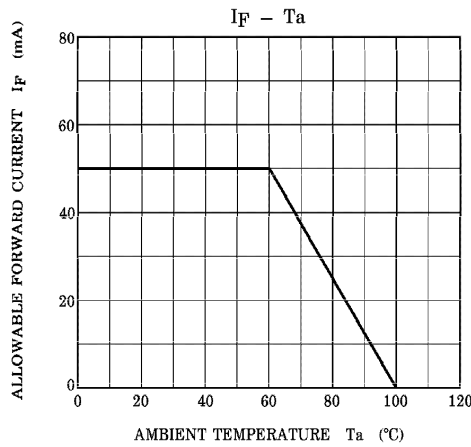
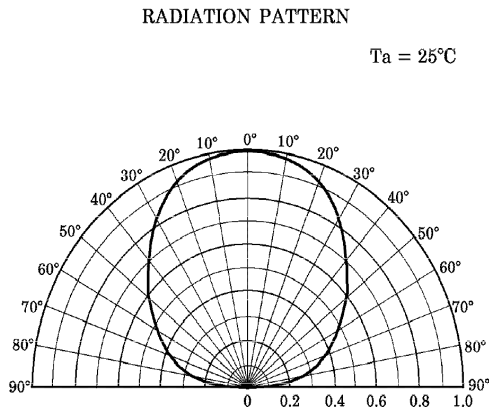
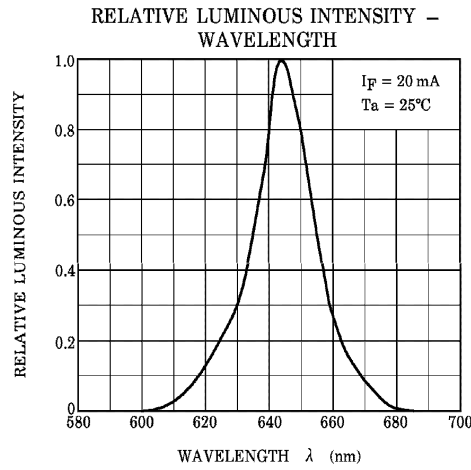
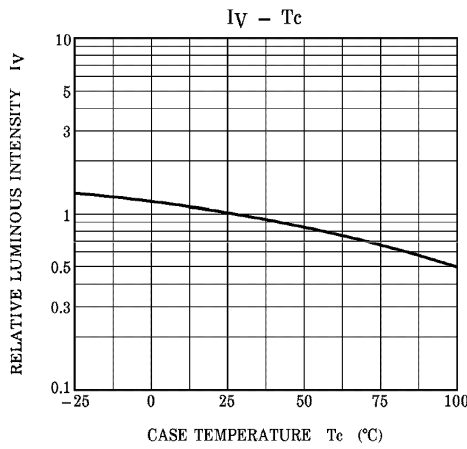
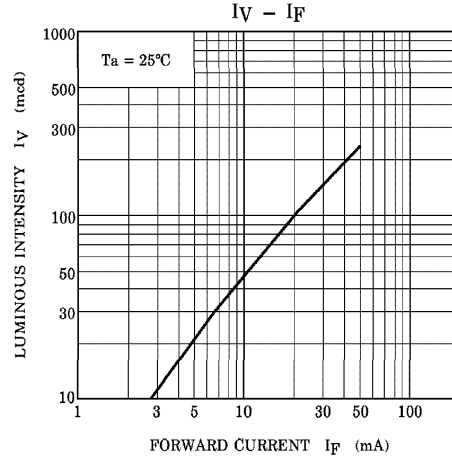
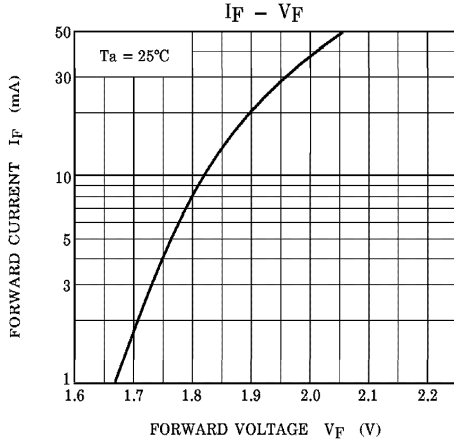

TLSE1100 Graphs

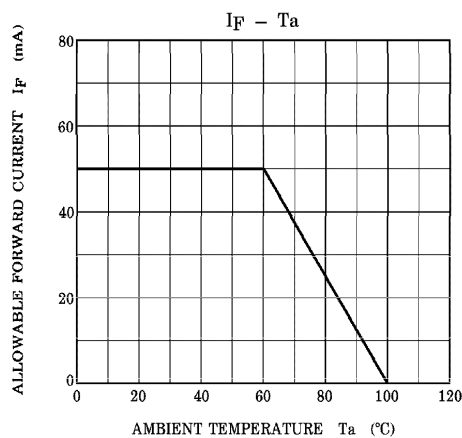
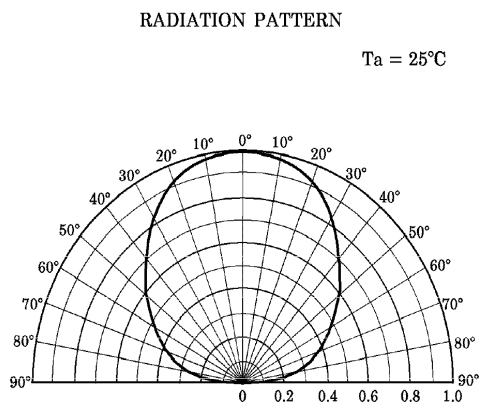
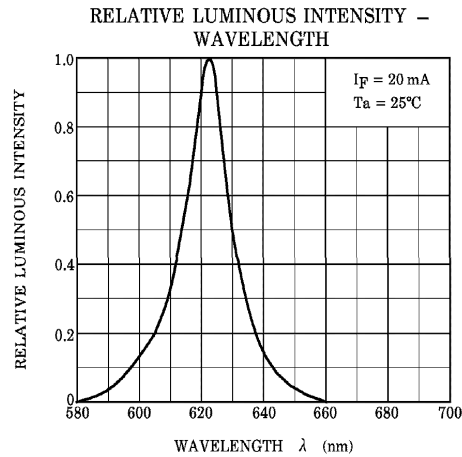
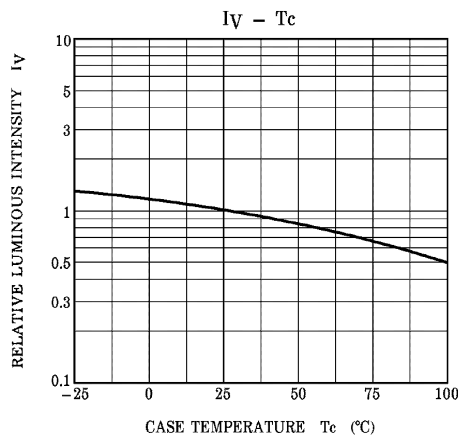
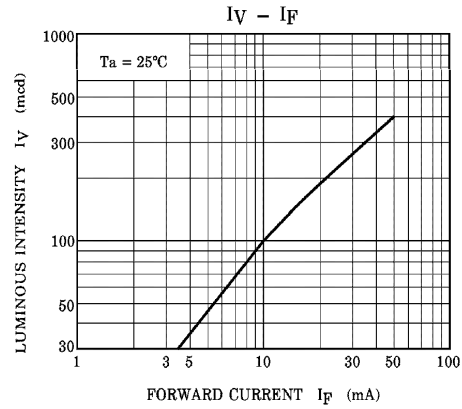
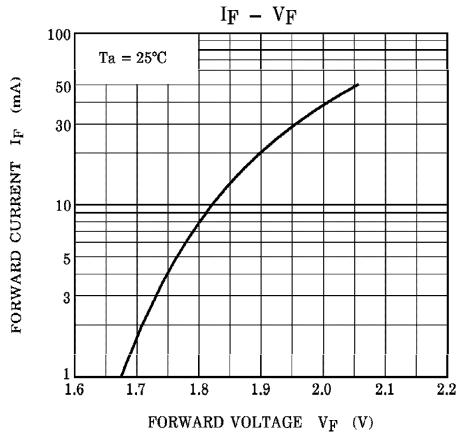

TLYE1100 Graphs

