

TOSHIBA SOLID STATE AC RELAY

TSS5G45S, TSS5J45S

OPTICALLY ISOLATED, ZERO VOLTAGE TURN-ON, ZERO CURRENT TURN - OFF, NORMALLY OPEN SSR

Unit in mm

- COMPUTER PERIPHERALS
- MACHINE TOOL CONTROLS
- PROCESS CONTROL SYSTEMS
- TRAFFIC CONTROL SYSTEMS

- R.M.S On-State Current : $I_T(\text{RMS}) = 5\text{A}$
- Repetitive Peak Off-State Voltage : $V_{\text{DRM}} = 400, 600\text{V}$
- TTL Compatible
- Isolation Voltage : $1500\text{V AC (t=1min.)}$
- Including Snubber Network

MAXIMUM RATINGS ($T_a = 25^\circ\text{C}$)
INPUT (CONTROL)

CHARACTERISTIC	SYMBOL	RATING	UNIT
Control Input Voltage (DC) (Note 1)	$V_F(\text{IN})$	6	V
Control Input Current (DC)	$I_F(\text{IN})$	20	mA

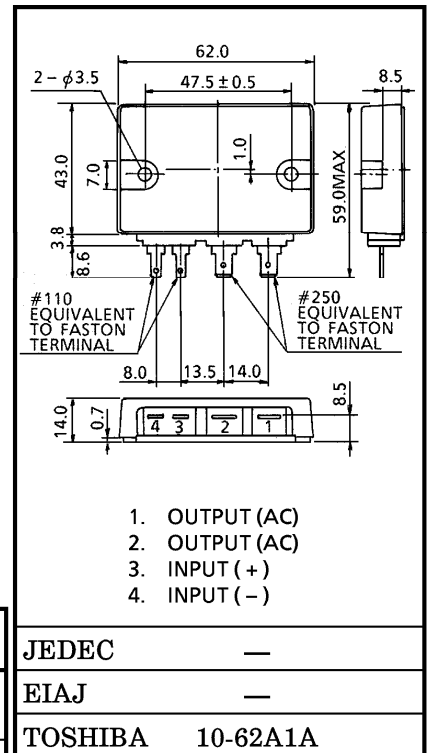

Weight : 50g

OUTPUT (LOAD)

Repetitive Peak Off-State Voltage	TSS5G45S	V_{DRM}	400	V
	TSS5J45S		600	
Nominal AC Line Voltage	TSS5G45S	V_{AC}	120	V
	TSS5J45S		240	
R.M.S On-State Current		$I_T(\text{RMS})$	5	A
Peak One Cycle Surge On-State Current (Non-Repetitive)		I_{TSM}	70 (50Hz)	A
Operating Frequency Range		f	45~65	Hz
Isolation Voltage (t=1min., Input to Output and Input/Output to Base)		BV_S/AC	1500	V
Operating Temperature Range		T_{opr}	-30~80	°C
Storage Temperature Range		T_{stg}	-30~80	°C

- Note 1 : Driving input rating : Insert an external resistance into SSR when the power supply over 6V is used.
- Note 2 : Don't dip the SSR body into the organic solvent like Trichloroethylene, when washing the flux on the terminal.
- Note 3 : For installation of SSR, use spring-wahers, etc., to prevent screws from loosening.

**ELECTRICAL CHARACTERISTICS (Ta = 25°C)
INPUT (CONTROL)**

CHARACTERISTIC	SYMBOL	TEST CONDITION	MIN.	TYP.	MAX.	UNIT
Pick Up Voltage	V_{FT}	$V_{AC} = 100V_{rms}$ Resistive Load ($R_L = 100\Omega$)	—	—	4.5	V
Drop Out Voltage	V_{FD}		1.0	—	—	V
Input Resistance	R (IN)		—	300	—	Ω

OUTPUT (LOAD)

Off-State Leakage Current	TSS5G45S	I_{OL}	$V_{AC} = 100V_{rms}, f = 50Hz$	—	—	7	mA
	TSS5J45S		$V_{AC} = 200V_{rms}, f = 50Hz$	—	—	14	
Peak On-State Voltage	V_{TM}	$I_{TM} = 12A$		—	—	1.9	V
Peak Turn-On Voltage	V_{ON}	$V_{AC} = 100V_{rms}, f = 50Hz$ (Fig.2)		—	—	7	V
dv / dt (Off-State)	dv / dt	$V_{DRM} = 0.7 \times \text{Rated}$		50	—	—	V / μs
dv / dt (Commutaing)	(dv / dt) c	$V_{DRM} = 0.7 \times \text{Rated}, I_T = 8A$		2	—	—	V / μs
Turn-On Time	t_{on}	$V_{AC} = 100V_{rms}$ Resistive Load ($R_L = 100\Omega$)		—	—	1 / 2	Cycle
Turn-Off Time	t_{off}		—	—	1 / 2		
Isolation Resistance	R_S	$V = 1kV, R.H = 40 \sim 60\%$		—	10^9	—	Ω
Thermal Resistance	$R_{th(j-c)}$	AC		—	—	5	$^{\circ}C / W$

EQUIVALEN CIRCUIT

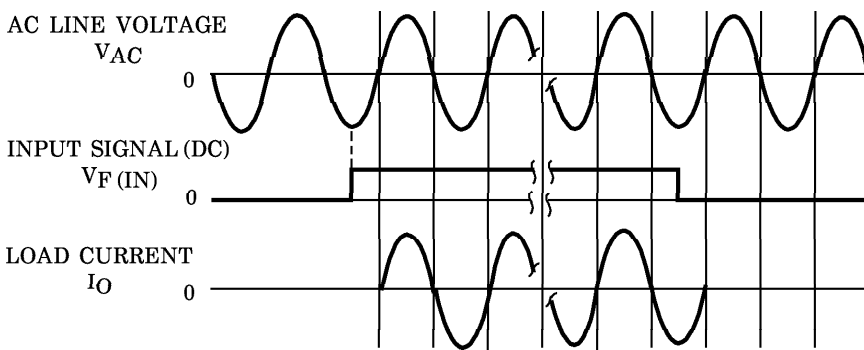
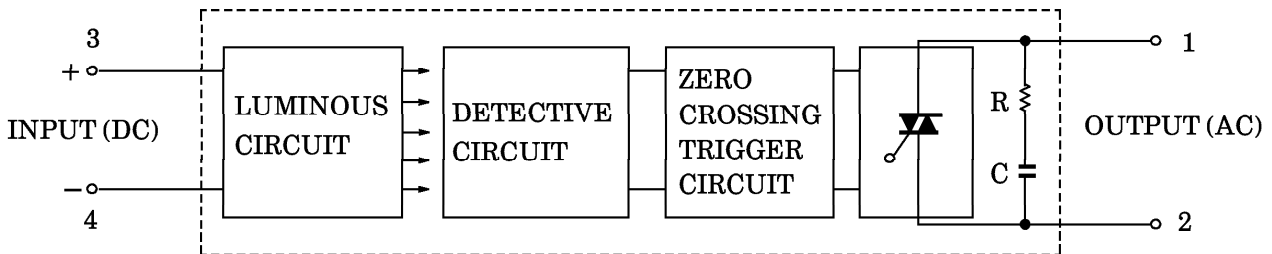

Fig.1 ZERO VOLTAGE SWITCHING WAVEFORM

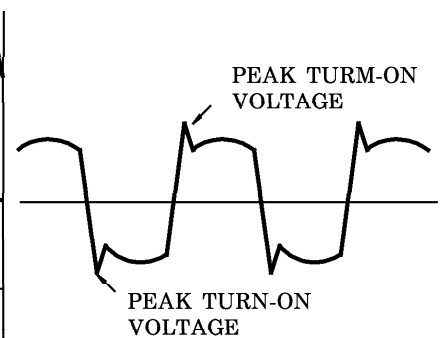
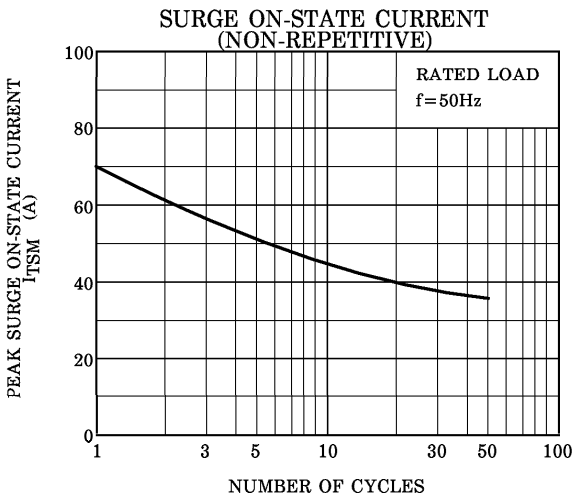
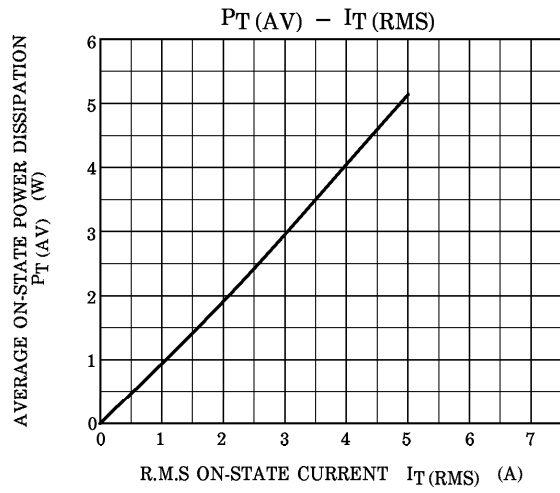
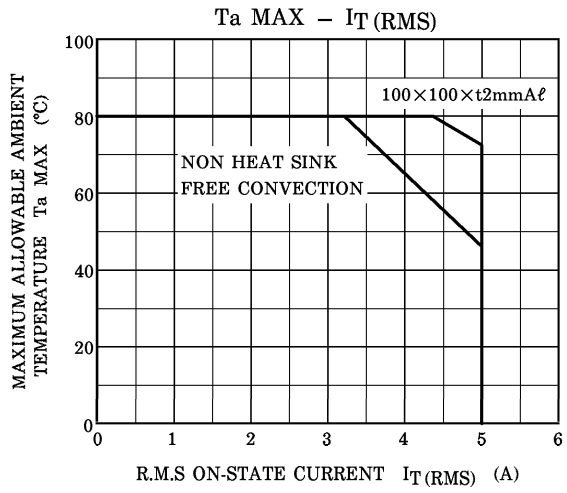

Fig.2 PEAK TURN-ON VOLTAGE WAVEFORM



RESTRICTIONS ON PRODUCT USE

000707EBA

- TOSHIBA is continually working to improve the quality and reliability of its products. Nevertheless, semiconductor devices in general can malfunction or fail due to their inherent electrical sensitivity and vulnerability to physical stress. It is the responsibility of the buyer, when utilizing TOSHIBA products, to comply with the standards of safety in making a safe design for the entire system, and to avoid situations in which a malfunction or failure of such TOSHIBA products could cause loss of human life, bodily injury or damage to property. In developing your designs, please ensure that TOSHIBA products are used within specified operating ranges as set forth in the most recent TOSHIBA products specifications. Also, please keep in mind the precautions and conditions set forth in the "Handling Guide for Semiconductor Devices," or "TOSHIBA Semiconductor Reliability Handbook" etc..
- The TOSHIBA products listed in this document are intended for usage in general electronics applications (computer, personal equipment, office equipment, measuring equipment, industrial robotics, domestic appliances, etc.). These TOSHIBA products are neither intended nor warranted for usage in equipment that requires extraordinarily high quality and/or reliability or a malfunction or failure of which may cause loss of human life or bodily injury ("Unintended Usage"). Unintended Usage include atomic energy control instruments, airplane or spaceship instruments, transportation instruments, traffic signal instruments, combustion control instruments, medical instruments, all types of safety devices, etc.. Unintended Usage of TOSHIBA products listed in this document shall be made at the customer's own risk.
- The products described in this document are subject to the foreign exchange and foreign trade laws.
- The information contained herein is presented only as a guide for the applications of our products. No responsibility is assumed by TOSHIBA CORPORATION for any infringements of intellectual property or other rights of the third parties which may result from its use. No license is granted by implication or otherwise under any intellectual property or other rights of TOSHIBA CORPORATION or others.
- The information contained herein is subject to change without notice.