

BIPOLAR ANALOG INTEGRATED CIRCUIT

μ PC1676G

GENERAL PURPOSE WIDE BAND AMPLIFIER

DESCRIPTION

The μ PC1676G is a silicon monolithic integrated circuit employing small package (4pins mini mold) and designed for use as a wide band amplifier covers from HF band to UHF band.

FEATURES

- Excellent frequency response : 1.2 GHz TYP.
@ 3 dB down below flat gain.
- High power gain : 22 dB TYP. @ f = 0.5 GHz.
- High isolation.
- Super small package.
- Uni- and low voltage operation : $V_{CC} = 5\text{ V}$
- Input and output matching 50 Ω .

ABSOLUTE MAXIMUM RATINGS ($T_A = 25\text{ }^\circ\text{C}$)

Supply Voltage	V_{CC}	6	V
Total Power Dissipation	P_T	200	mW
Operating Temperature	T_{opt}	-40 to +85	$^\circ\text{C}$
Storage Temperature	T_{stg}	-55 to +150	$^\circ\text{C}$

ELECTRICAL CHARACTERISTICS ($T_A = 25\text{ }^\circ\text{C}$, $V_{CC} = 5\text{ V}$)

CHARACTERISTIC	SYMBOL	MIN.	TYP.	MAX.	UNIT	TEST CONDITIONS
Circuit Current	I_{CC}	14	19	24	mA	No Signal
Power Gain	G_P	19	22	24	dB	f = 0.5 GHz
Noise Figure	NF		4.5	6.0	dB	f = 0.5 GHz
Upper Limit Operating Frequency	f_u	1.0	1.2		GHz	3 dB down below flat gain
Isolation	ISL	24	28		dB	f = 0.5 GHz
Input Return Loss	RL_{in}	9	12		dB	f = 0.5 GHz
Output Return Loss	RL_{out}	6	9		dB	f = 0.5 GHz
Maximum Output Level	P_o	3	5		dBm	f = 0.5 GHz, $P_{in} = 0\text{ dBm}$

NEC cannot assume any responsibility for any circuits shown or represent that they are free from patent infringement.

TYPICAL CHARACTERISTICS ($T_A = 25^\circ\text{C}$)

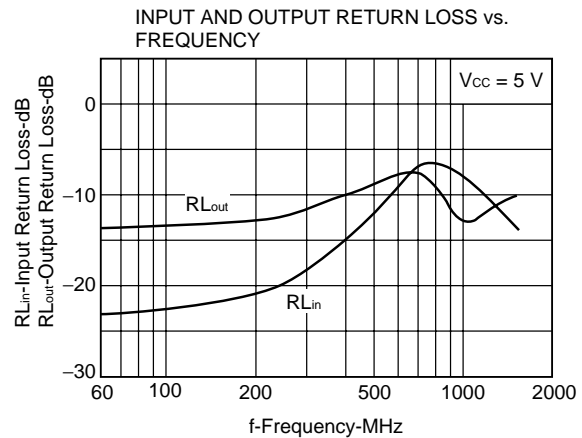
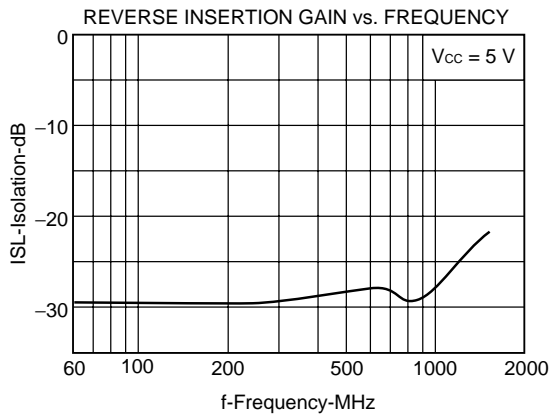
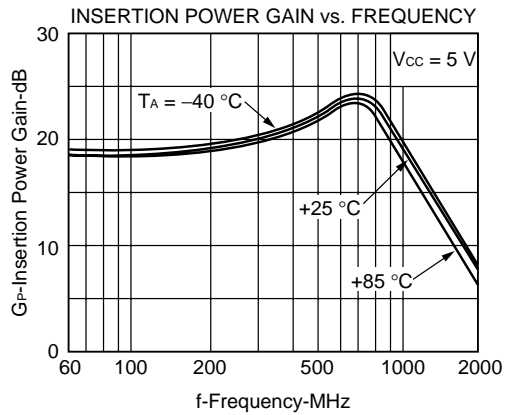
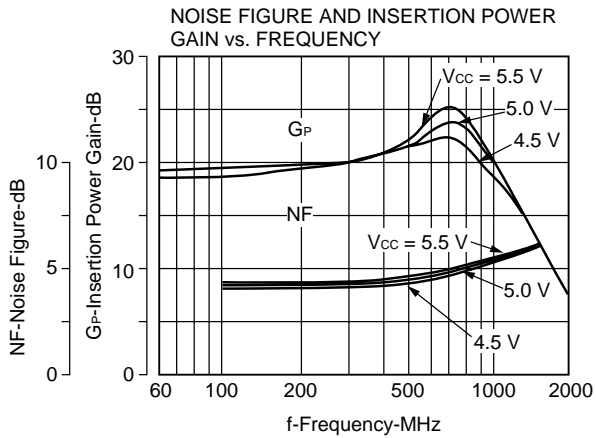
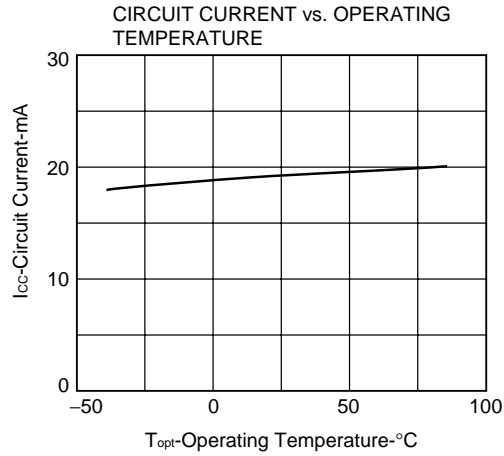
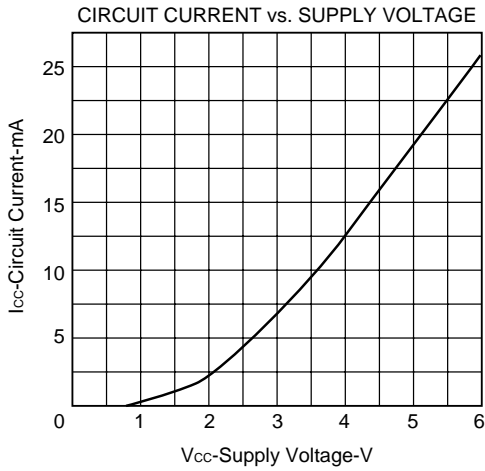

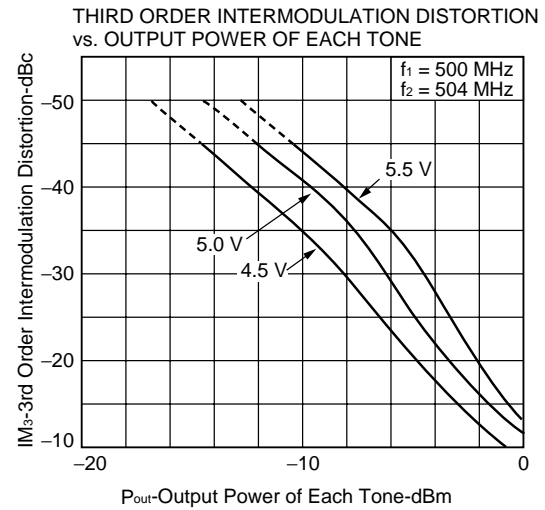
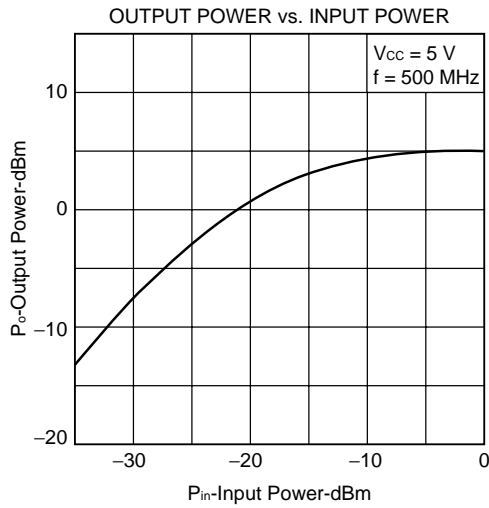

S-PARAMETER

$V_{CC} = 5\text{ V}$, $Z_0 = 50$

f (MHz)	$ S_{11} $	$\angle S_{11}$	$ S_{21} $	$\angle S_{21}$	$ S_{12} $	$\angle S_{12}$	$ S_{22} $	$\angle S_{22}$
100	0.072	-26.5	8.955	-15.3	0.034	-2.0	0.220	171.2
200	0.093	-63.5	9.327	-31.3	0.035	-3.4	0.233	161.3
400	0.175	-120.4	11.021	-66.2	0.038	-8.4	0.303	139.4
600	0.355	-176.4	14.504	-114.3	0.042	-18.4	0.408	107.7
800	0.485	118.7	14.530	177.1	0.037	-25.7	0.361	65.5
1000	0.387	77.5	9.478	123.1	0.044	-20.5	0.231	61.6
1200	0.298	59.2	6.301	85.6	0.057	-28.3	0.251	68.0
1400	0.243	50.5	4.562	53.8	0.070	-41.5	0.292	61.9
1600	0.208	47.1	3.506	24.5	0.083	-56.4	0.313	51.5

PACKAGE DIMENSIONS

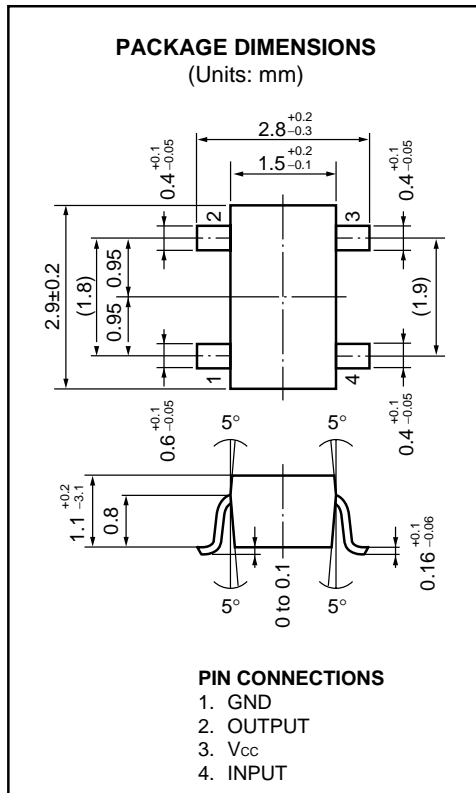

EQUIVALENT CIRCUIT

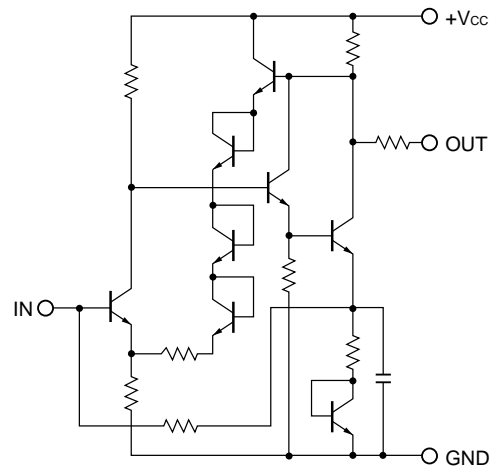

[MEMO]

[MEMO]

[MEMO]

No part of this document may be copied or reproduced in any form or by any means without the prior written consent of NEC Corporation. NEC Corporation assumes no responsibility for any errors which may appear in this document.

NEC Corporation does not assume any liability for infringement of patents, copyrights or other intellectual property rights of third parties by or arising from use of a device described herein or any other liability arising from use of such device. No license, either express, implied or otherwise, is granted under any patents, copyrights or other intellectual property rights of NEC Corporation or others.

While NEC Corporation has been making continuous effort to enhance the reliability of its semiconductor devices, the possibility of defects cannot be eliminated entirely. To minimize risks of damage or injury to persons or property arising from a defect in an NEC semiconductor device, customers must incorporate sufficient safety measures in its design, such as redundancy, fire-containment, and anti-failure features.

NEC devices are classified into the following three quality grades:

"Standard", "Special", and "Specific". The Specific quality grade applies only to devices developed based on a customer designated "quality assurance program" for a specific application. The recommended applications of a device depend on its quality grade, as indicated below. Customers must check the quality grade of each device before using it in a particular application.

Standard: Computers, office equipment, communications equipment, test and measurement equipment, audio and visual equipment, home electronic appliances, machine tools, personal electronic equipment and industrial robots

Special: Transportation equipment (automobiles, trains, ships, etc.), traffic control systems, anti-disaster systems, anti-crime systems, safety equipment and medical equipment (not specifically designed for life support)

Specific: Aircrafts, aerospace equipment, submersible repeaters, nuclear reactor control systems, life support systems or medical equipment for life support, etc.

The quality grade of NEC devices is "Standard" unless otherwise specified in NEC's Data Sheets or Data Books. If customers intend to use NEC devices for applications other than those specified for Standard quality grade, they should contact an NEC sales representative in advance.

Anti-radioactive design is not implemented in this product.