

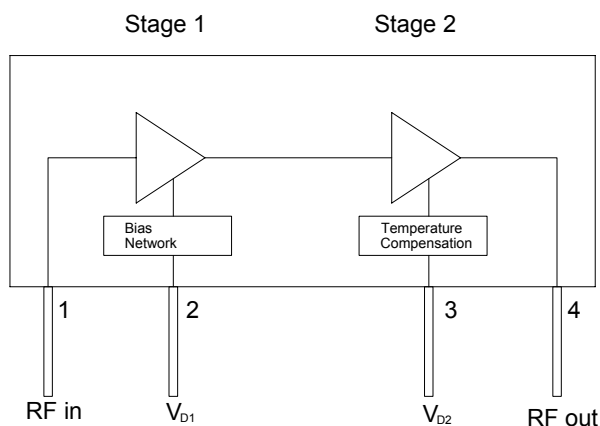

Product Description

Sirenza Microdevices' **XD010-14S-D4F** 15W power module is a robust 2-stage Class A/AB amplifier module for use in GSM and EDGE RF applications. This module is optimized to minimize the EVM at typical operating levels. The power transistors are fabricated using Sirenza's latest, high performance LDMOS process. This unit operates from a single voltage supply and has internal temperature compensation of the bias voltage to ensure stable performance over the full temperature range. It is a drop-in, no-tune solution for medium power applications requiring high efficiency, excellent linearity, and unit-to-unit repeatability. It is internally matched to 50 ohms.

Functional Block Diagram



Case Flange = Ground

XD010-14S-D4F

**925-960 MHz Class A/AB
15W Power Amplifier Module**

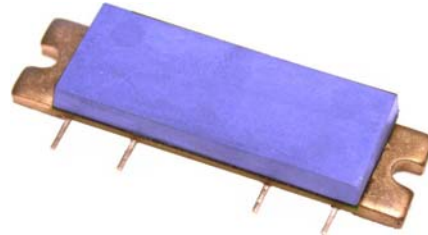

Product Features

- 50 Ω RF impedance
- 15W Output P_{1dB}
- Single Supply Operation : Nominally 28V
- High Gain: 32 dB at 942 MHz
- High Efficiency: 31% at 942 MHz
- Robust 8000V ESD (HBM), Class 3B
- High Peak Power for Lower BER
- Ultra-low EVM

Applications

- Base Station PA driver
- Repeater
- GSM / EDGE

Key Specifications

Symbol	Parameter	Unit	Min.	Typ.	Max.
Frequency	Frequency of Operation	MHz	925		960
P_{1dB}	Output Power at 1dB Compression (single tone)	W	10	15	
Gain	Gain at 12W Output Power (CW)	dB	30	32	35
Gain Flatness	Peak-to-Peak Gain Variation	dB		0.4	1.0
IRL	Input Return Loss 12W CW	dB	12	18	
Efficiency	Drain Efficiency at 12W CW	%	27	31	
Linearity	RMS EVM at 8W EDGE output	%		2.5	
	Peak EVM at 8W EDGE output	%		6.7	
	3 rd Order IMD at 12W PEP (Two Tone)	dBc		-35	-30
Delay	Signal Delay from Pin 1 to Pin 4	nS		2.5	
Phase Linearity	Deviation from Linear Phase (Peak-to-Peak)	Deg		0.5	
$R_{TH, j1}$	Thermal Resistance Stage 1 (Junction-to-Case)	$^{\circ}C/W$		11	
$R_{TH, j-2}$	Thermal Resistance Stage 2 (Junction-to-Case)	$^{\circ}C/W$		4	

Test Conditions $Z_{in} = Z_{out} = 50\Omega$, $V_{DD} = 28.0V$, $I_{DQ1} = 230$ mA, $I_{DQ2} = 158$ mA, $T_{Flange} = 25^{\circ}C$

Quality Specifications

Parameter		Unit	Typical
ESD Rating	Human Body Model, JEDEC Document - JESD22-A114-B	V	8000
MTTF	85°C Leadframe, 200°C Channel	Hours	1.2 X 10 ⁶

Pin Description

Pin #	Function	Description
1	RF Input	Module RF input. This pin is internally connected to DC ground. Do not apply DC voltages to the RF leads. Care must be taken to protect against video transients that may damage the active devices.
2	V _{D1}	This is the drain voltage for the first stage. Nominally +28Vdc
3	V _{D2}	This is the drain voltage for the 2 nd stage of the amplifier module. The 2 nd stage gate bias is temperature compensated to maintain constant quiescent drain current over the operating temperature range. See Note 1.
4	RF Output	Module RF output. This pin is internally connected to DC ground. Do not apply DC voltages to the RF leads. Care must be taken to protect against video transients that may damage the active devices.
Flange	Gnd	Exposed area on the bottom side of the package needs to be mechanically attached to the ground plane of the board for optimum thermal and RF performance. See mounting instructions in application note AN-060 on Sirenza's web site.

Simplified Device Schematic

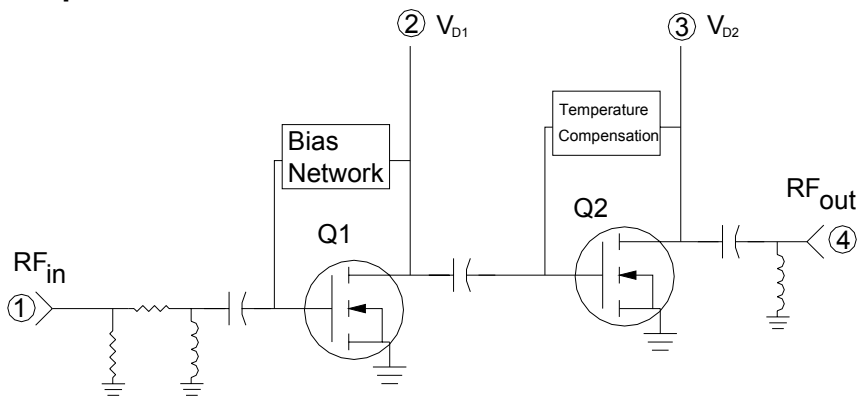

Case Flange = Ground

Absolute Maximum Ratings

Parameters	Value	Unit
1 st Stage Bias Voltage (V _{D1})	35	V
2 nd Stage Bias Voltage (V _{D2})	35	V
RF Input Power	+20	dBm
Load Impedance for Continuous Operation Without Damage	5:1	VSWR
Output Device Channel Temperature	+200	°C
Operating Temperature Range	-20 to +90	°C
Storage Temperature Range	-40 to +100	°C

Operation of this device beyond any one of these limits may cause permanent damage. For reliable continuous operation see typical setup values specified in the table on page one.

Note 1:

The internally generated gate voltage is thermally compensated to maintain constant quiescent current over the temperature range listed in the data sheet. No compensation is provided for gain changes with temperature. This can only be accomplished with AGC external to the module.

Note 2:

Internal RF decoupling is included on all bias leads. No additional bypass elements are required, however some applications may require energy storage on the drain leads to accommodate time-varying waveforms.

Note 3:

This module was designed to have its leads hand soldered to an adjacent PCB. The maximum soldering iron tip temperature should not exceed 700° C, and the soldering iron tip should not be in direct contact with the lead for longer than 10 seconds. Refer to app note AN060 (www.sirenza.com) for further installation instructions.



Caution: ESD Sensitive

Appropriate precaution in handling, packaging and testing devices must be observed.

Typical Performance Curves

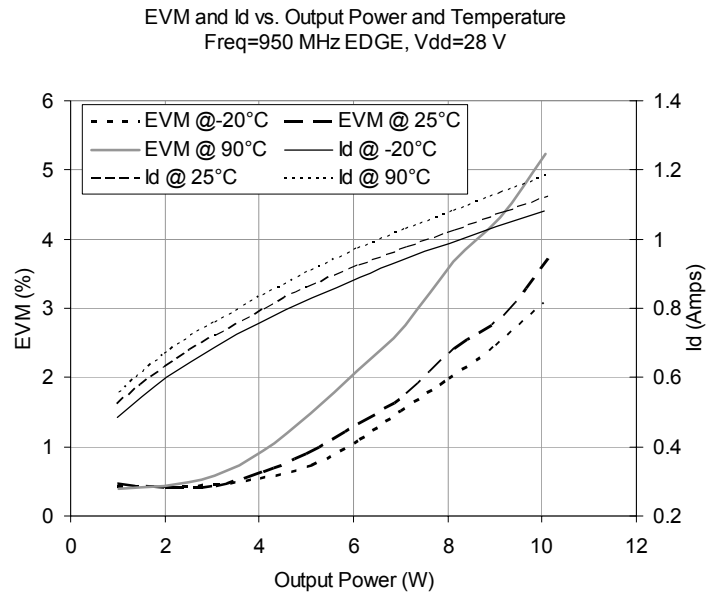
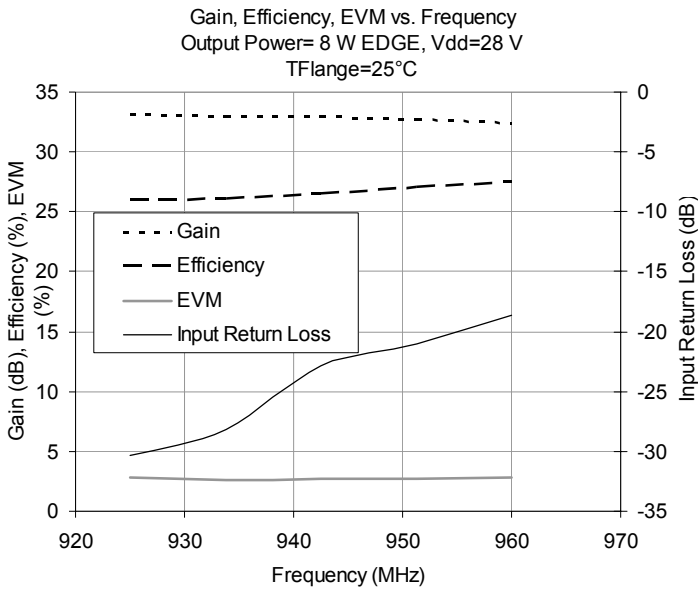
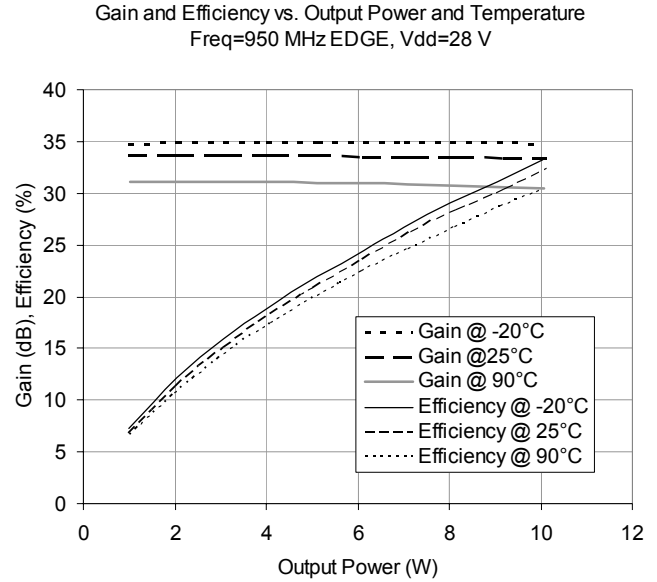
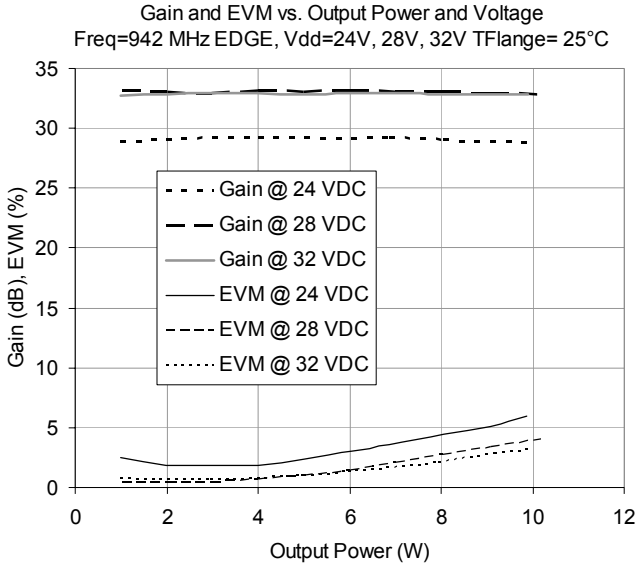

Test Board Schematic with module connections shown

Test Board Bill of Materials

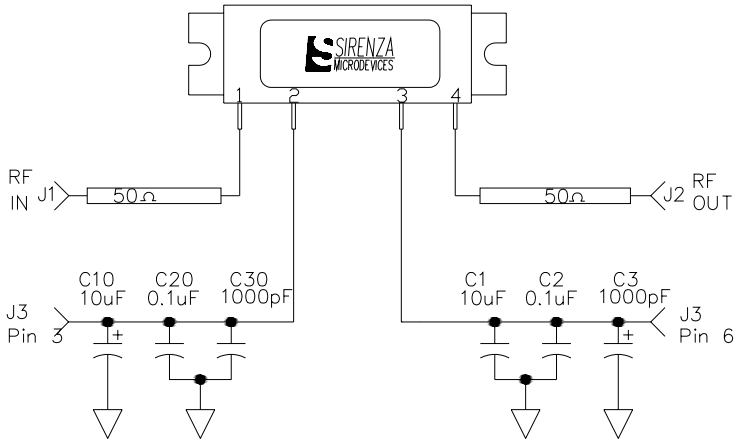

Component	Description	Manufacturer
PCB	Rogers 4350, $\epsilon_r=3.5$ Thickness=30mils	Rogers
J1, J2	SMA, RF, Panel Mount Tab W / Flange	Johnson
J3	MTA Post Header, 6 Pin, Rect- angle, Polarized, Surface Mount	AMP
C1, C10	Cap, 10μF, 35V, 10%, Tant, Elect, D	Kemet
C2, C20	Cap, 0.1μF, 100V, 10%, 1206	Johanson
C3, C30	Cap, 1000pF, 100V, 10%, 1206	Johanson
C25, C26	Cap, 68pF, 250V, 5%, 0603	ATC
C21, C22	Cap, 0.1μF, 100V, 10%, 0805	Panasonic
C23, C24	Cap, 1000pF, 100V, 10%, 0603	AVX
Mounting Screws	4-40 X 0.250"	Various

Test Board Layout

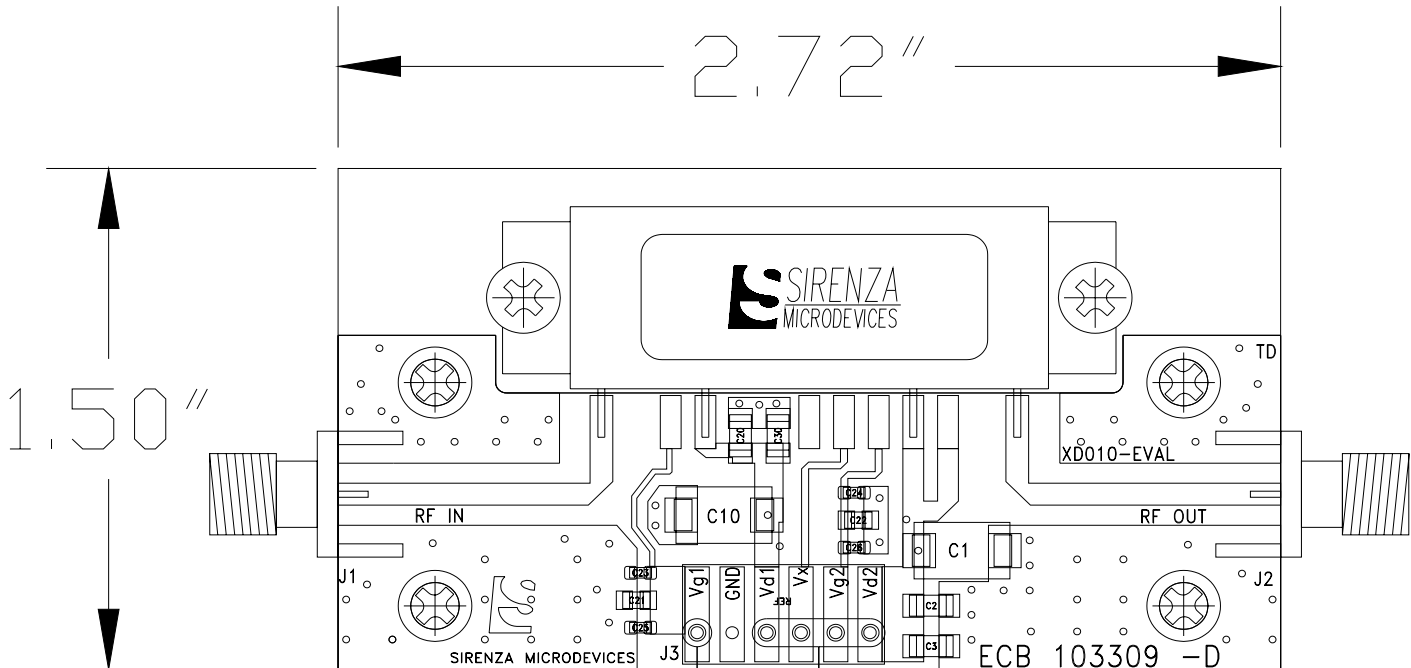

To receive Gerber files, DXF drawings, a detailed BOM, and assembly recommendations for the test board with fixture, contact applications support at support@sirenza.com. Data sheet for evaluation circuit (XD010-EVAL) available from Sirenza website.

Package Outline Drawing

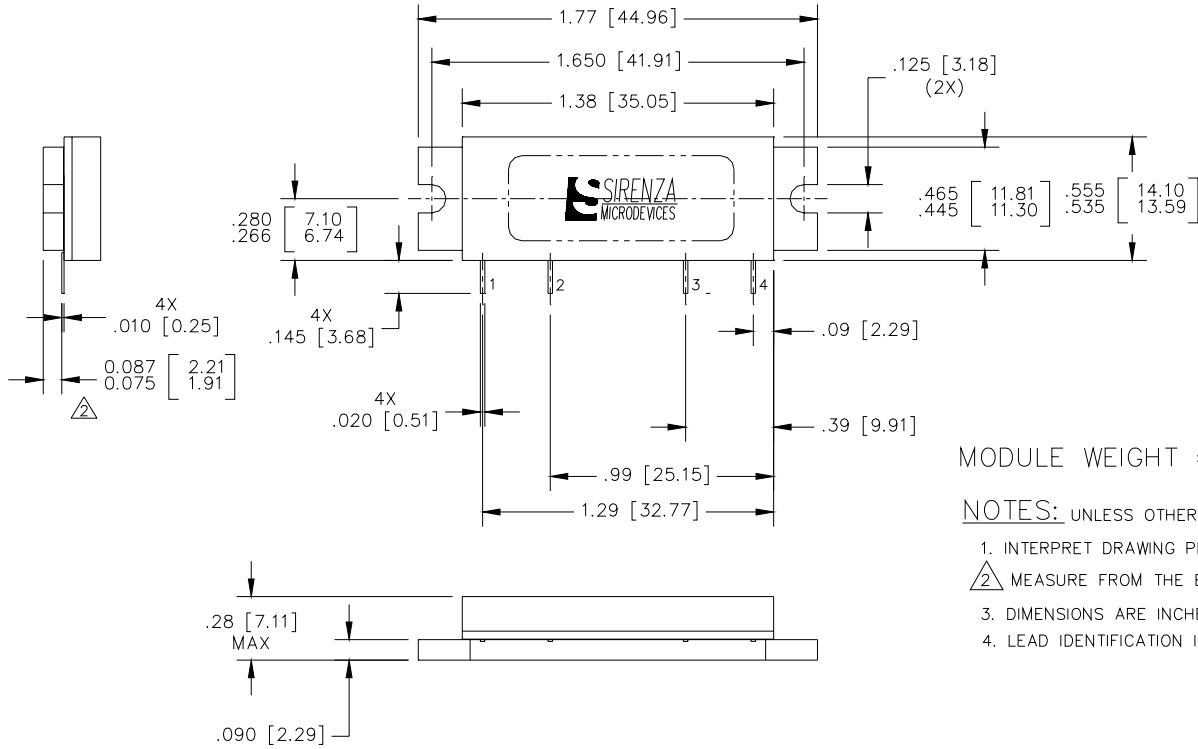

MODULE WEIGHT = 12gm Nominal

NOTES: UNLESS OTHERWISE SPECIFIED

1. INTERPRET DRAWING PER ANSI Y14.5.
2. MEASURE FROM THE BOTTOM OF THE LEADS.
3. DIMENSIONS ARE INCHES [MM].
4. LEAD IDENTIFICATION IS FOR REFERENCE ONLY.

Recommended PCB Cutout and Landing Pads for the D4F Package

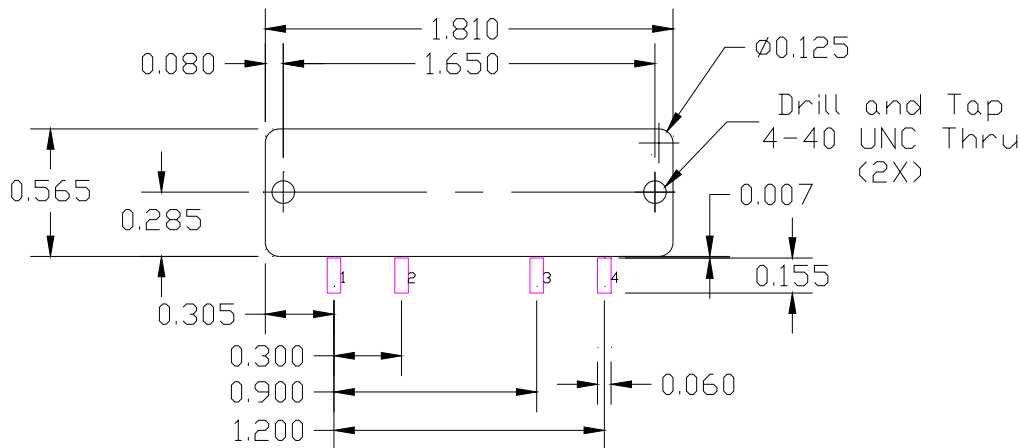

Note 3: Dimensions are in inches

Refer to Application note AN-060 "Installation Instructions for XD Module Series" for additional mounting info. App note available at www.sirenza.com