

ZXBM1017

VARIABLE SPEED SINGLE- PHASE BLDC MOTOR CONTROLLER

DESCRIPTION

The ZXBM1017 is a Single-Phase, DC brushless motor pre-driver with PWM variable speed control and current limit features suitable for fans, blowers and pump motors. Where the system dictates, this device can be controlled via an external voltage, PWM signal or thermistor.

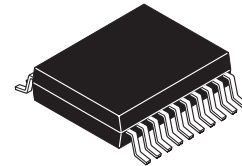

TSSOP20

FEATURES

- Compliant with external PWM speed control
- Compliant with thermistor control
- Minimum speed setting
- Low noise
- Auto restart
- Built in Hall amplifier
- Speed pulse (FG) and lock rotor (RD) outputs
- Current Limiting
- Variable commutation delay
- Up to 18V input voltage (60V with external regulator)
- Small TSSOP20 package
- Lead free product

APPLICATIONS

- Mainframe and personal computer fans and blowers
- Instrumentation fans
- Central heating blowers
- Automotive climate control

ORDERING INFORMATION

DEVICE	REEL SIZE	TAPE WIDTH	QUANTITY PER REEL
ZXBM1017ST20TC	13" (330mm)	16mm	2,500

DEVICE MARKING

- ZETEX
ZXBM1017
Date code

ZXBM1017

Absolute Maximum Ratings

Parameter	Symbol	Limits	Unit
Supply Voltage	V _{CCmax}	-0.6 to 20	V
Input Current	I _{CCmax}	200	mA
Maximum Input Voltage	V _{Imax}	-0.6 to V _{CC} +0.5	V
Maximum Output Voltage	V _{Omax}	-0.6 to V _{CC} +0.5	V
Power Dissipation	P _{Dmax}	800	mW
Operating Temp.	T _{OPR}	-40 to 110	°C
Storage Temp.	T _{STG}	-55 to 125	°C

1) Maximum allowable Power Dissipation, P_D, is shown plotted against Ambient Temperature, T_A, in the accompanying Power Derating Curve, indicating the Safe Operating Area for the device.

2) Power consumed by the device, P_T, can be calculated from the equation:

$$P_T = P_Q + P_{PhHi} + P_{PhLo} + P_{TR} + P_{HB} + P_{FGRD}$$

where P_Q is power dissipated under quiescent current conditions, given by:

$$P_Q = V_{CC} \times I_{CC}$$

where V_{CC} is the maximum application device Supply Voltage

and I_{CC} is the maximum Supply Current given in the Electrical Characteristics

and P_{PhHi} is power generated due to either one of the phase outputs Ph1Hi or Ph2Hi being active, given by:

$$P_{PhHi} = I_{OL} \times V_{OL}$$

where I_{OL} is the maximum application Ph1Hi and Ph2Hi output currents

and V_{OL} is the maximum Low Level Output Voltage for the Ph1Hi and Ph2Hi outputs given in the Electrical Characteristics

and P_{PhLo} is power generated due to either one of the phase outputs Ph1Lo or Ph2Lo being active, given by:

$$P_{PhLo} = I_{OH} \times (V_{CC} - V_{OH})$$

where I_{OH} is the maximum application Ph1Lo and Ph2Lo output currents

and V_{CC} is the maximum application device Supply Voltage

and V_{OH} is the minimum High Level Output Voltage for the Ph1Lo and Ph2Lo outputs given in the Electrical Characteristics.

and P_{TR} is power generated due to the Network Reference source current, given by:

$$P_{TR} = I_{OThRef} \times (V_{CC} - V_{ThRef})$$

where I_{OThRef} is the maximum application ThRef output current

and V_{CC} is the maximum application device Supply Voltage

and V_{ThRef} is the Network Reference voltage

and P_{HB} is power generated due to the Hall Bias source current, given by:

$$P_{HB} = I_{HB} \times (V_{CC} - V_{HB})$$

where I_{HB} is the maximum application Hall Bias output current

and V_{HB} is the Hall Bias voltage

and P_{FGRD} is power generated due to either or both the Frequency Generator and Locked Rotor Detect outputs being active, given by:

$$P_{FGRD} = I_{OL} \times V_{OL}$$

where I_{OL} is the maximum application FG or RD output current

and V_{OL} is the FG or RD Low Level Output Voltage

ZXBM1017

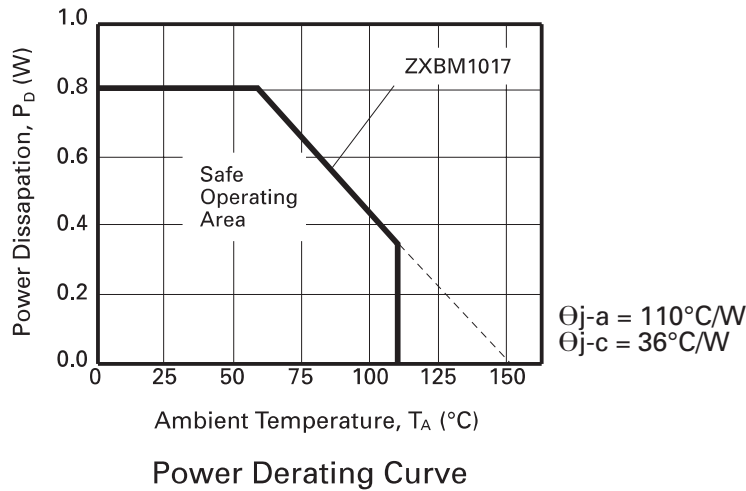

ELECTRICAL CHARACTERISTICS (at $T_{amb} = 25^\circ\text{C}$ and $V_{CC} = 12\text{V}$)

PARAMETER	SYMBOL	MIN.	TYP.	MAX.	UNIT	CONDITIONS
Supply						
Voltage	V_{CC}	4.7	-	18	V	
Current	I_{CC}	-	11	14.5	mA	No load ⁽¹⁾
Hall connections						
Hall Amp Input Voltage	V_{IN}	40	-	-	mV	diff p-p
Hall Amp Common Mode Voltage	V_{CM}	0.5	-	$V_{CC}-1.5$	V	
Hall Amp Input Offset	V_{OFS}	-	± 10	-	mV	
Hall Amp Input Current	I_{BS}	-	-400	-650	nA	
Hall Bias Voltage	V_{HB}	1.6	1.75	1.975	V	$I_{HB\ OUT} = -5\text{mA}$
Hall Bias Output Current	I_{HB}	-	-	-10	mA	
Output Drives						
Ph1Lo, Ph2Lo Output High Voltage	V_{OH}	$V_{CC}-2.2$	$V_{CC}-1.8$	-	V	$I_{OH} = 80\text{mA}$ Phase active
Ph1Lo, Ph2Lo Output Low Voltage	V_{OLA}	-	0.4	0.6	V	$I_{OL} = 32\text{mA}$ Phase active
Ph1Lo, Ph2Lo Output Low Voltage	V_{OLB}	-	0.4	0.6	V	$I_{OL} = 50\mu\text{A}$ Phase inactive
Ph1Lo, Ph2Lo Output Source Current	I_{OH}	-	-	-80	mA	
Ph1Lo, Ph2Lo Output Sink Current	I_{OL}	-	-	32	mA	
Ph1Hi, Ph2Hi Output Low Voltage	V_{OLA}	-	0.55	0.8	V	$I_{OL} = 100\text{mA}$
Ph1Hi, Ph2Hi Output Sink Current	I_{OL}	-	-	100	mA	

ZXBM1017

ELECTRICAL CHARACTERISTICS (at $T_{amb} = 25^{\circ}\text{C}$ and $V_{cc} = 12\text{V}$) (Cont.)

PARAMETER	SYMBOL	MIN.	TYP.	MAX.	UNIT	CONDITIONS
PWM Oscillator						
C_{PWM} Charge Current	I_{PWMC}	-5.3	-	-9.1	μA	
C_{PWM} Discharge Current	I_{PWMD}	55	-	105	μA	
C_{PWM} High Threshold Voltage	V_{THH}	-	3	-	V	
C_{PWM} Low Threshold Voltage	V_{THL}	-	1	-	V	
PWM Frequency	F_{PWM}		24		kHz	$C_{PWM} = 0.1\text{nF}$
Reference Voltage						
ThRef Voltage	V_{ThRef}	4.75	5.0	5.25	V	$I_{OThRef} = -10\text{mA}$
ThRef Output Current	I_{OThRef}	-	-	-10	mA	
Speed Control						
SPD Voltage Minimum	V_{SPDL}	-	1	-	V	100% PWM Drive
SPD Voltage Maximum	V_{SPDH}	-	3	-	V	0% PWM Drive
SPD Input Current	I_{ISPD}	-	-0.4	-2	μA	$V_{in} = 2\text{V}$
Minumum Speed Setting						
S_{MIN} Input Current	I_{SMIN}	-	-0.25	-0.5	μA	$V_{in} = 2\text{V}$
Rotor Lock and Auto Restart						
C_{LCK} Charge Current	I_{LCKC}	-2.7	-	-5.2	μA	
C_{LCK} Discharge Current	I_{LCKD}	0.2	-	0.42	μA	
C_{LCK} High Threshold Voltage	V_{THH}	-	3	-	V	
C_{LCK} Low Threshold Voltage	V_{THL}	-	1	-	V	
Lock condition On:Off ratio		-	1:12	-		
Current Limit						
Sense Input Current	I_{Sense}	-	-20	-100	nA	$V_{in} = 1\text{V}$, SetTh = 2V
SetTh Input Current	I_{SetTh}	-	-20	-100	nA	$V_{in} = 2\text{V}$, Sense = 1V
Output Flags						
FG & RD Output Current	I_{OL}	-	-	16	mA	
FG & RD Low Level Output Voltage	V_{OL}	-	-	0.5	V	$I_{OL} = 16\text{mA}$
Commutation Delay						
Commutation Delay	t_{ComDel}	48	-	112	μs	ComDel Open Circuit

Notes:

(1.) Measured with pins H+, H-, CLCK and CPWM = 0V and all other signal pins open circuit.

(2.) In this data sheet a negative sign for a current indicates current flowing out of the pin whilst no sign indicates current flowing into the pin

ZXBM1017

Block diagram

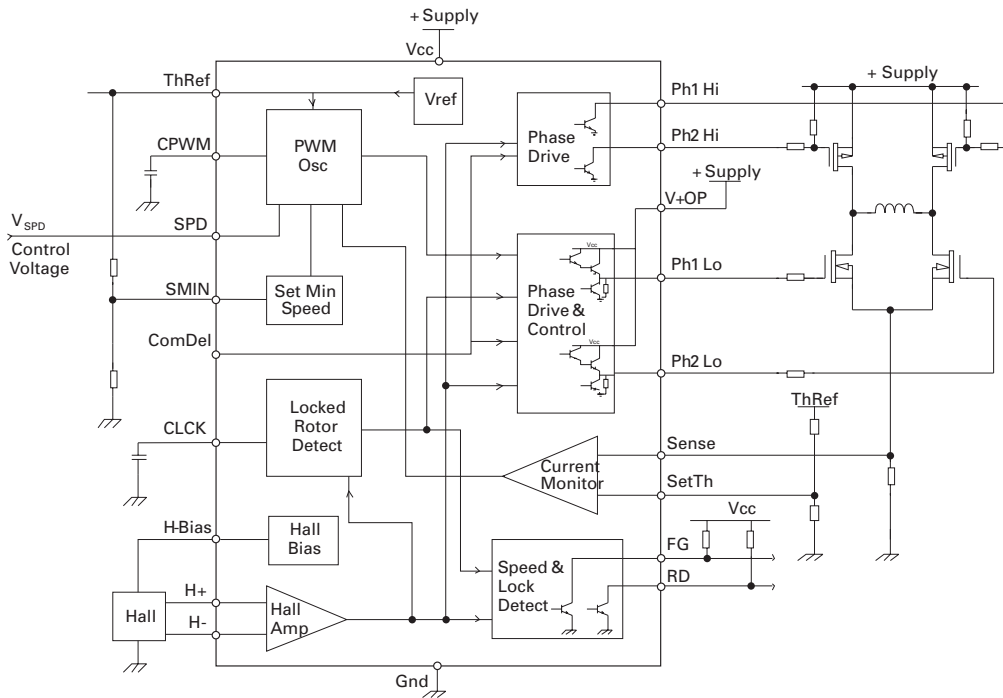

Pin Assignments

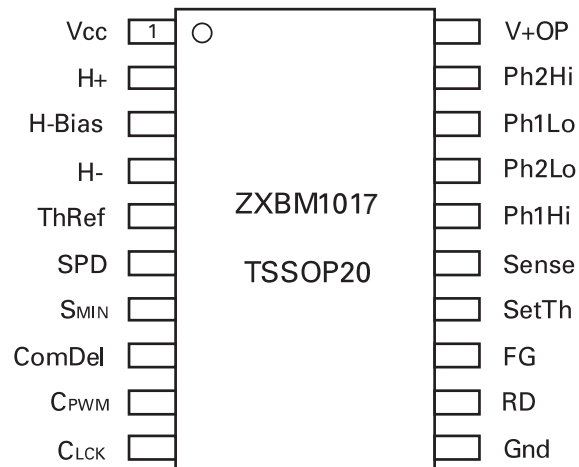

ZXBM1017

PIN FUNCTIONAL DESCRIPTION

H+ - Positive Hall input

H- - Negative Hall input

The rotor position is detected by a Hall sensor, with the output applied to the H+ and H- pins. This sensor can be either a 4 pin 'naked' Hall device or of the 3 pin buffered switching type. For a 4 pin device the differential Hall output signal is connected to the H+ and H- pins. For a buffered Hall sensor the Hall device output is attached to the H+ pin, with a pull-up attached if needed, whilst the H- pin has an external potential divider attached to hold the pin at half Vcc. When H+ is high in relation to H-, Ph2 is the active drive.

H-Bias- Hall Bias Output

This is a 1.75V nominal voltage source to bias a differential unbuffered Hall sensor when that type is used.

ThRef - Network Reference

This is a reference voltage of nominal 5V and is used by external networks to set up the SPD and SMIN pins control voltages.

It is designed for the ability to 'source' current and therefore it will not 'sink' any current from a higher voltage. The current drawn from the pin by the minimum speed potential divider to pin SMIN and any voltage setting network on the SPD pin should not exceed 10mA in total.

SPD - Speed Control Input

The voltage applied to the SPD pin provides control over the Fan Motor speed by varying the Pulse Width Modulated (PWM) drive ratio at the Ph1Lo and Ph2Lo outputs. The control signal takes the form of a voltage input of range 3V to 1V, representing 0% to 100% drive respectively.

If variable speed control is not required this pin can be left with an external potential divider to set a fixed speed or tied to ground to provide full speed i.e. 100% PWM drive.

The advantage of a fixed potential divider is so that the benefit of the current control can be achieved.

If required this pin can also be used as a disable pin. The application of a voltage >3.0V will force the PWM drive fully off, in effect disabling the drive.

SMIN - Sets Minimum Speed

A voltage can be set on this pin via a potential divider between the ThRef and Gnd. This voltage is monitored by the SPD pin such that the SPD voltage cannot rise above the SMIN Voltage. As a higher voltage on the

SPD pin represents a lower speed it therefore restricts the lower speed range of the fan. If this feature is not required the pin is left tied to ThRef so no minimum speed will be set.

If the fan is being controlled from an external voltage source either this feature should not be used or if it is required then a >1kΩ resistor should be placed in series with the SPD pin.

ComDel - Adjusts the Commutation Delay

The ZXBM1017 has a fixed internal commutation delay of 100us, however, there may be cases where this needs to be adjusted to a different value. A resistor can be attached to this pin to enable the delay to be lengthened or shortened dependant upon application.

A resistor applied between the ComDel pin and Gnd will lengthen the delay and a resistor applied between the ComDel pin and ThRef will shorten the delay. The following Table indicates the delay expected for a given resistor value.

Typical Commutation Delay

Resistor to ThRef	Resistor to Gnd	Delay (μs)
100kΩ	-	28
220kΩ	-	40
-	-	80
-	470kΩ	120
-	300kΩ	168

CPWM - Sets PWM Frequency

This pin has an external capacitor attached to set the PWM frequency for the Phase drive outputs. A capacitor value of 0.1nF will provide a PWM frequency of typically 24kHz.

The CPWM timing period (t_{PWM}) is determined by the following equation:

$$t_{PWM} = \frac{(V_{THH} - V_{THL}) \times C}{I_{PWMC}} + \frac{(V_{THH} - V_{THL}) \times C}{I_{PWMD}}$$

Where: C = CPWM +15, in pF
V_{THH} and V_{THL} are the CPWM pin threshold voltages
I_{PWMC} and I_{PWMD} are the charge and discharge currents in μA.
t_{PWM} is in μs

ZXBM1017

As these threshold voltages are nominally set to $V_{THH} = 3V$ and $V_{THL} = 1V$ the equations can be simplified as follows:

$$t_{PWM} = \frac{2C}{I_{PWMC}} + \frac{2C}{I_{PWMD}}$$

CLCK - Locked Rotor Timing Capacitor

Should the fan stop rotating for any reason, i.e. an obstruction in the fan blade or a seized bearing, then the device will enter a Rotor Locked condition. In this condition after a predetermined time (t_{lock}) the RD pin will go high and the Phase outputs will be disabled. After a further delay (t_{off}) the controller will re-enable the Phase drive for a defined period (t_{on}) in an attempt to re-start the fan. This cycle of (t_{off}) and (t_{on}) will be repeated indefinitely or until the fan re-starts.

The frequency at which this takes place is determined by the value of the capacitor applied to this CLCK pin. For a 12V supply a value of 1uF will typically provide an 'On' (drive) period of 0.56s and an 'Off' (wait) period of 6.8s, giving an On:Off ratio of 1:12.

The CLCK timing periods are determined by the following equations:

$$t_{lock} = \frac{V_{THH} \times C_{LCK}}{I_{LCKC}}$$

$$t_{on} = \frac{(V_{THH} - V_{THL}) \times C_{LCK}}{I_{LCKC}}$$

$$t_{off} = \frac{(V_{THH} - V_{THL}) \times C_{LCK}}{I_{LCKD}}$$

Where: V_{THH} and V_{THL} are the CLCK pin threshold voltages and I_{LCKC} and I_{LCKD} are the charge and discharge currents.

As these threshold voltages are nominally set to $V_{THH} = 3V$ and $V_{THL} = 1V$ the equations can be simplified as follows:

$$t_{lock} = \frac{3 \times C_{LCK}}{I_{LCKC}} \quad t_{on} = \frac{2 \times C_{LCK}}{I_{LCKC}}$$

$$t_{off} = \frac{2 \times C_{LCK}}{I_{LCKD}}$$

GND - Ground

This is the device supply ground return pin and will generally be the most negative supply pin to the fan.

RD - Locked Rotor Error Output

This pin is the Locked Rotor output as referred to in the CLCK timing section above. It is high when the rotor is stopped and low when it is running.

This is an open collector drive giving an active pull down with the high level being provided by an external pull up resistor.

FG - Frequency Generator (speed)

This is the Frequency Generator output and is a buffered signal from the Hall sensor.

This is an open collector drive giving an active pull down with the high level being provided by an external pull up resistor.

Ph1Lo & Ph2Lo - Low-side External H-bridge Driver

These pair of outputs drive the Low side of the external high power H-bridge devices that in turn drives the single phase winding. These outputs provide both the commutation and PWM waveforms. The outputs are of the Darlington emitter follower type with an active pull-down to help faster switch off when using bipolar devices or MOSFET devices with a high gate capacitance. When in the high state the outputs will provide up to 80mA of drive into the base or gates of external transistors as shown in the Typical Application circuit following.

When in the low state the active Phase drive is capable of sinking up to 32mA when driving low to aid turn off times during PWM operation. When the Phase is inactive the output is held low by a 7.5k Ω internal pull-down resistor.

Ph1Hi & Ph2Hi - High-side External H-bridge Driver

These are the High side outputs to the external H-bridge and are open collector outputs capable of sinking 100mA. This signal provides commutation only to the H-bridge.

V+OP- Phase Outputs supply voltage

This pin is the supply to the Phase outputs and will be connected differently dependant upon external transistor type.

For bipolar devices this pin will be connected via a resistor to the VCC pin. The resistor is used to control the current into the transistor base so its value is chosen accordingly.

For MOSFET devices the pin will connect directly to the VCC pin

ZXBM1017

VCC - Applied Voltage

This is the device internal circuitry supply voltage. For 5V to 12V fans this can be supplied directly from the Fan Motor supply. For fans likely to run in excess of the 18V maximum rating for the device this will be supplied from an external regulator such as a Zener diode.

SetTh - Set Threshold Voltage

The ZXBM1015 contains a current monitor circuit used to sense the current flowing in the motor winding and this pin is used to control how the circuit responds to that current.

The device works in a threshold feedback mode using a potential divider to the Set Threshold pin. This potential divider is used to set a voltage that will be compared with the voltage generated by the current in a Sense resistor attached in the Low-Side ground return of the external H-Bridge driver. When the current in the Sense resistor, and thus the voltage, rises above the SetTh pin threshold the controller will back-off the PWM drive to limit the maximum current taken by the motor. To do this the current monitor will internally apply a correction signal to the SPD pin. If the motor current is below the set threshold the controller does not influence the SPD voltage. A suitable voltage range for the SetTh pin, and thus the sensed voltage on the Sense pin, would be 50mV to 200mV.

It should be noted that the effectiveness of the control is determined by the external network used to control the SPD pin. It will not work where the fan is being controlled by a low source impedance voltage. If the fan is being controlled from an external voltage source then a resistor $>1k\Omega$ should be placed in series with the SPD pin.

The minimum speed setting on the SMIN pin will override the current limit feature. A current cannot be set that is lower than the current taken when the motor stalls at minimum speed.

Sense

This pin is used by the current sensing circuit, as described above, to monitor the current taken by the motor windings. The signal comes from a sense resistor in the Low-Side ground return of the external H-Bridge driver.

ZXBM1017

NOTES:

ZXBM1017

NOTES:

ZXBM1017

NOTES:

ZXBM1017

PACKAGE OUTLINE - TSSOP20

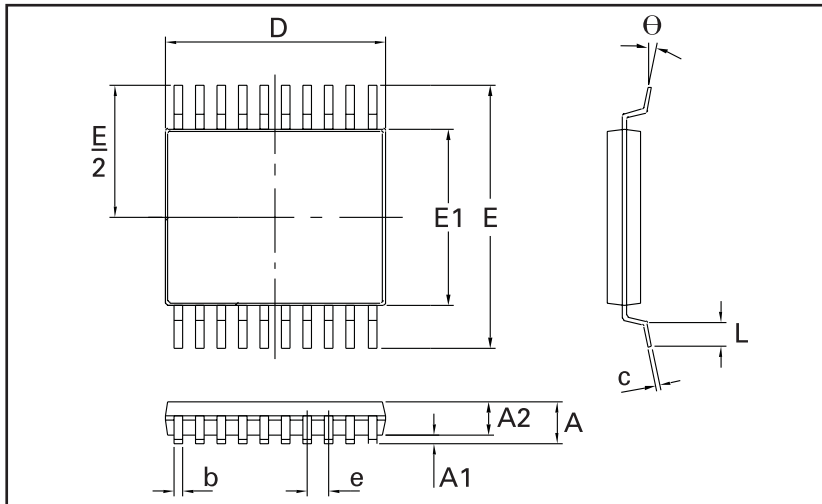

Controlling dimensions are in millimeters, approximate dimensions are given inches.

Conforms to JEDEC MO-153 AC

PACKAGE DIMENSIONS

DIM	Millimeters		Inches		DIM	Millimeters		Inches	
	Min	Max	Min	Max		Min	Max	Min	Max
A	-	1.20	-	0.047	L	0.45	0.75	0.018	0.030
A1	0.05	0.15	0.002	0.006	e	0.65 BSC		0.026 BSC	
A2	0.80	1.05	0.031	0.041	b	0.19	0.30	0.007	0.012
D	6.4	6.6	0.252	0.260	c	0.09	0.20	0.004	0.008
E	6.40 BSC		0.252 BSC		Θ	0°	8°	0°	8°
E1	4.3	4.5	0.169	0.177	-	-	-	-	-

© Zetex Semiconductors plc 2005

Europe	Americas	Asia Pacific	Corporate Headquarters
Zetex GmbH Streitfeldstraße 19 D-81673 München Germany	Zetex Inc 700 Veterans Memorial Hwy Hauppauge, NY 11788 USA	Zetex (Asia) Ltd 3701-04 Metroplaza Tower 1 Hing Fong Road, Kwai Fong Hong Kong	Zetex Semiconductors plc Zetex Technology Park Chadderton, Oldham, OL9 9LL United Kingdom
Telefon: (49) 89 45 49 49 0 Fax: (49) 89 45 49 49 49 europa.sales@zetex.com	Telephone: (1) 631 360 2222 Fax: (1) 631 360 8222 usa.sales@zetex.com	Telephone: (852) 26100 611 Fax: (852) 24250 494 asia.sales@zetex.com	Telephone (44) 161 622 4444 Fax: (44) 161 622 4446 hq@zetex.com

These offices are supported by agents and distributors in major countries world-wide.

This publication is issued to provide outline information only which (unless agreed by the Company in writing) may not be used, applied or reproduced for any purpose or form part of any order or contract or be regarded as a representation relating to the products or services concerned. The Company reserves the right to alter without notice the specification, design, price or conditions of supply of any product or service.

For the latest product information, log on to www.zetex.com



ISSUE 2 - OCTOBER 2005