

### Typical Applications

The HMC478SC70(E) is an ideal for:

- Cellular / PCS / 3G
- WiBro / WiMAX / 4G
- Fixed Wireless & WLAN
- CATV, Cable Modem & DBS
- Microwave Radio & Test Equipment

### Features

- P1dB Output Power: +17 dBm
- Gain: 23 dB
- Output IP3: +31 dBm
- Cascadable 50 Ohm I/Os
- Single Supply: +5V to +8V
- Industry Standard SC70 Package

### Functional Diagram

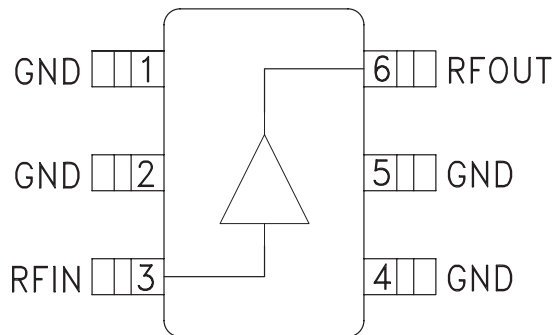

### General Description

The HMC478SC70(E) is a SiGe Heterojunction Bipolar Transistor (HBT) Gain Block MMIC SMT amplifier covering DC to 4 GHz. This industry standard SC70 packaged amplifier can be used as a cascadable 50 Ohm RF/IF gain stage as well as a LO or PA driver with up to +17 dBm output power. The HMC478SC70(E) offers 23 dB of gain with a +31 dBm output IP3 at 850 MHz while requiring only 62 mA from a single positive supply. The Darlington topology results in reduced sensitivity to normal process variations and excellent gain stability over temperature while requiring a minimal number of external bias components.

### Electrical Specifications, $V_s = 5V$ , $R_{bias} = 18 \text{ Ohm}$ , $T_A = +25^\circ \text{ C}$

Parameter		Min.	Typ.	Max.	Units
Gain	DC - 1.0 GHz	20	24		dB
	1.0 - 2.0 GHz	16	20		dB
	2.0 - 3.0 GHz	13	17		dB
	3.0 - 4.0 GHz	11	15		dB
Gain Variation Over Temperature	DC - 4.0 GHz		0.015	0.02	dB/ °C
Input Return Loss	DC - 3.0 GHz		15		dB
	3.0 - 4.0 GHz		17		dB
Output Return Loss	DC - 3.0 GHz		15		dB
	3.0 - 4.0 GHz		13		dB
Reverse Isolation	DC - 4.0 GHz		20		dB
Output Power for 1 dB Compression (P1dB)	0.5 - 2.0 GHz	13	16		dBm
	2.0 - 3.0 GHz	11	15		dBm
	3.0 - 4.0 GHz	9	12		dBm
Output Third Order Intercept (IP3) ( $P_{out} = 0 \text{ dBm}$ per tone, 1 MHz spacing)	0.5 - 2.0 GHz		31		dBm
	2.0 - 3.0 GHz		28		dBm
	3.0 - 4.0 GHz		25		dBm
Noise Figure	DC - 3.0 GHz		2.5		dB
	3.0 - 4.0 GHz		2.8		dB
Supply Current ( $I_{cc}$ )			62	82	mA

**Broadband Gain & Return Loss**

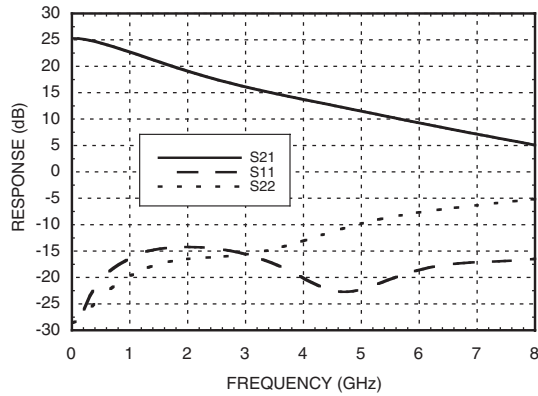

**Gain vs. Temperature**

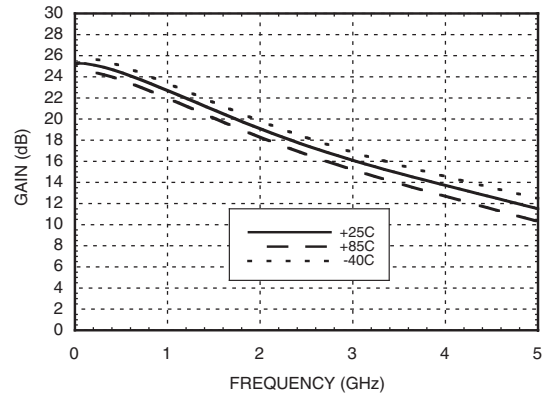

**Input Return Loss vs. Temperature**

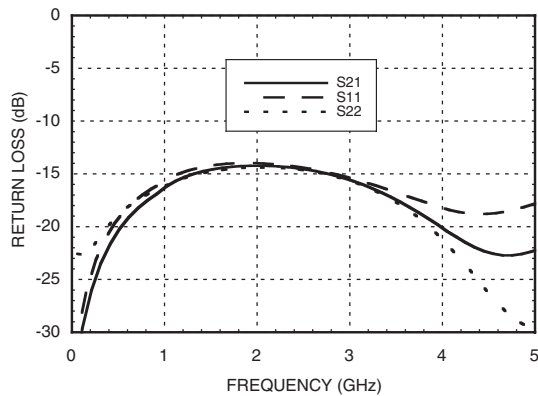

**Output Return Loss vs. Temperature**

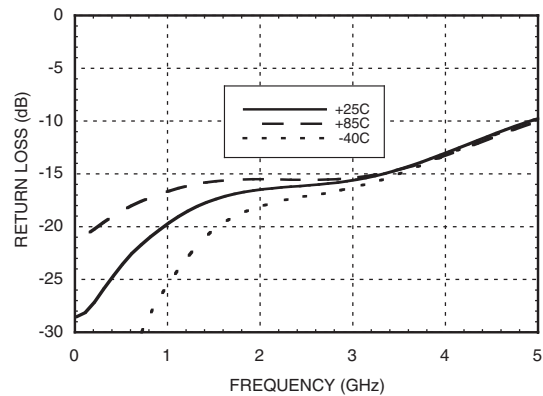

**Reverse Isolation vs. Temperature**

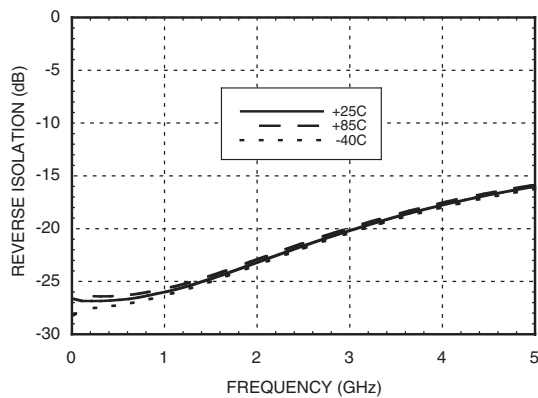

**Noise Figure vs. Temperature**

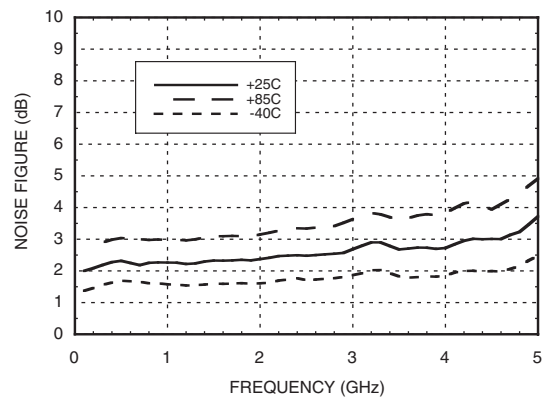

**P1dB vs. Temperature**

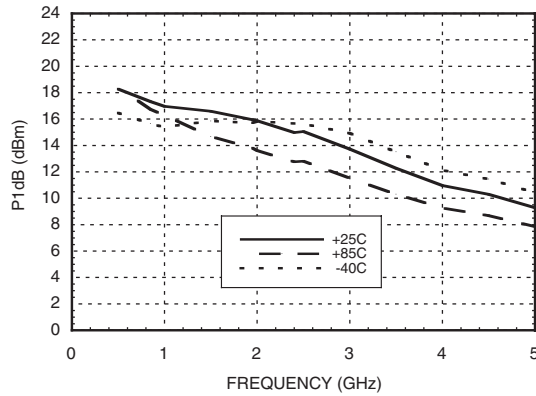

**Psat vs. Temperature**

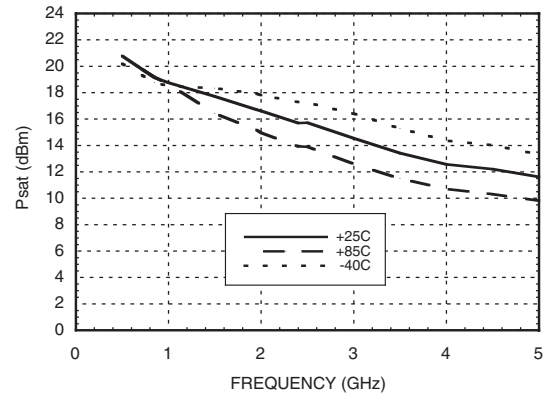

**Output IP3 vs. Temperature**

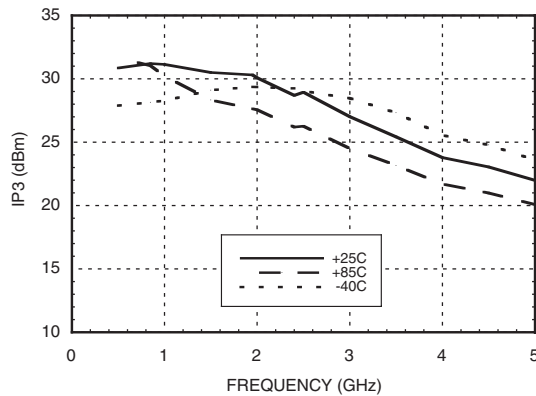

**Gain, Power & OIP3 vs. Supply Voltage  
for Rs = 18 Ohms @ 850 MHz**

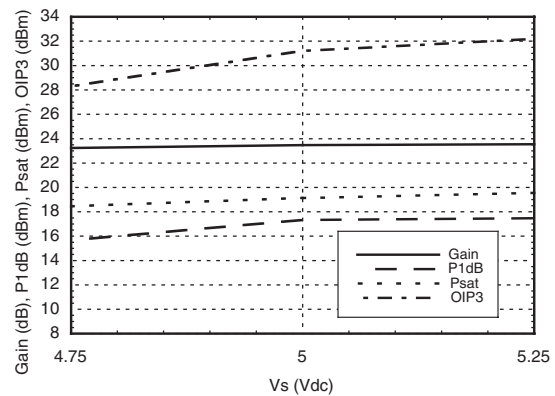

**Icc vs. Vcc Over Temperature for  
Fixed Vs= 5V, RBIAS= 18 Ohms**

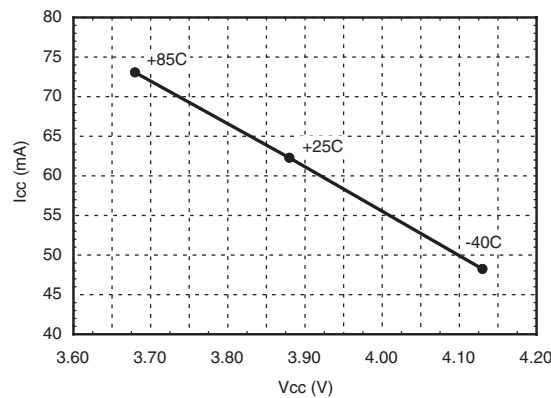

### Absolute Maximum Ratings

Collector Bias Voltage (Vcc)	+6.0 Vdc
Collector Bias Current (Icc)	100 mA
RF Input Power (RFIn)(Vcc = +2.4 Vdc)	+5 dBm
Junction Temperature	150 °C
Continuous P <sub>diss</sub> (T = 85 °C) (derate 9 mW/°C above 85 °C)	0.583 W
Thermal Resistance (junction to lead)	111.5 °C/W
Storage Temperature	-65 to +150 °C
Operating Temperature	-40 to +85 °C
ESD Sensitivity (HBM)	Class 1C



ELECTROSTATIC SENSITIVE DEVICE  
OBSERVE HANDLING PRECAUTIONS

### Outline Drawing

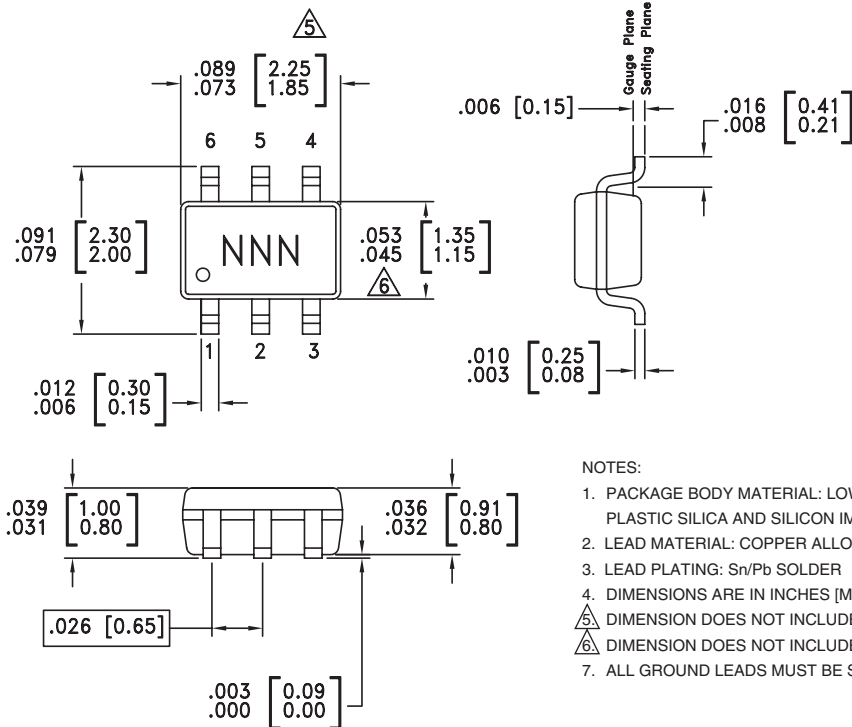

#### NOTES:

1. PACKAGE BODY MATERIAL: LOW STRESS INJECTION MOLDED PLASTIC SILICA AND SILICON IMPREGNATED.
2. LEAD MATERIAL: COPPER ALLOY
3. LEAD PLATING: Sn/Pb SOLDER
4. DIMENSIONS ARE IN INCHES [MILLIMETERS].
5. DIMENSION DOES NOT INCLUDE MOLDFLASH OF 0.15mm PER SIDE.
6. DIMENSION DOES NOT INCLUDE MOLDFLASH OF 0.25mm PER SIDE.
7. ALL GROUND LEADS MUST BE SOLDERED TO PCB RF GROUND.

### Package Information

Part Number	Package Body Material	Lead Finish	MSL Rating	Package Marking
HMC478SC70	Low Stress Injection Molded Plastic	Sn/Pb Solder	MSL1 <sup>[1]</sup>	478
HMC478SC70E	RoHS-compliant Low Stress Injection Molded Plastic	100% matte Sn	MSL1 <sup>[2]</sup>	478

[1] Max peak reflow temperature of 235 °C

[2] Max peak reflow temperature of 260 °C

### Pin Descriptions

Pin Number	Function	Description	Interface Schematic
1, 2, 4, 5	GND	These pins must be connected to RF/DC ground.	
3	RFIN	This pin is DC coupled. An off chip DC blocking capacitor is required.	
6	RFOUT	RF output and DC Bias (Vcc) for the output stage.	

### Application Circuit

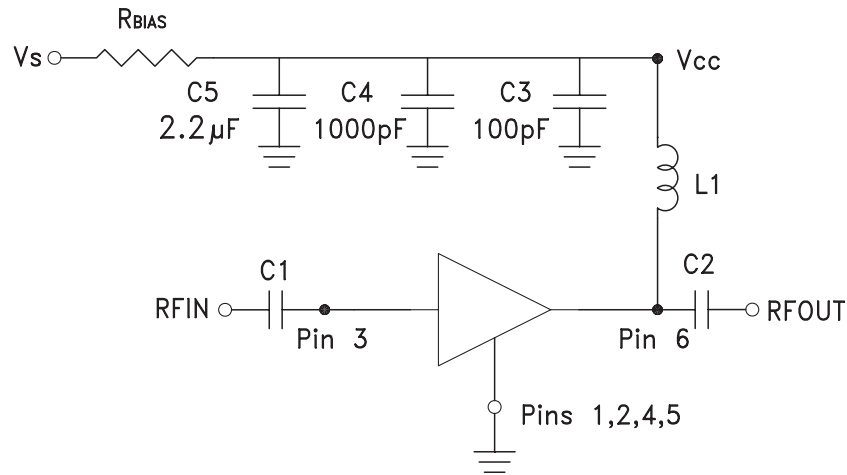

### Recommended Bias Resistor Values for $I_{cc} = 62 \text{ mA}$ , $R_{bias} = (V_s - V_{cc}) / I_{cc}$

Supply Voltage (Vs)	5V	6V	8V
RBIAS VALUE	18 Ω	35 Ω	67 Ω
RBIAS POWER RATING	1/8 W	1/4 W	1/2 W

Note:

- External blocking capacitors are required on RFIN and RFOUT.
- RBIAS provides DC bias stability over temperature.

### Recommended Component Values for Key Application Frequencies

Component	Frequency (MHz)					
	50	900	1900	2200	2400	3500
L1	270 nH	56 nH	18 nH	18 nH	15 nH	8.2 nH
C1, C2	0.01 μF	100 pF	100 pF	100 pF	100 pF	100 pF

**Evaluation PCB**

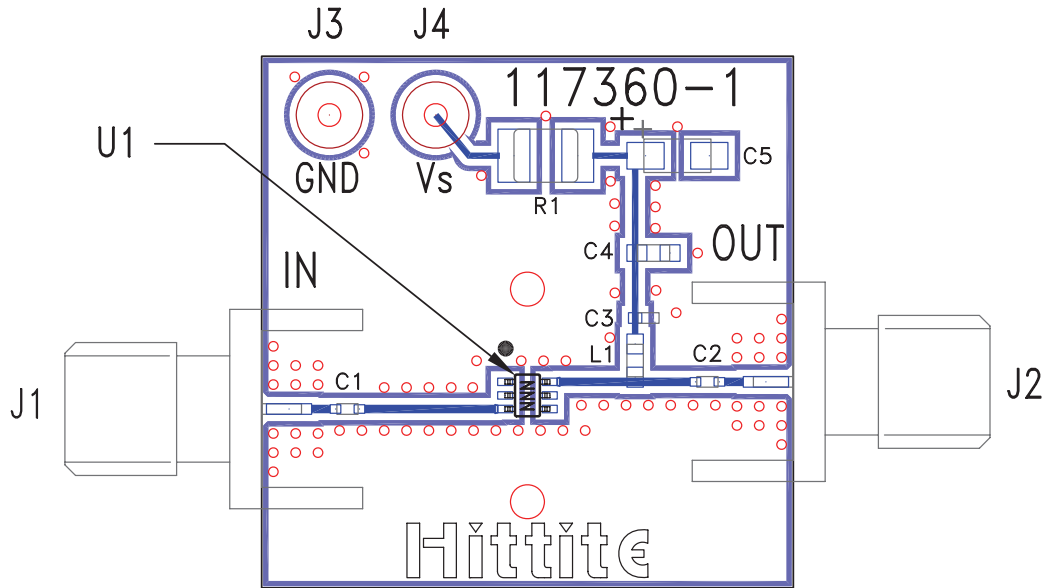

**List of Materials for Evaluation PCB 118039 [1]**

Item	Description
J1 - J2	PCB Mount SMA Connector
J3 - J4	DC Pin
C1 - C3	100 pF Capacitor, 0402 Pkg.
C4	1000 pF Capacitor, 0603 Pkg.
C5	2.2 $\mu$ F Capacitor, Tantalum
R1	18 Ohm Resistor, 1210 Pkg.
L1	18 nH Inductor, 0603 Pkg.
U1	HMC478SC70(E)
PCB [2]	117360 Evaluation PCB

[1] Reference this number when ordering complete evaluation PCB

[2] Circuit Board Material: Rogers 4350

The circuit board used in the final application should use RF circuit design techniques. Signal lines should have 50 ohm impedance while the package ground leads should be connected directly to the ground plane similar to that shown. A sufficient number of via holes should be used to connect the top and bottom ground planes. The evaluation board should be mounted to an appropriate heat sink. The evaluation circuit board shown is available from Hittite upon request.