

IRFP17N50LPbF

SMPS MOSFET

HEXFET® Power MOSFET

Applications

- Zero Voltage Switching SMPS
- Telecom and Server Power Supplies
- Uninterruptible Power Supplies
- Motor Control applications
- Lead-Free

V_{DSS}	$R_{DS(on)}$ typ.	T_{rr} typ.	I_D
500V	0.28Ω	170ns	16A

Features and Benefits

- SuperFast body diode eliminates the need for external diodes in ZVS applications.
- Lower Gate charge results in simpler drive requirements.
- Enhanced dv/dt capabilities offer improved ruggedness.
- Higher Gate voltage threshold offers improved noise immunity.

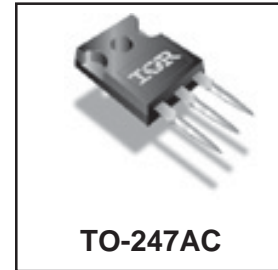

Absolute Maximum Ratings

	Parameter	Max.	Units
I_D @ $T_C = 25^\circ\text{C}$	Continuous Drain Current, V_{GS} @ 10V	16	A
I_D @ $T_C = 100^\circ\text{C}$	Continuous Drain Current, V_{GS} @ 10V	11	
I_{DM}	Pulsed Drain Current ①	64	
P_D @ $T_C = 25^\circ\text{C}$	Power Dissipation	220	W
	Linear Derating Factor	1.8	W/°C
V_{GS}	Gate-to-Source Voltage	± 30	V
dv/dt	Peak Diode Recovery dv/dt ②	13	V/ns
T_J T_{STG}	Operating Junction and Storage Temperature Range	-55 to + 150	°C
	Soldering Temperature, for 10 seconds	300 (1.6mm from case)	
	Mounting torque, 6-32 or M3 screw	10lb·in (1.1N·m)	

Diode Characteristics

Symbol	Parameter	Min.	Typ.	Max.	Units	Conditions
I_S	Continuous Source Current (Body Diode)	—	—	16	A	MOSFET symbol showing the integral reverse p-n junction diode.
I_{SM}	Pulsed Source Current (Body Diode) ①	—	—	64		
V_{SD}	Diode Forward Voltage	—	—	1.5	V	
t_{rr}	Reverse Recovery Time	—	170	250	ns	$T_J = 25^\circ\text{C}$, $I_F = 16\text{A}$
		—	220	330		$T_J = 125^\circ\text{C}$, $di/dt = 100\text{A}/\mu\text{s}$ ④
Q_{rr}	Reverse Recovery Charge	—	470	710	nC	$T_J = 25^\circ\text{C}$, $I_S = 16\text{A}$, $V_{GS} = 0\text{V}$ ④
		—	810	1210		$T_J = 125^\circ\text{C}$, $di/dt = 100\text{A}/\mu\text{s}$ ④
I_{RRM}	Reverse Recovery Current	—	7.3	11	A	$T_J = 25^\circ\text{C}$
t_{on}	Forward Turn-On Time	Intrinsic turn-on time is negligible (turn-on is dominated by LS+LD)				

IRFP17N50LPbF

International
IR Rectifier

Static @ $T_J = 25^\circ\text{C}$ (unless otherwise specified)

Symbol	Parameter	Min.	Typ.	Max.	Units	Conditions
$V_{(BR)DSS}$	Drain-to-Source Breakdown Voltage	500	—	—	V	$V_{GS} = 0V, I_D = 250\mu A$
$\Delta V_{(BR)DSS}/\Delta T_J$	Breakdown Voltage Temp. Coefficient	—	0.60	—	V/°C	Reference to $25^\circ\text{C}, I_D = 1\text{mA}$
$R_{DS(on)}$	Static Drain-to-Source On-Resistance	—	0.28	0.32	Ω	$V_{GS} = 10V, I_D = 9.9A$ ④
$V_{GS(th)}$	Gate Threshold Voltage	3.0	—	5.0	V	$V_{DS} = V_{GS}, I_D = 250\mu A$
I_{DSS}	Drain-to-Source Leakage Current	—	—	50	μA	$V_{DS} = 500V, V_{GS} = 0V$
		—	—	2.0	mA	$V_{DS} = 400V, V_{GS} = 0V, T_J = 125^\circ\text{C}$
I_{GSS}	Gate-to-Source Forward Leakage	—	—	100	nA	$V_{GS} = 30V$
	Gate-to-Source Reverse Leakage	—	—	-100	nA	$V_{GS} = -30V$
R_G	Internal Gate Resistance	—	1.4	—	Ω	$f = 1\text{MHz}, \text{open drain}$

Dynamic @ $T_J = 25^\circ\text{C}$ (unless otherwise specified)

Symbol	Parameter	Min.	Typ.	Max.	Units	Conditions
g_{fs}	Forward Transconductance	11	—	—	S	$V_{DS} = 50V, I_D = 9.9A$
Q_g	Total Gate Charge	—	—	130	nC	$I_D = 16A$ $V_{DS} = 400V$ $V_{GS} = 10V, \text{See Fig. 7 \& 15 } \text{ ④}$
Q_{gs}	Gate-to-Source Charge	—	—	33		
Q_{gd}	Gate-to-Drain ("Miller") Charge	—	—	59		
$t_{d(on)}$	Turn-On Delay Time	—	21	—	ns	$V_{DD} = 250V$ $I_D = 16A$ $R_G = 7.5\Omega$ $V_{GS} = 10V, \text{See Fig. 14a \& 14b } \text{ ④}$
t_r	Rise Time	—	51	—		
$t_{d(off)}$	Turn-Off Delay Time	—	50	—		
t_f	Fall Time	—	28	—		
C_{iss}	Input Capacitance	—	2760	—	pF	$V_{GS} = 0V$ $V_{DS} = 25V$ $f = 1.0\text{MHz}, \text{See Fig. 5}$ $V_{GS} = 0V, V_{DS} = 1.0V, f = 1.0\text{MHz}$ $V_{GS} = 0V, V_{DS} = 400V, f = 1.0\text{MHz}$ $V_{GS} = 0V, V_{DS} = 0V \text{ to } 400V \text{ ④}$
C_{oss}	Output Capacitance	—	325	—		
C_{rss}	Reverse Transfer Capacitance	—	37	—		
C_{oss}	Output Capacitance	—	3690	—		
C_{oss}	Output Capacitance	—	84	—		
$C_{oss \text{ eff.}}$	Effective Output Capacitance	—	159	—		
$C_{oss \text{ eff. (ER)}}$	Effective Output Capacitance (Energy Related)	—	120	—		

Avalanche Characteristics

Symbol	Parameter	Typ.	Max.	Units
E_{AS}	Single Pulse Avalanche Energy ④	—	390	mJ
I_{AR}	Avalanche Current ④	—	16	A
E_{AR}	Repetitive Avalanche Energy ④	—	22	mJ

Thermal Resistance

Symbol	Parameter	Typ.	Max.	Units
$R_{\theta JC}$	Junction-to-Case	—	0.56	°C/W
$R_{\theta CS}$	Case-to-Sink, Flat, Greased Surface	0.50	—	
$R_{\theta JA}$	Junction-to-Ambient	—	62	

Notes:

- ① Repetitive rating; pulse width limited by max. junction temperature. (See Fig. 11)
- ② Starting $T_J = 25^\circ\text{C}$, $L = 3.0\text{mH}$, $R_G = 25\Omega$, $I_{AS} = 16A$. (See Figure 12).
- ③ $I_{SD} = 16A$, $di/dt \leq 347A/\mu s$, $V_{DD} \leq V_{(BR)DSS}$, $T_J \leq 150^\circ\text{C}$.
- ④ Pulse width $\leq 300\mu s$; duty cycle $\leq 2\%$.
- ⑤ $C_{oss \text{ eff.}}$ is a fixed capacitance that gives the same charging time as C_{oss} while V_{DS} is rising from 0 to 80% V_{DSS} .
 $C_{oss \text{ eff. (ER)}}$ is a fixed capacitance that stores the same energy as C_{oss} while V_{DS} is rising from 0 to 80% V_{DSS} .

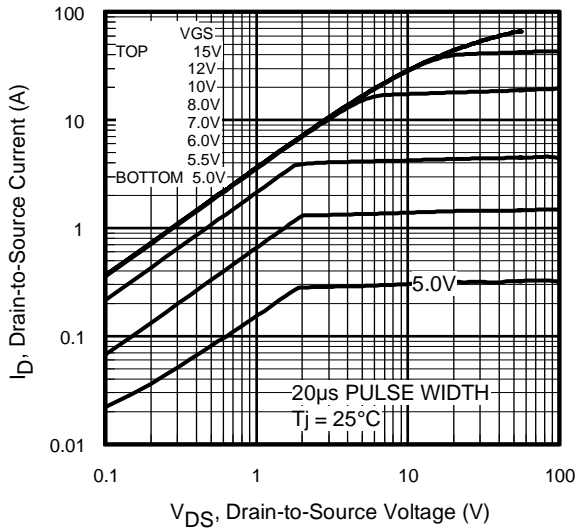

Fig 1. Typical Output Characteristics

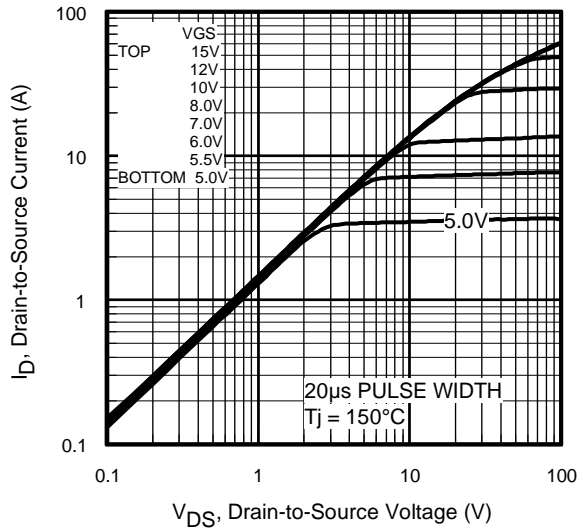

Fig 2. Typical Output Characteristics

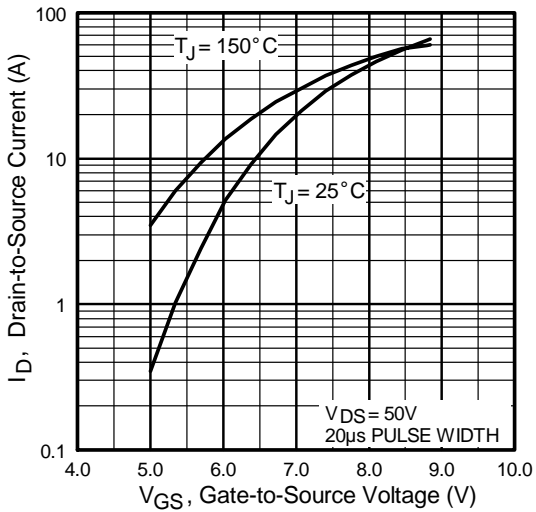

Fig 3. Typical Transfer Characteristics

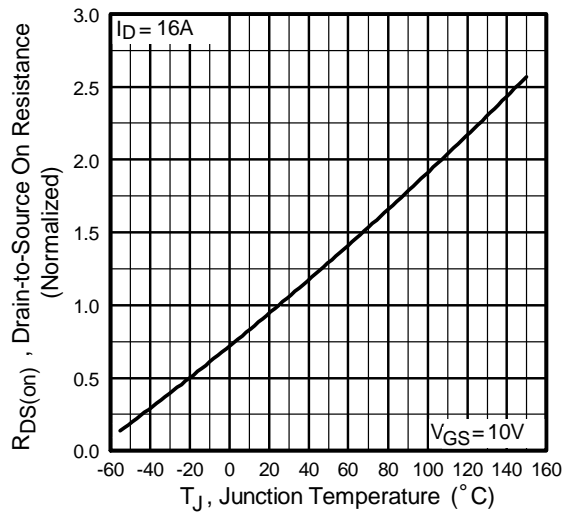

Fig 4. Normalized On-Resistance Vs. Temperature

IRFP17N50LPbF

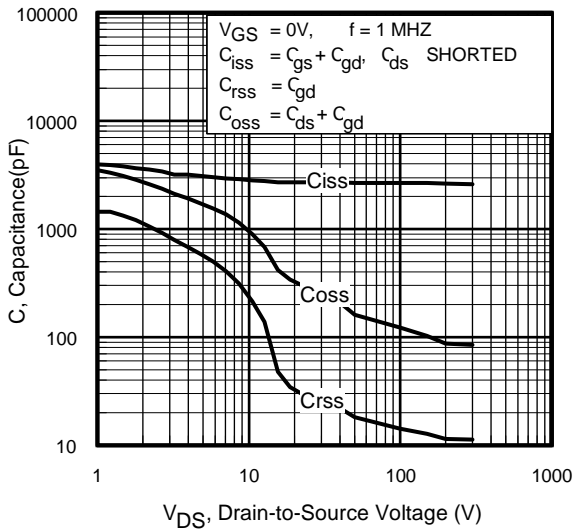

Fig 5. Typical Capacitance Vs. Drain-to-Source Voltage

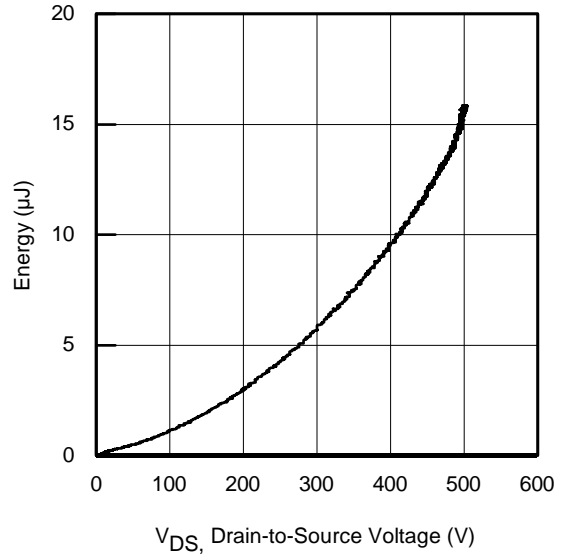

Fig 6. Typ. Output Capacitance Stored Energy vs. V_{DS}

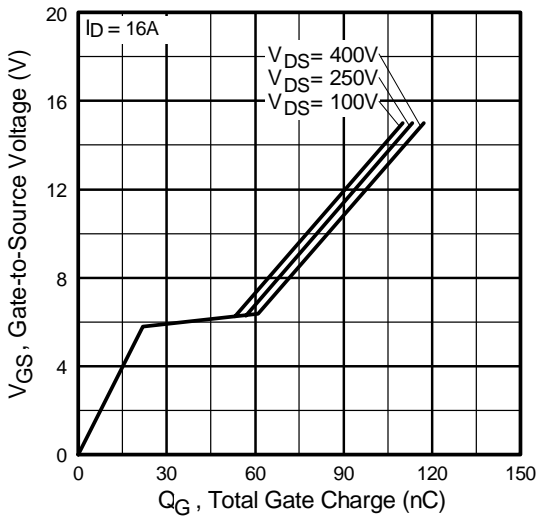

Fig 7. Typical Gate Charge Vs. Gate-to-Source Voltage

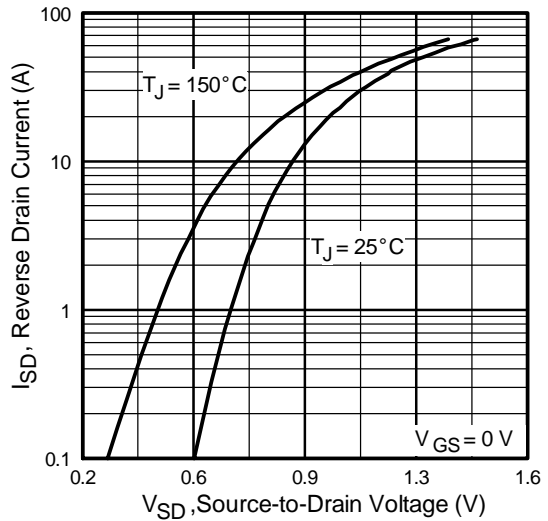

Fig 8. Typical Source-Drain Diode Forward Voltage

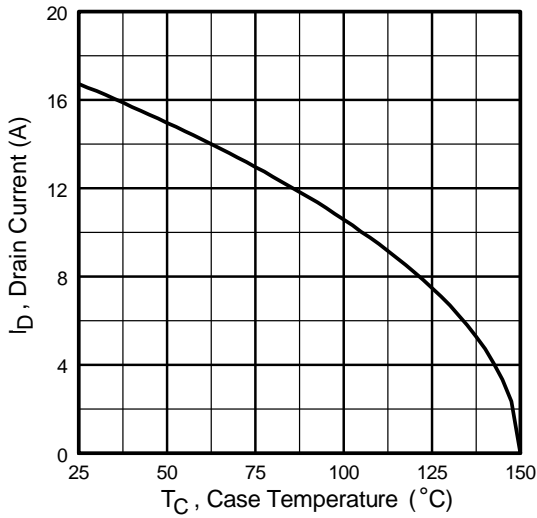

Fig 9. Maximum Drain Current Vs. Case Temperature

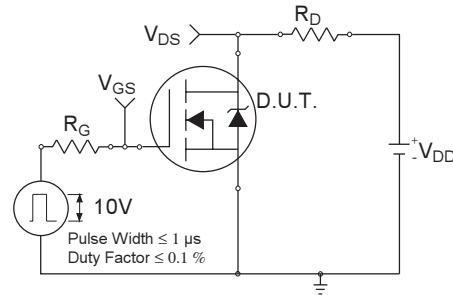

Fig 10a. Switching Time Test Circuit

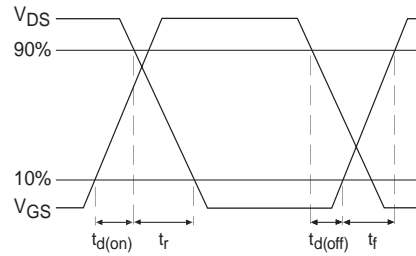

Fig 10b. Switching Time Waveforms

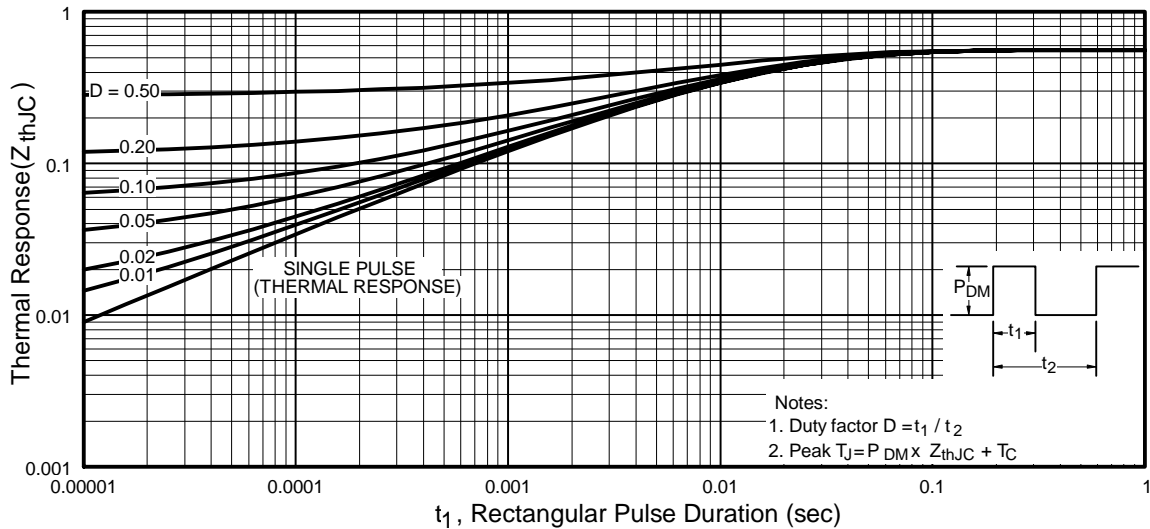

Fig 11. Maximum Effective Transient Thermal Impedance, Junction-to-Case

IRFP17N50LPbF

International
IR Rectifier

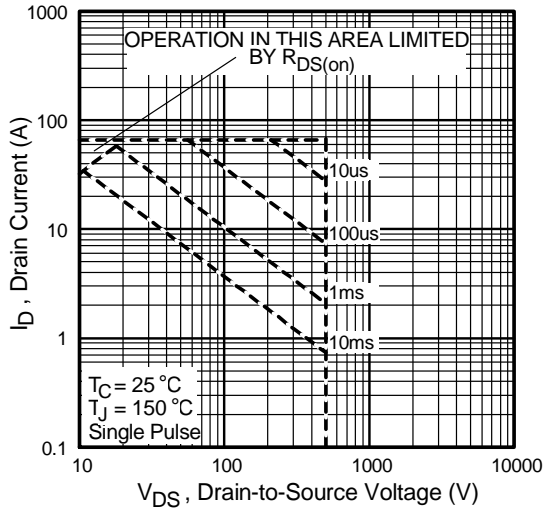

Fig 12. Maximum Safe Operating Area

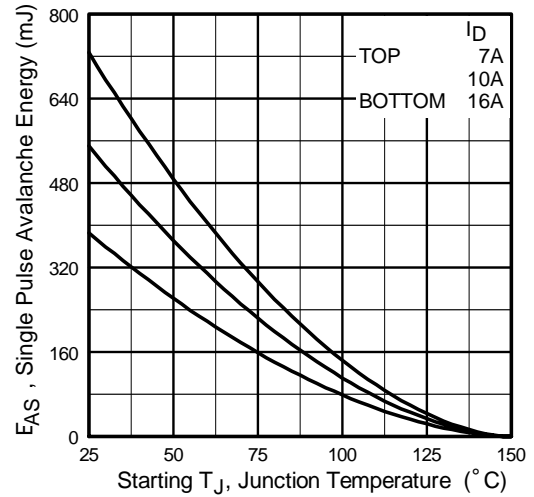

Fig 13. Maximum Avalanche Energy vs. Drain Current

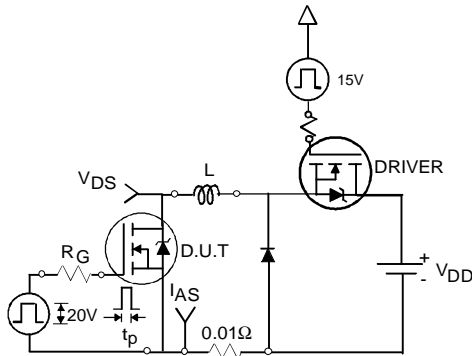

Fig 14a. Unclamped Inductive Test Circuit

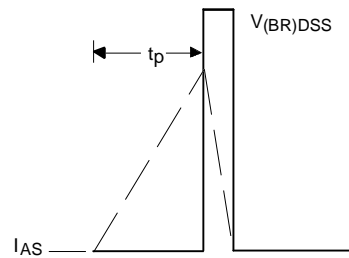

Fig 14b. Unclamped Inductive Waveforms

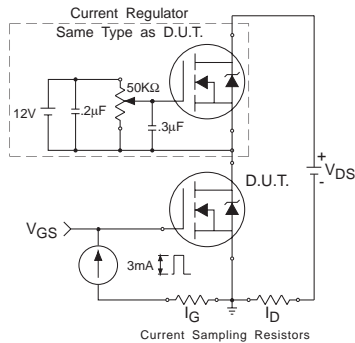

Fig 15a. Gate Charge Test Circuit

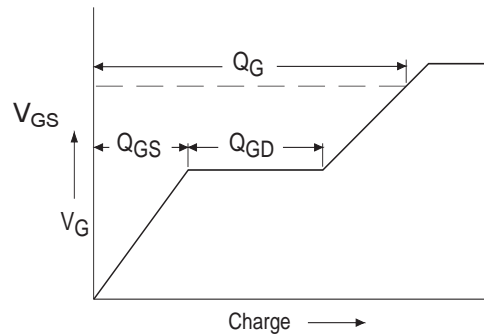
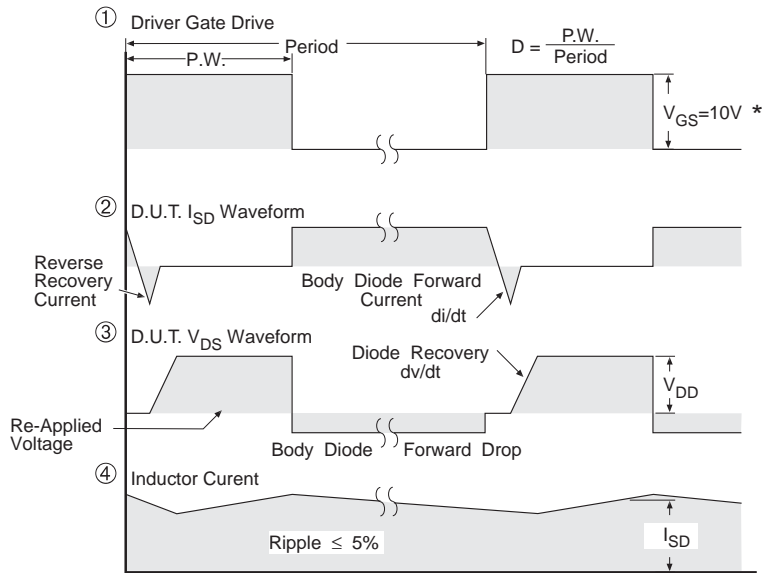
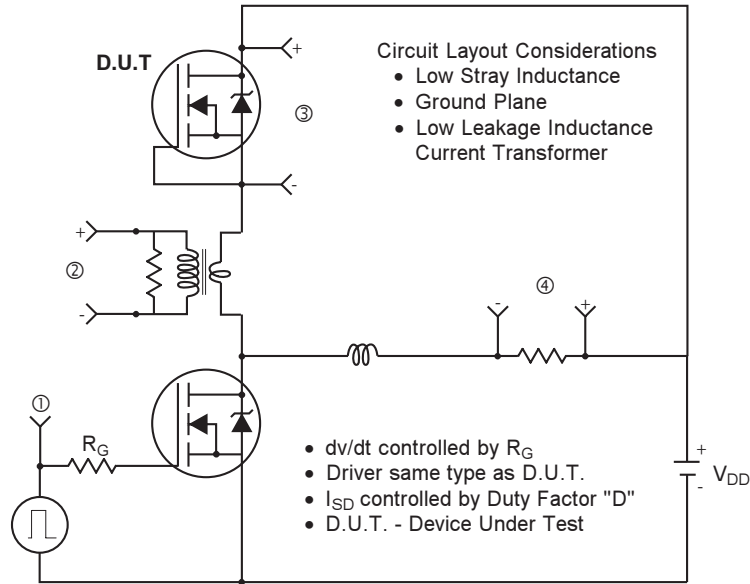

Fig 15b. Basic Gate Charge Waveform
www.irf.com

Peak Diode Recovery dv/dt Test Circuit



* $V_{GS} = 5V$ for Logic Level Devices

Fig 16. For N-Channel HEXFET® Power MOSFETs

IRFP17N50LPbF

International
IR Rectifier

TO-247AC Package Outline Dimensions are shown in millimeters (inches)

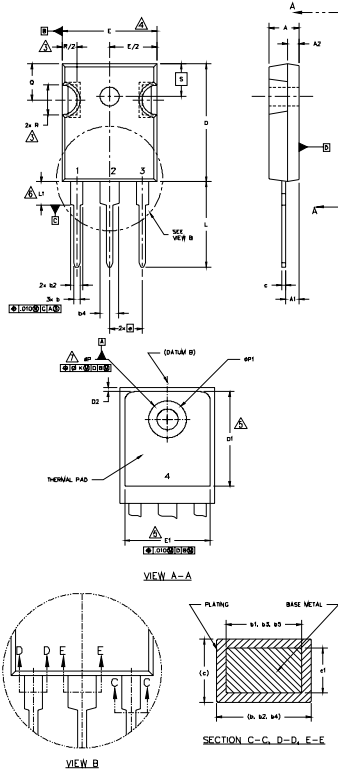

NOTES:

- DIMENSIONING AND TOLERANCING PER ASME Y14.5M 1994.
- DIMENSIONS ARE SHOWN IN INCHES [MILLIMETERS]
- CONTOUR OF SLOT OPTIONAL.
- DIMENSION D & E DO NOT INCLUDE MOLD FLASH. MOLD FLASH SHALL NOT EXCEED .005" (0.127) PER SIDE. THESE DIMENSIONS ARE MEASURED AT THE OUTERMOST EXTREMES OF THE PLASTIC BODY.
- THERMAL PAD CONTOUR OPTIONAL WITHIN DIMENSIONS D1 & E1.
- LEAD FINISH UNCONTROLLED IN L1.
- ØP TO HAVE A MAXIMUM DRAFT ANGLE OF 1.5° TO THE TOP OF THE PART WITH A MAXIMUM HOLE DIAMETER OF .154" [3.91].
- OUTLINE CONFORMS TO JEDEC OUTLINE TO-247 WITH THE EXCEPTION OF DIMENSION c.

SYMBOL	DIMENSIONS				NOTES
	INCHES		MILLIMETERS		
A	.183	.209	4.65	5.31	
A1	.087	.102	2.21	2.59	
A2	.059	.098	1.50	2.49	
b	.039	.055	0.99	1.40	
b1	.039	.053	0.99	1.35	
b2	.065	.094	1.65	2.39	
b3	.065	.092	1.65	2.37	
b4	.102	.135	2.59	3.43	
b5	.102	.133	2.59	3.38	
c	.015	.034	0.38	0.86	
c1	.015	.030	0.38	0.76	
D	.776	.815	19.71	20.70	4
D1	.515	-	13.08	-	
D2	.020	.030	0.51	0.76	
E	.602	.625	15.29	15.87	4
E1	.540	-	13.72	-	
Ø	.215 BSC		5.46 BSC		
Øk	.010		2.54		
L	.559	.634	14.20	16.10	
L1	.146	.169	3.71	4.29	
N	3		7.62 BSC		
ØP	.140	.144	3.56	3.66	
ØP1	-	.275	-	6.98	
Q	.209	.224	5.31	5.69	
R	.178	.216	4.52	5.49	
S	.217 BSC		5.51 BSC		

LEAD ASSIGNMENTS

HEXFET

- GATE
- DRAIN
- SOURCE
- DRAIN

IGBTs, CoPACK

- GATE
- COLLECTOR
- EMITTER
- COLLECTOR

DIODES

- ANODE/OPEN
- CATHODE
- ANODE

TO-247AC Part Marking Information

EXAMPLE: THIS IS AN IRFPE30
WITH ASSEMBLY
LOT CODE 5657
ASSEMBLED ON WW 35, 2000
IN THE ASSEMBLY LINE "H"

Note: "P" in assembly line
position indicates "Lead-Free"

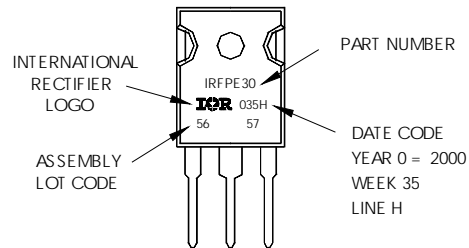

Data and specifications subject to change without notice.
This product has been designed and qualified for the Automotive [Q101] market.
Qualification Standards can be found on IR's Web site.

International
IR Rectifier

IR WORLD HEADQUARTERS: 233 Kansas St., El Segundo, California 90245, USA Tel: (310) 252-7105
TAC Fax: (310) 252-7903

Visit us at www.irf.com for sales contact information.07/04

www.irf.com