

ULTRA LOW CAPACITANCE SINGLE TVS FOR HIGH SPEED DATA LINES

This Transient Voltage Suppressor is intended to Protect Sensitive Equipment against Electrostatic Discharge and Transient Events as well to offer a Minimum insertion loss in high speed data communication transmission line ports used in Portable Consumer, Computing and Networking Applications.

SPECIFICATION FEATURES

- Working Peak Reverse Voltage Range - 5, 12, 15 and 24V
- Maximum Leakage Current of 5 μ A
- IEC61000-4-2 Compliance 15kV Air, 8kV Contact Discharge
- IEC61000-4-5 17 Amps peak, 8/20 μ s Waveform
- 100% Tin Matte Finish (RoHS Compliant)

APPLICATIONS

- Mobile Phones and accessories
- Universal Serial Bus (USB1.1 and 2.0) Applications
- Portable Consumer Electronics
- Instrumentation Equipment
- Ethernet 10, 100 and 1000 Base Port Protection

MAXIMUM RATINGS

Rating	Symbol	Value	Units
Peak Pulse Power 8/20 μ s Waveform	P _{pp}	400	W
Peak Pulse Current 8/20 μ s Waveform	I _{pp}	17	A
ESD Voltage (HBM)	V _{ESD}	>25	kV
Operating Temperature Range	T _J	-55 to +125	°C
Storage Temperature Range	T _{stg}	-55 to +150	°C
Lead Soldering Temperature (max 10 secs)	T _L	260	°C

ELECTRICAL CHARACTERISTICS T_j = 25°C

PJSLC05

Parameter	Symbol	Conditions	Min	Typical	Max	Units
Reverse Stand-Off Voltage	V _{WRM}				5	V
Reverse Breakdown Voltage	V _{BR}	I _{BR} = 1mA	6			V
Reverse Leakage Current	I _R	V _R = 5V			5	μ A
Clamping Voltage (8/20 μ s)	V _C	I _{pp} = 1 Amps			9.5	V
Clamping Voltage (8/20 μ s)	V _C	I _{pp} = 5 Amps			12	V
Maximum Peak Pulse Current	I _{pp}	8/20 μ s Waveform			17	A
Off State Junction Capacitance	C _j	0 Vdc Bias f = 1MHz Between pins 1 and 2			1.2	pF

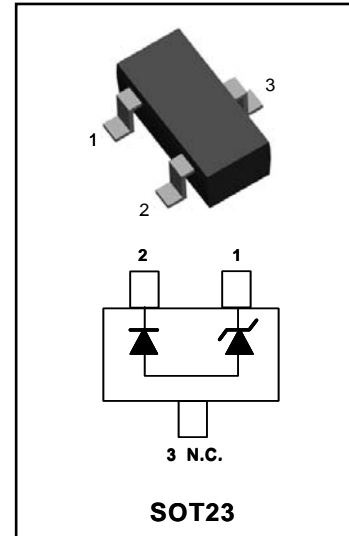

Device	Marking Code
PJSLC05	T1S
PJSLC12	S12
PJSLC15	S15
PJSLC24	S24

ELECTRICAL CHARACTERISTICS $T_j = 25^\circ\text{C}$
PJSLC12

Parameter	Symbol	Conditions	Min	Typical	Max	Units
Reverse Stand-Off Voltage	V_{WRM}				12	V
Reverse Breakdown Voltage	V_{BR}	$I_{BR} = 1 \text{ mA}$	13.3			V
Reverse Leakage Current	I_R	$V_R = 12\text{V}$			1	μA
Clamping Voltage (8/20 μs)	V_C	$I_{pp} = 1 \text{ Amps}$			19	V
Clamping Voltage (8/20 μs)	V_C	$I_{pp} = 5 \text{ Amps}$			24	V
Maximum Peak Pulse Current	I_{pp}	8/20 μs Waveform			12	A
Off State Junction Capacitance	C_j	0 Vdc Bias f = 1MHz Between pins 1 and 2			1.2	pF

PJSLC15

Parameter	Symbol	Conditions	Min	Typical	Max	Units
Reverse Stand-Off Voltage	V_{WRM}				15	V
Reverse Breakdown Voltage	V_{BR}	$I_{BR} = 1 \text{ mA}$	16.7			V
Reverse Leakage Current	I_R	$V_R = 15\text{V}$			1	μA
Clamping Voltage (8/20 μs)	V_C	$I_{pp} = 1 \text{ Amps}$			24	V
Clamping Voltage (8/20 μs)	V_C	$I_{pp} = 5 \text{ Amps}$			30	V
Maximum Peak Pulse Current	I_{pp}	8/20 μs Waveform			10	A
Off State Junction Capacitance	C_j	0 Vdc Bias f = 1MHz Between pins 1 and 2			1.2	pF

PJSLC24

Parameter	Symbol	Conditions	Min	Typical	Max	Units
Reverse Stand-Off Voltage	V_{WRM}				24	V
Reverse Breakdown Voltage	V_{BR}	$I_{BR} = 1 \text{ mA}$	26.7			V
Reverse Leakage Current	I_R	$V_R = 24\text{V}$			1	μA
Clamping Voltage (8/20 μs)	V_C	$I_{pp} = 1 \text{ Amps}$			43	V
Clamping Voltage (8/20 μs)	V_C	$I_{pp} = 5 \text{ Amps}$			55	V
Maximum Peak Pulse Current	I_{pp}	8/20 μs Waveform			5	A
Off State Junction Capacitance	C_j	0 Vdc Bias f = 1MHz Between pins 1 and 2			1.2	pF

TYPICAL CHARACTERISTIC CURVES

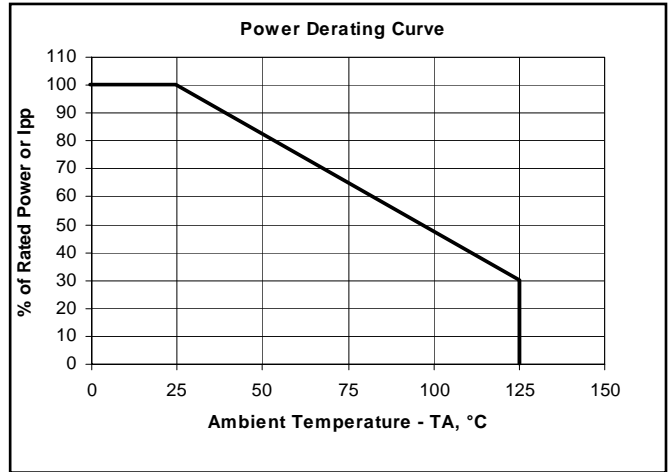
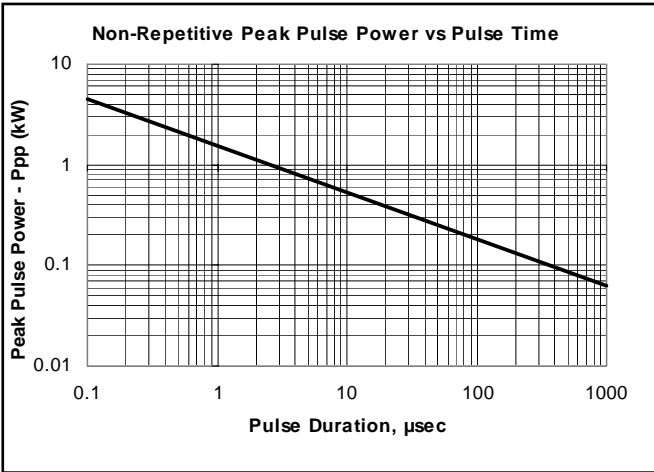
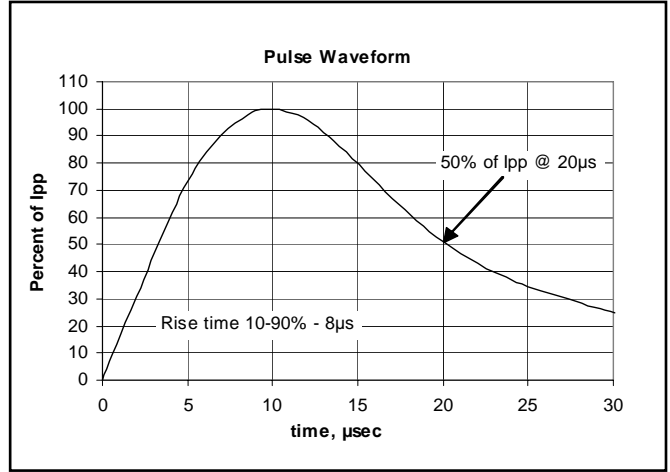
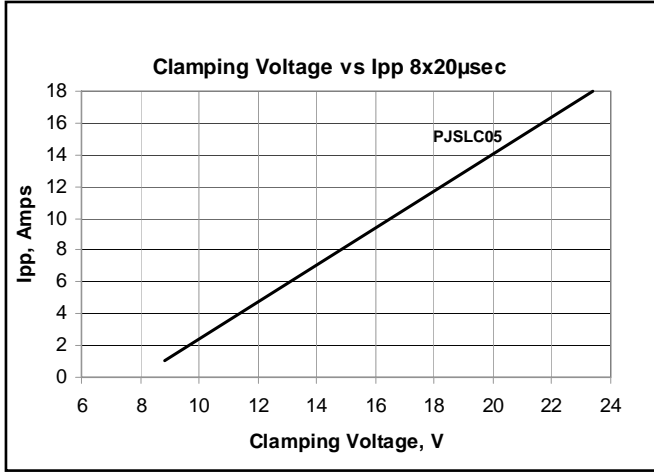

TYPICAL APPLICATION CONFIGURATIONS

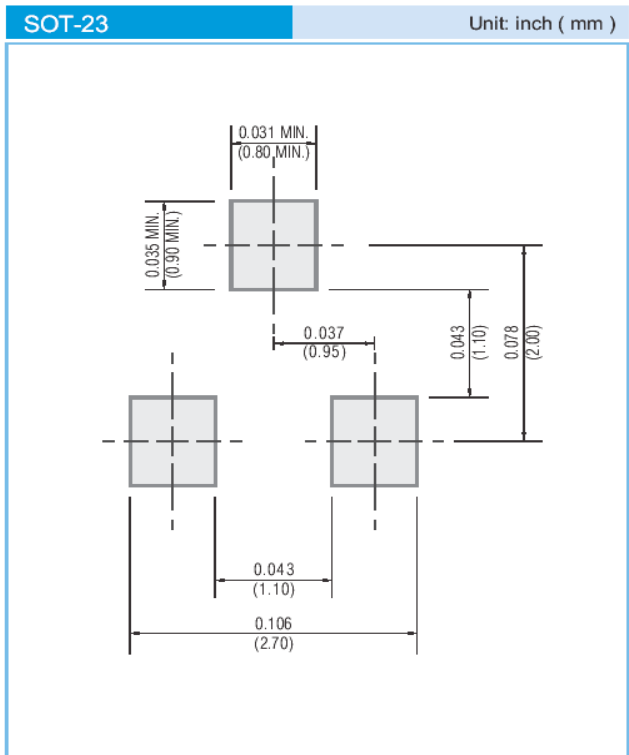
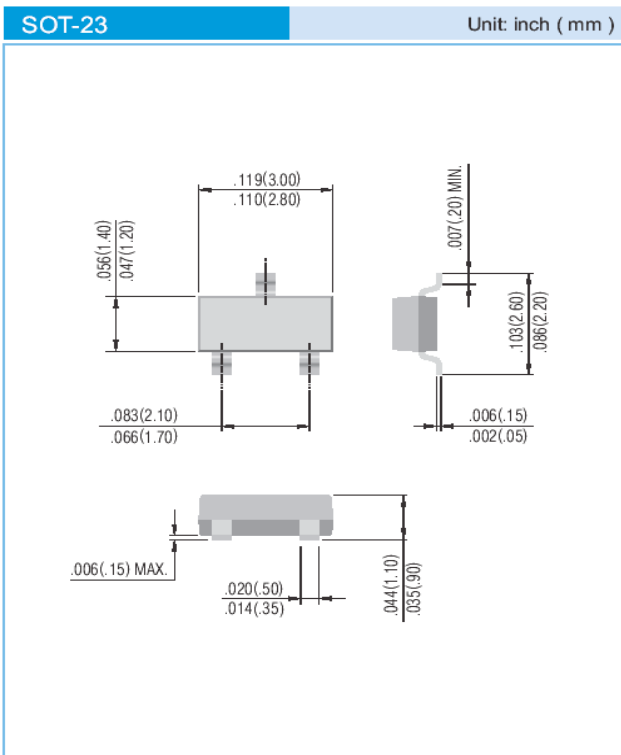
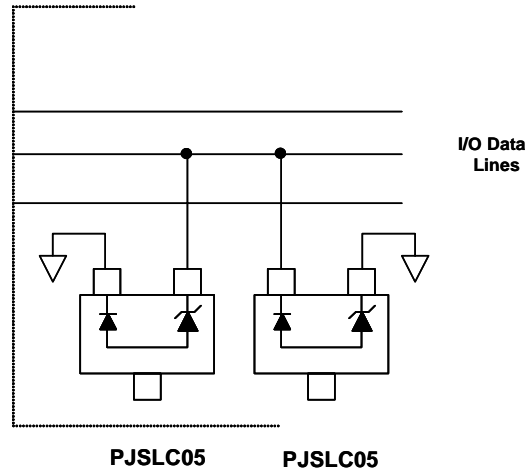
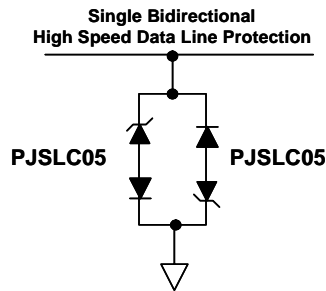
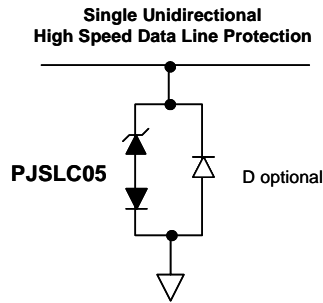

© Copyright PanJit International, Inc 2006

The information presented in this document is believed to be accurate and reliable. The specifications and information herein are subject to change without notice. Pan Jit makes no warranty, representation or guarantee regarding the suitability of its products for any particular purpose. Pan Jit products are not authorized for use in life support devices or systems. Pan Jit does not convey any license under its patent rights or rights of others.