



AKD4140-B

AK4140 Evaluation Board Rev.1

GENERAL DESCRIPTION

The AKD4140-B is the evaluation board for the AK4140, BTSC decoder. The AKD4140-B has AKM's D/A as analog output and AKM's DIT as digital (S/PDIF) output.

■ Ordering guide

AKD4140-B --- Evaluation board for AK4140
 (A cable for connecting with printer port of IBM-AT compatible PC and a control software are packed with this. The control software does not operate on Windows NT.)

FUNCTION

- Digital interface
- S/PDIF
- 1 channel output (Optical or BNC)
- Serial audio data I/F
- 1 input/output port (10-pin port)
- Serial control data I/F
- 1 input/output port (10-pin port)

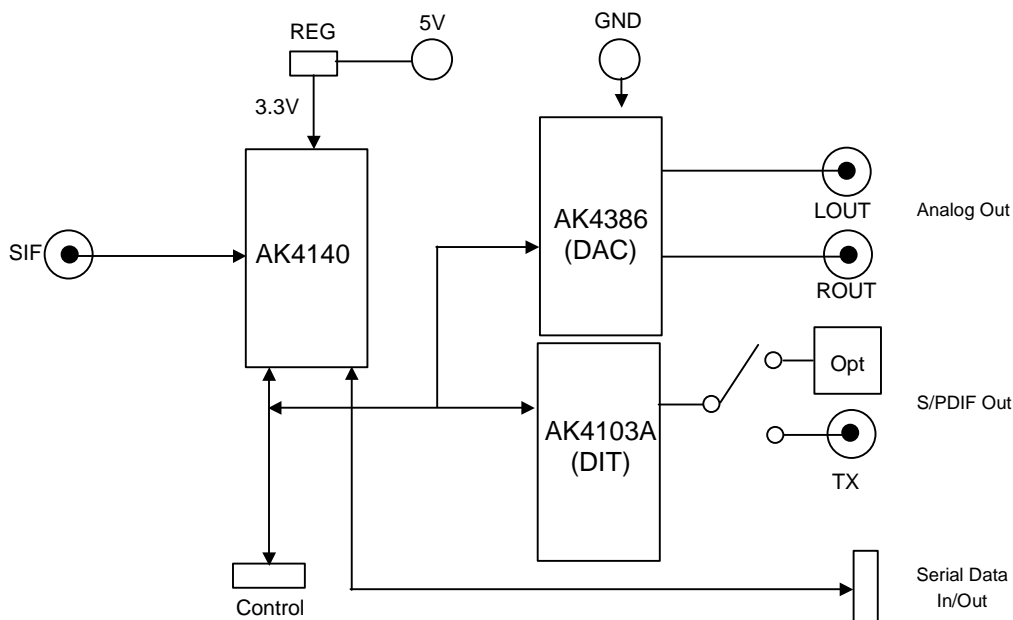

Figure 1. AKD4140-B Block Diagram

*Circuit diagram and PCB layout are attached at the end of this manual.

Evaluation Board Manual

■ Operating sequence**(1) Set up the power supply lines.**

[5V]	(Red)	= 5V
[3.3V]	(Orange)	= 3.3V (open when JP1 is shorted)
[GND]	(Black)	= 0V

(2) Set up the switches and jumpers.

Refer to the following sections.

(3) Power on.

The AK4140 should be reset once by bringing PDN (SW1) "L" upon power-up.

■ Toggle switch set-up

SW1	AK4140_PDN	Reset switch for AK4140. Set to "H" during normal operation. Bring to "L" once after the power is supplied.
SW3	DAC/DIT_PDN	Reset switch for DAC and DIT. Set to "H" during normal operation. Bring to "L" once after the power is supplied.

Table 1. Toggle switch set-up

■ LED indication

LE1	INT0	Turn on when INT0 pin goes to "H".
LE2	INT1	Turn on when INT1 pin goes to "H".

Table 2. LED indication

■ Jumper set-up.

No.	Jumper Name	Function
1	REG	Power supply setup. Short: Regulator (default) Open: +3.3V Jack
2	XTE	Set-up of X'tal. Short: GND Open: X'tal (default)
3	MCLK	Set-up of MCLK. XTL: X'tal (default) EXT: EXT
4	BICK	Set-up of BICK. Open: Master mode (default) 1/2: 128fs 1/4: 64fs
5	LRCK	Set-up of BICK. Open: Master mode (default) 1/256: 256fs 1/512: 512fs
6	TX	Set-up of TX0 output circuit. OPT : Optical (default) BNC : BNC
7	TDMIN	Set-up of TDMIN input circuit. TDMIN: TDMIN GND: GND (default)

Table 3. Jumper set-up

■ **DIP switch (SW2) set-up: -off- means “L”**

No.	Switch Name	Function	Default
1	MS	Set-up of MS pin. “L”: Slave mode. “H”: Master mode.	ON
2	CAD1	Set-up of CAD1 pin.	OFF
3	CAD0	Set-up of CAD0 pin.	OFF
4		Always “OFF”	OFF
5	TST2	Set-up of TEST pin. (always “OFF”)	OFF
6	TST1	Set-up of TEST pin. (always “OFF”)	OFF
7	TSTI2	Set-up of TEST pin. (always “OFF”)	OFF
8	TSTI1	Set-up of TEST pin. (always “OFF”)	OFF

Table 4. SW2 set-up

■ **DIP switch (SW4) set-up: -off- means “L”**

No.	Switch Name	Function	Default
1	DIT_DIF0	Set-up of AK4103A_DIF0 pin.	OFF
2	DIT_CKS0	Set-up of AK4103A_CKS0 pin.	ON
3	DIT_CKS1	Set-up of AK4103A_CKS1 pin.	OFF
4	DAC_DIF0	Set-up of AK4386_DIF0 pin.	OFF

Table 5. SW4 set-up

DIT_DIF0 (SW4_1)	AK4103A SDTI	Default
0	24bit, Left justified	Default
1	24bit, I ² S	

Table 6. Audio Interface Format of AK4103A

DIT_CKS1 (SW4_3)	DIT_CKS0 (SW4_2)	MCLK	Default
0	0	128fs	Default
0	1	256fs	
1	0	384fs	
1	1	512fs	

Table 7. Master Clock Frequency Select of AK4103A

DAC_DIF0 (SW4_1)	AK4386 SDTI	Default
0	24bit, Left justified	Default
1	16/24bit, I ² S	

Table 8. Audio Interface Format of AK4386

■ Serial control

The AK4140 can be controlled via the printer port (parallel port) of IBM-AT compatible PC. Connect PORT2 (uP-I/F) with PC by 10-line flat cable packed with the AKD4140-B. Take care of the direction of connector. There is a mark at pin#1. The pin layout of PORT2 as shown Figure 2.

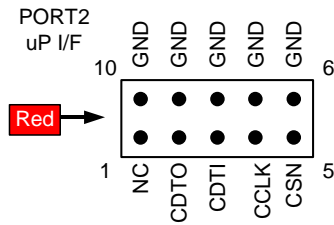

Figure 2. PORT2 pin layout

Control Software Manual

■ Set-up of evaluation board and control software

1. Set up the AKD4140-B according to the **Operating Sequence** located on page 2.
2. Connect IBM-AT compatible PC with AKD4140-B by 10-line type flat cable (packed with AKD4140-B). Take care of the direction of 10pin header. (Please install the driver in the CD-ROM when this control software is used on Windows 2000/XP. Please refer "Installation Manual of Control Software Driver by AKM device control software". In case of Windows95/98/ME, this installation is not needed. This control software does not operate on Windows NT.)
3. Insert the CD-ROM labeled "AKD4140-B Evaluation Kit" into the CD-ROM drive.
4. Access the CD-ROM drive and double-click the icon of "akd4140.exe" to set up the control program.
5. Please evaluate according to the following.

■ Operation flow

Keep the following flow.

1. Set up the control program according to explanation above.
2. Click "Port Reset" button.

■ Explanation of each buttons

1. [Port Reset] : Set up the USB interface board (AKDUSBIF-A) .
2. [Write default] : Initialize the register of AK4140.
3. [All Write] : Write all registers that is currently displayed.
4. [Function1] : Dialog to write data by keyboard operation.
5. [Function2] : Dialog to write data by keyboard operation.
6. [Function3] : The sequence of register setting can be set and executed.
7. [Function4] : The sequence that is created on [Function3] can be assigned to buttons and executed.
8. [Function5]: The register setting that is created by [SAVE] function on main window can be assigned to buttons and executed.
9. [SAVE] : Save the current register setting.
10. [OPEN] : Write the saved values to all register.
11. [Write] : Dialog to write data by mouse operation.

■ Indication of data

Input data is indicated on the register map. Red letter indicates "H" or "1" and blue one indicates "L" or "0". Blank is the part that is not defined in the datasheet.

■ Explanation of each dialog

1. [Write Dialog]: Dialog to write data by mouse operation

There are dialogs corresponding to each register.

Click the [Write] button corresponding to each register to set up the dialog. If you check the check box, data becomes "H" or "1". If not, "L" or "0".

If you want to write the input data to AK4140, click [OK] button. If not, click [Cancel] button.

2. [Function1 Dialog] : Dialog to write data by keyboard operation

Address Box: Input registers address in 2 figures of hexadecimal.

Data Box: Input registers data in 2 figures of hexadecimal.

If you want to write the input data to AK4140, click [OK] button. If not, click [Cancel] button.

3. [Function2 Dialog] : Dialog to evaluate ATT

Address Box: Input registers address in 2 figures of hexadecimal.

Start Data Box: Input starts data in 2 figures of hexadecimal.

End Data Box: Input end data in 2 figures of hexadecimal.

Interval Box: Data is written to AK4140 by this interval.

Step Box: Data changes by this step.

Mode Select Box:

*If you check this check box, data reaches end data, and returns to start data.

[Example] Start Data = 00, End Data = 09

Data flow: 00 01 02 03 04 05 06 07 08 09 09 08 07 06 05 04 03 02 01 00

*If you do not check this check box, data reaches end data, but does not return to start data.

[Example] Start Data = 00, End Data = 09

Data flow: 00 01 02 03 04 05 06 07 08 09

If you want to write the input data to AK4140, click [OK] button. If not, click [Cancel] button.

4. [Save] and [Open]

4-1. [Save]

Save the current register setting data. The extension of file name is “akr”.

(Operation flow)

- (1) Click [Save] Button.
- (2) Set the file name and push [Save] Button. The extension of file name is “akr”.

4-2. [Open]

The register setting data saved by [Save] is written to AK4396. The file type is the same as [Save].

(Operation flow)

- (1) Click [Open] Button.
- (2) Select the file (*.akr) and Click [Open] Button.

5. [Function3 Dialog]

The sequence of register setting can be set and executed.

(1) Click [F3] Button.

(2) Set the control sequence.

Set the address, Data and Interval time. Set “-1” to the address of the step where the sequence should be paused.

(3) Click [Start] button. Then this sequence is executed.

The sequence is paused at the step of Interval="-1". Click [START] button, the sequence restarts from the paused step.

This sequence can be saved and opened by [Save] and [Open] button on the Function3 window. The extension of file name is “aks”.

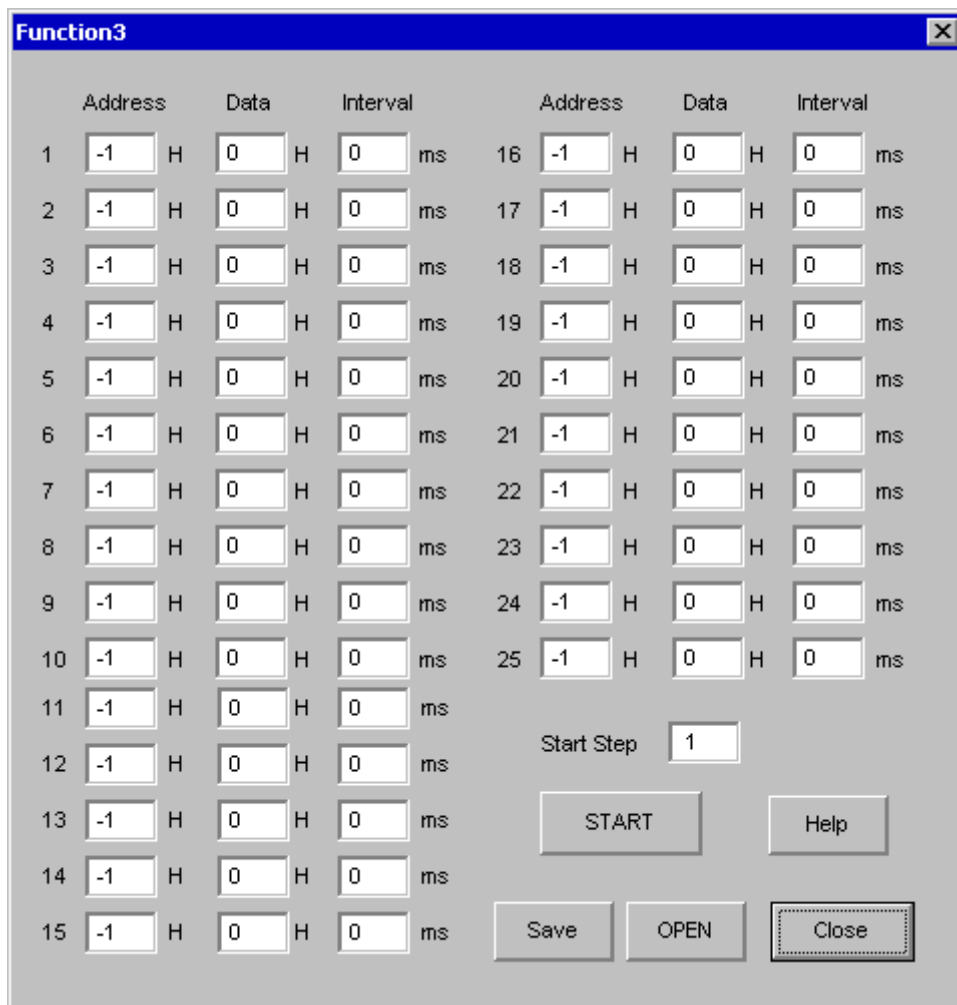

Figure 3. Window of [F3]

6. [Function4 Dialog]

The sequence that is created on [Function3] can be assigned to buttons and executed. When [F4] button is clicked, the window as shown in Figure 4 opens.

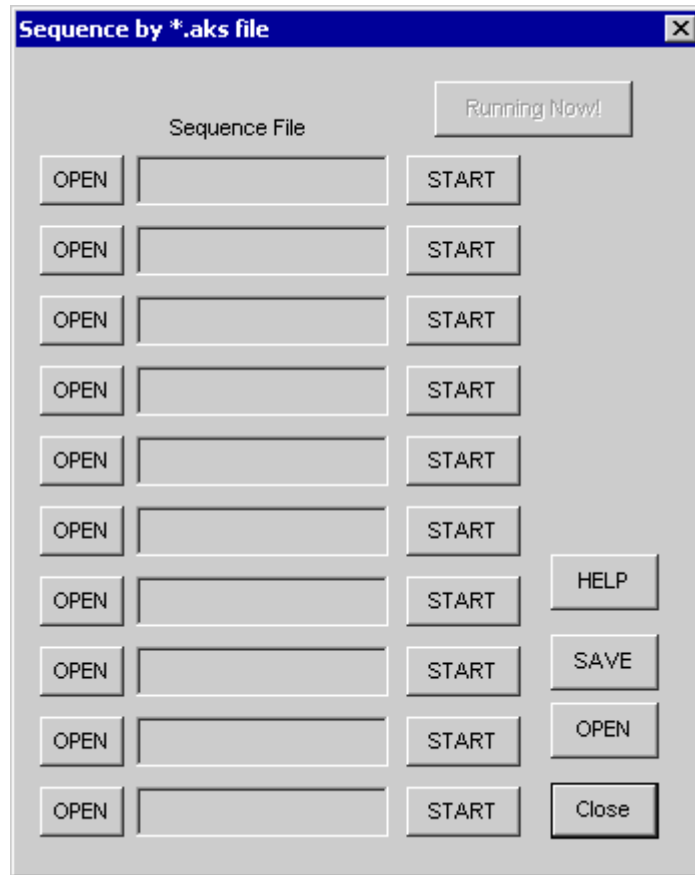

Figure 4. [F4] window

6-1. [OPEN] buttons on left side and [START] buttons

(1) Click [OPEN] button and select the sequence file (*.aks).

The sequence file name is displayed as shown in Figure 5.

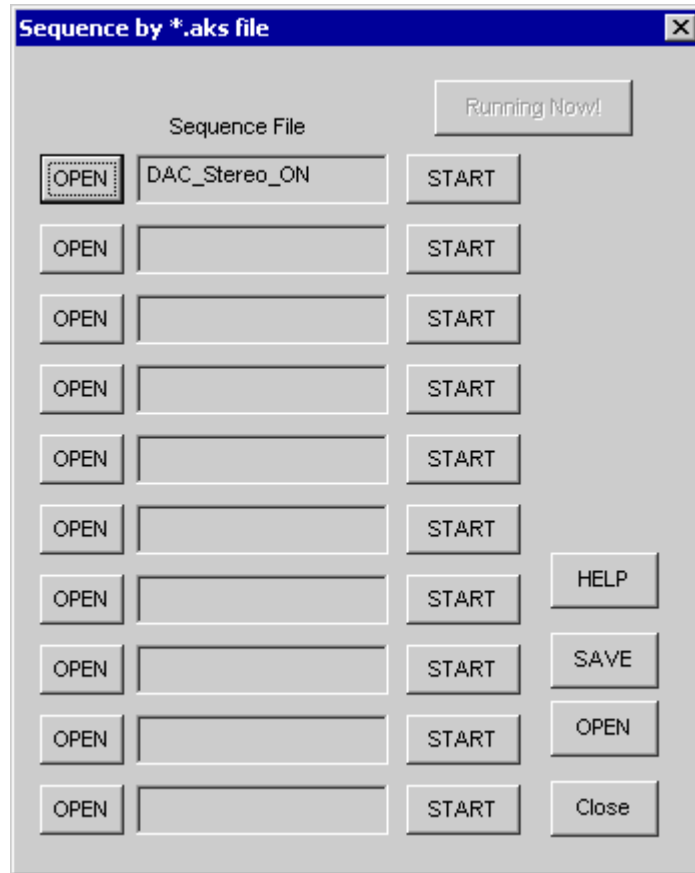

Figure 5. [F4] window(2)

(2) Click [START] button, then the sequence is executed.

3-2. [SAVE] and [OPEN] buttons on right side

[SAVE] : The sequence file names can assign be saved. The file name is *.ak4.

[OPEN] : The sequence file names assign that are saved in *.ak4 are loaded.

3-3. Note

- (1) This function doesn't support the pause function of sequence function.
- (2) All files need to be in same folder used by [SAVE] and [OPEN] function on right side.
- (3) When the sequence is changed in [Function3], the file should be loaded again in order to reflect the change.

7. [Function5 Dialog]

The register setting that is created by [SAVE] function on main window can be assigned to buttons and executed. When [F5] button is clicked, the following window as shown in Figure 6 opens.

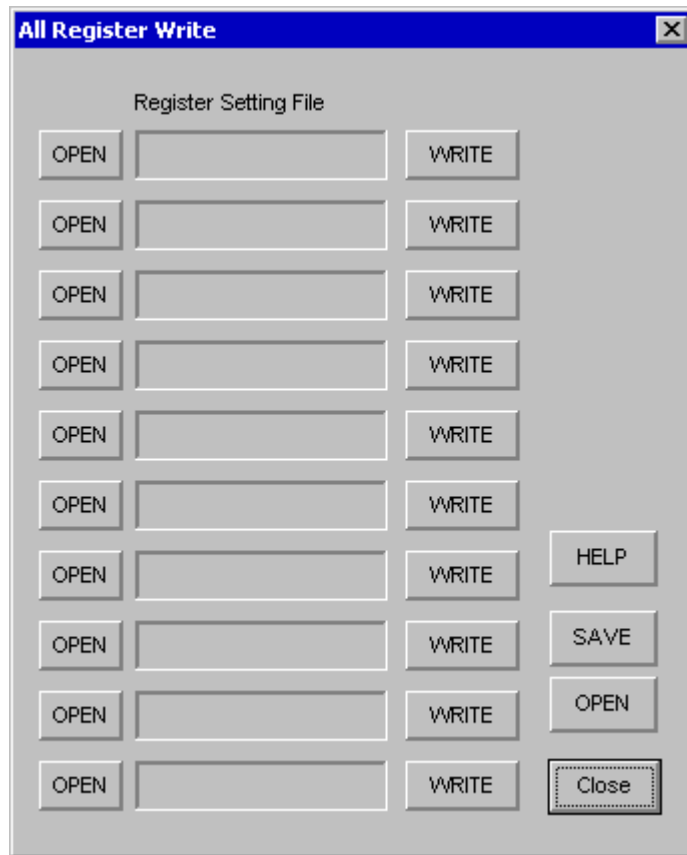

Figure 6. [F5] window

7-1. [OPEN] buttons on left side and [WRITE] button

- (1) Click [OPEN] button and select the register setting file (*.akr).
- (2) Click [WRITE] button, then the register setting is executed.

7-2. [SAVE] and [OPEN] buttons on right side

[SAVE] : The register setting file names assign can be saved. The file name is *.ak5.

[OPEN] : The register setting file names assign that are saved in *.ak5 are loaded.

7-3. Note

- (1) All files need to be in same folder used by [SAVE] and [OPEN] function on right side.
- (3) When the register setting is changed by [Save] Button in main window, the file should be loaded again in order to reflect the change.

MEASUREMENT RESULTS

[Measurement condition]

- Measurement unit : Audio Precision, System Two Cascade
- MCLK : 256fs
- SCLK : 64fs
- fs : 48kHz
- Bit : 16bit
- Power Supply : AVDD = DVDD = 3.3V
- Bandwidth : 22Hz-15kHz
- Interface : DIT
- Temperature : Room
- ATTL bit = ATTR bit = "0" (attenuation = off)

Parameter		Result (Lch / Rch)	Unit
S/(N+D) (-1dB Input, 1kHz)	MONO	-57.1	dB
	Stereo	-57.0 / -57.0	dB
	SAP	-41.4	dB
D-Range (-60dB Input, A-weighting)	MONO	76.4	dB
	Stereo	74.9 / -74.9	dB
	SAP	86.8	dB
S/N (Input off, A-weighting)	MONO	76.1	dB
	Stereo	74.8 / 74.7	dB
	SAP	88.7	dB

Performance Plots

STEREO:

- Figure 1. THD+N vs. Input Level (1kHz)
- Figure 2. THD+N vs. Input Frequency (-15dB)
- Figure 3. Linearity (1kHz)
- Figure 4. Frequency Response (-15dB)
- Figure 5. Crosstalk (Left Channel = Off, Right Channel = -15dB)
- Figure 6. FFT Plot (-1dB)
- Figure 7. FFT Plot (-60dB)
- Figure 8. FFT Plot (no input)

MONO:

- Figure 9. THD+N vs. Input Level (1kHz)
- Figure 10. THD+N vs. Input Frequency (-15dB)
- Figure 11. Linearity (1kHz)
- Figure 12. Frequency Response (-15dB)
- Figure 13. FFT Plot (-1dB)
- Figure 14. FFT Plot (-60dB)
- Figure 15. FFT Plot (no input)

SAP:

- Figure 16. THD+N vs. Input Level (1kHz)
- Figure 17. THD+N vs. Input Frequency (-15dB)
- Figure 18. Linearity (1kHz)
- Figure 19. Frequency Response (-15dB)
- Figure 20. FFT Plot (-1dB)
- Figure 21. FFT Plot (-60dB)
- Figure 22. FFT Plot (no input)

[Plot: STEREO]
AKM

04/19/06 17:29:47

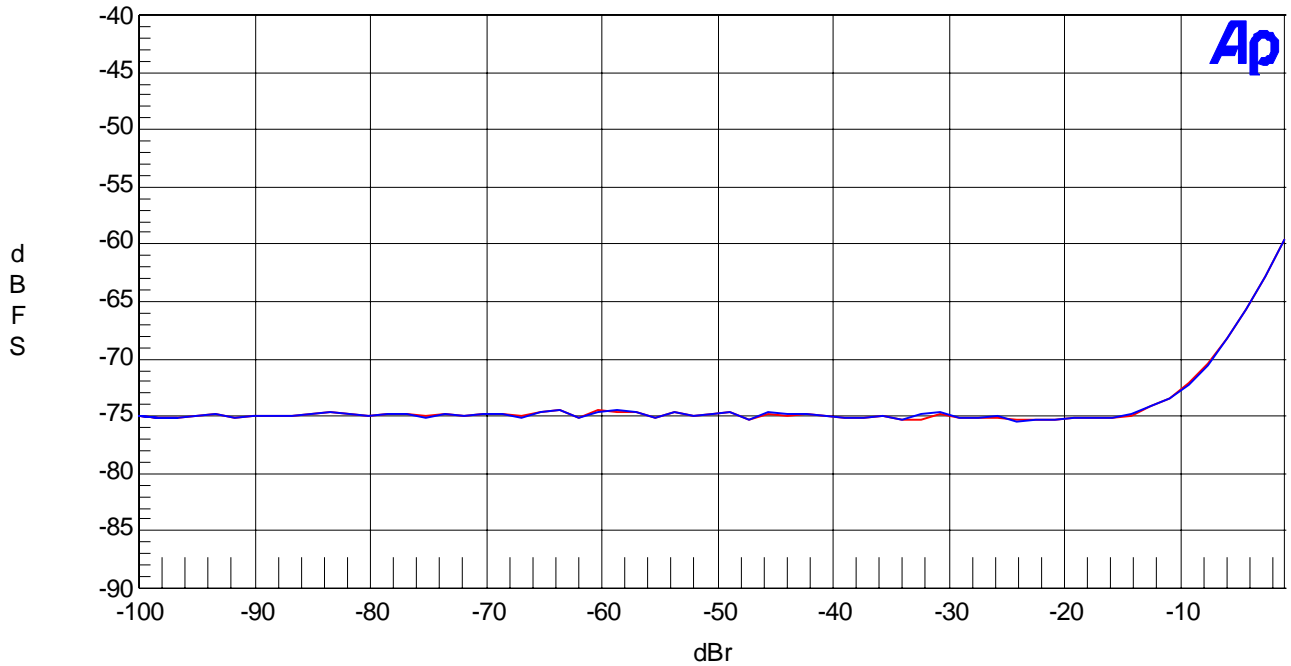

Figure 1. THD+N vs. Input Level (1kHz)

AKM

04/19/06 17:37:04

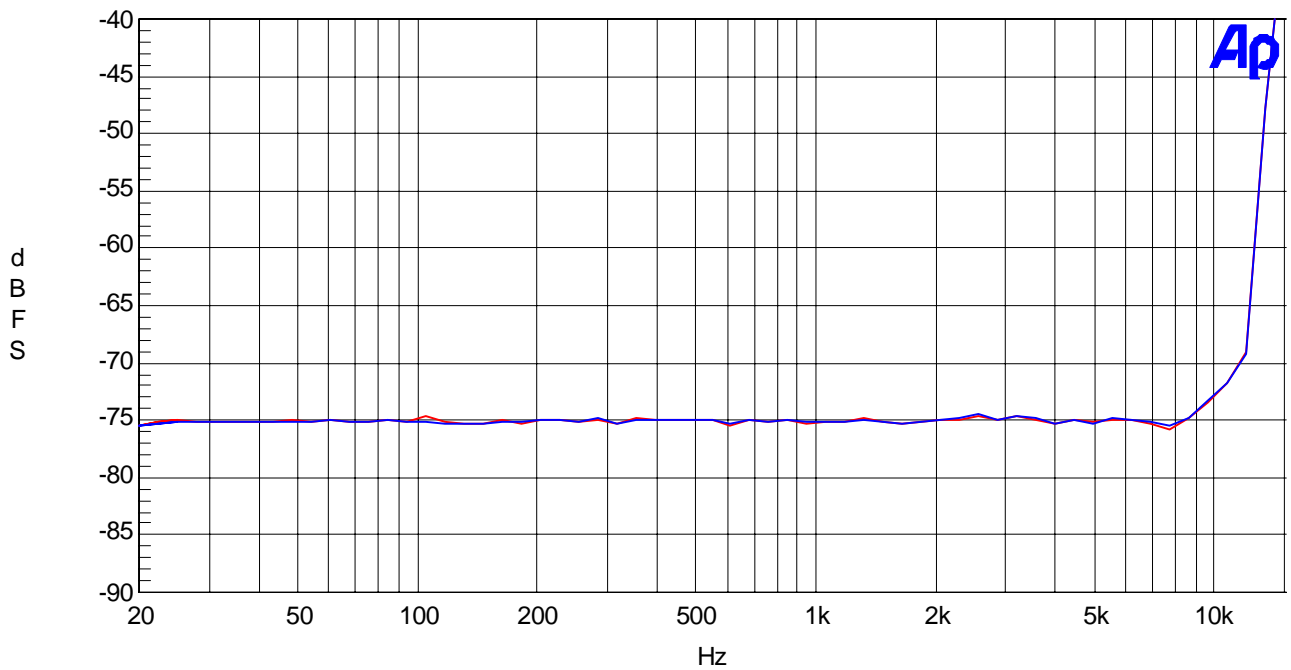

Figure 2. THD+N vs. Input Frequency (-15dB)

AKM

04/19/06 17:41:25

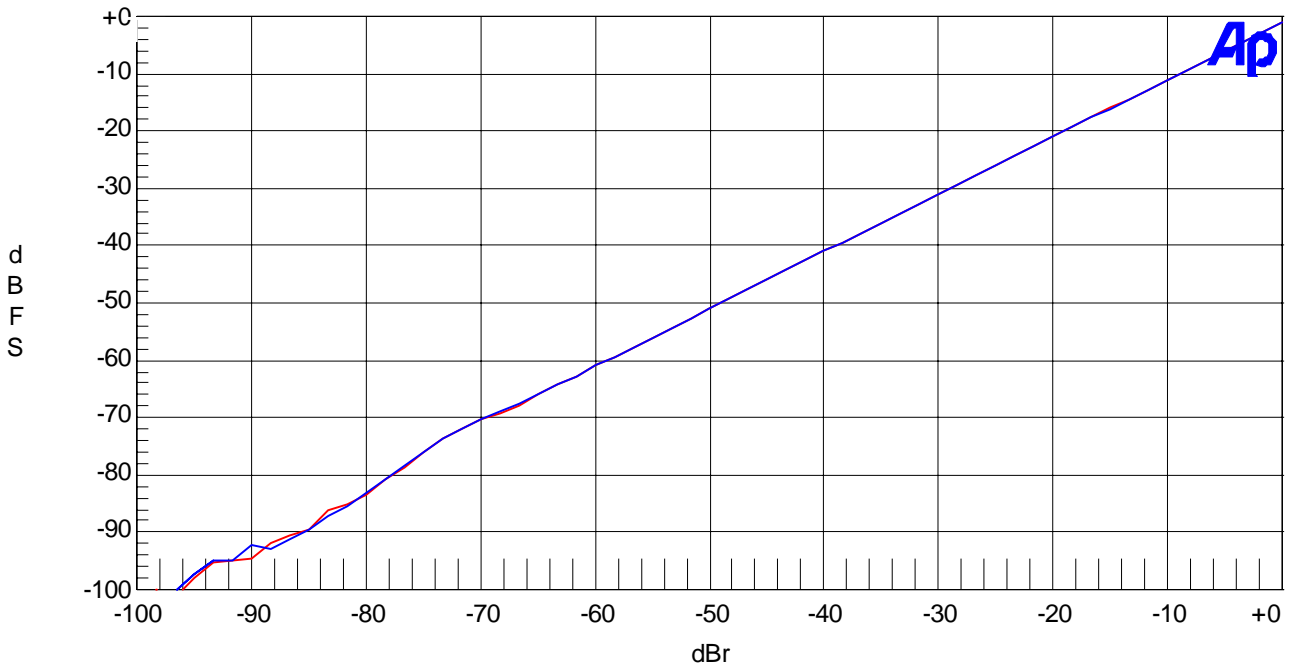

Figure 3. Linearity (1kHz)

AKM

04/19/06 17:44:51

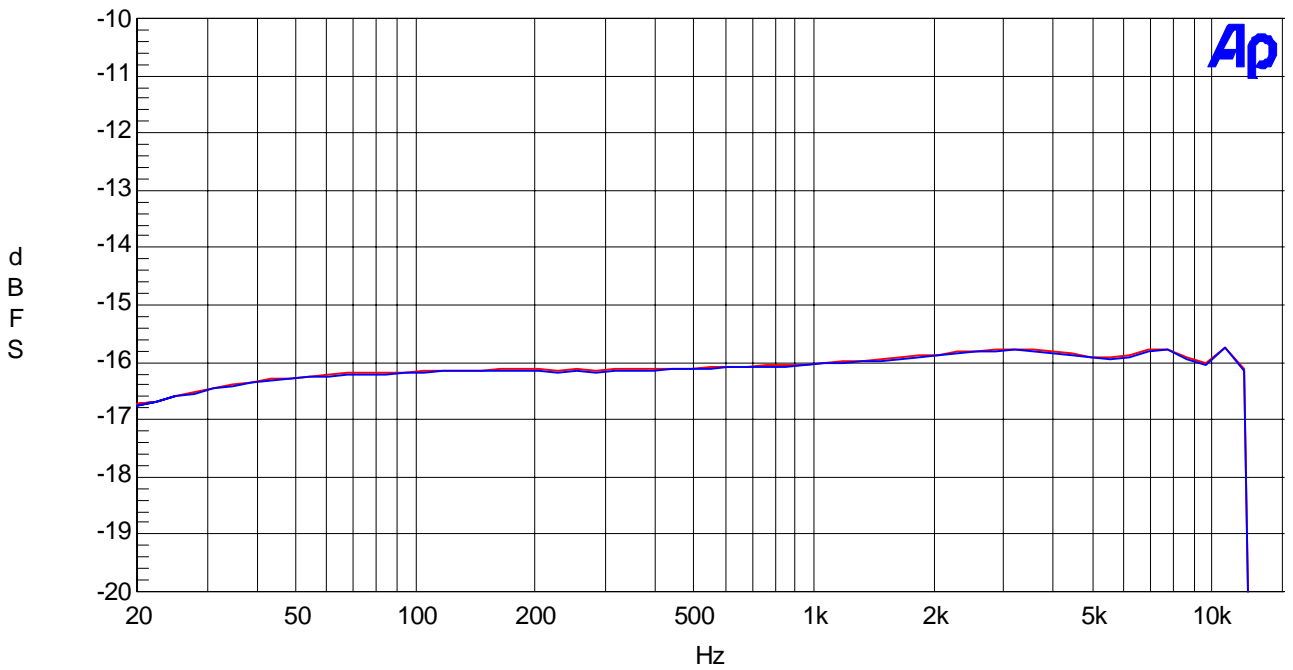

Figure 4. Frequency Response (-15dB)

AKM

04/19/06 17:46:33

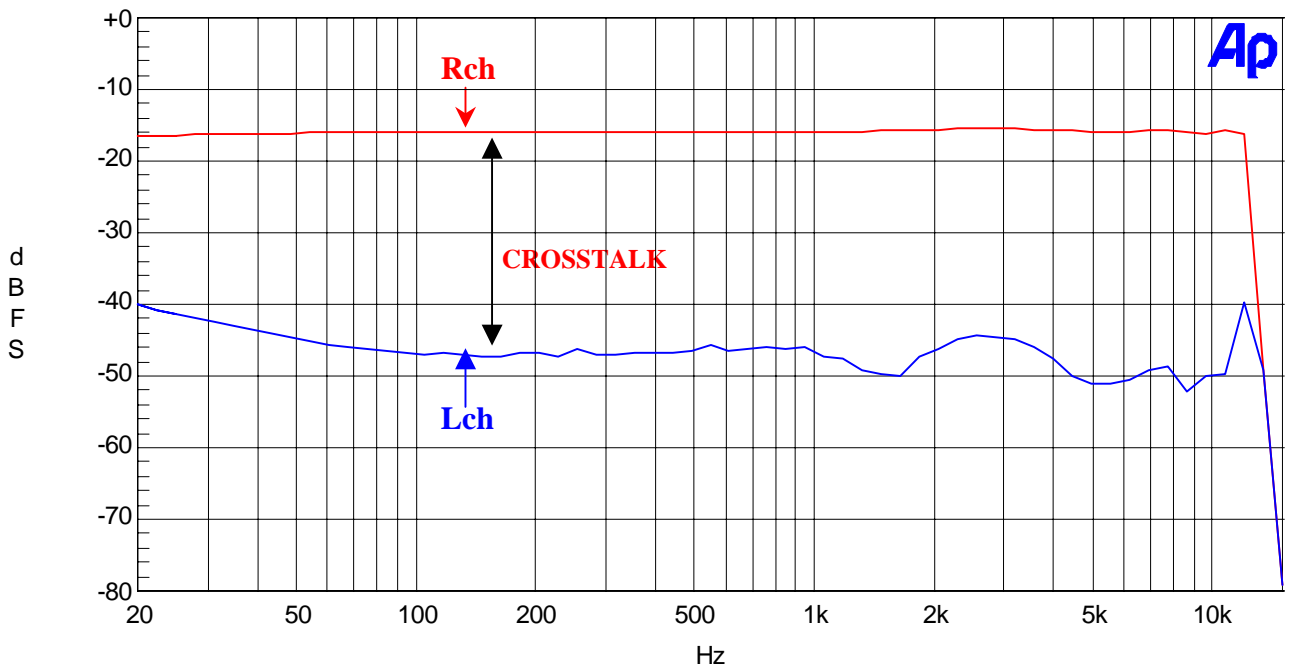

Figure 5. Crosstalk (Left Channel = Off, Right Channel = -15dB)

AKM

04/19/06 17:48:52

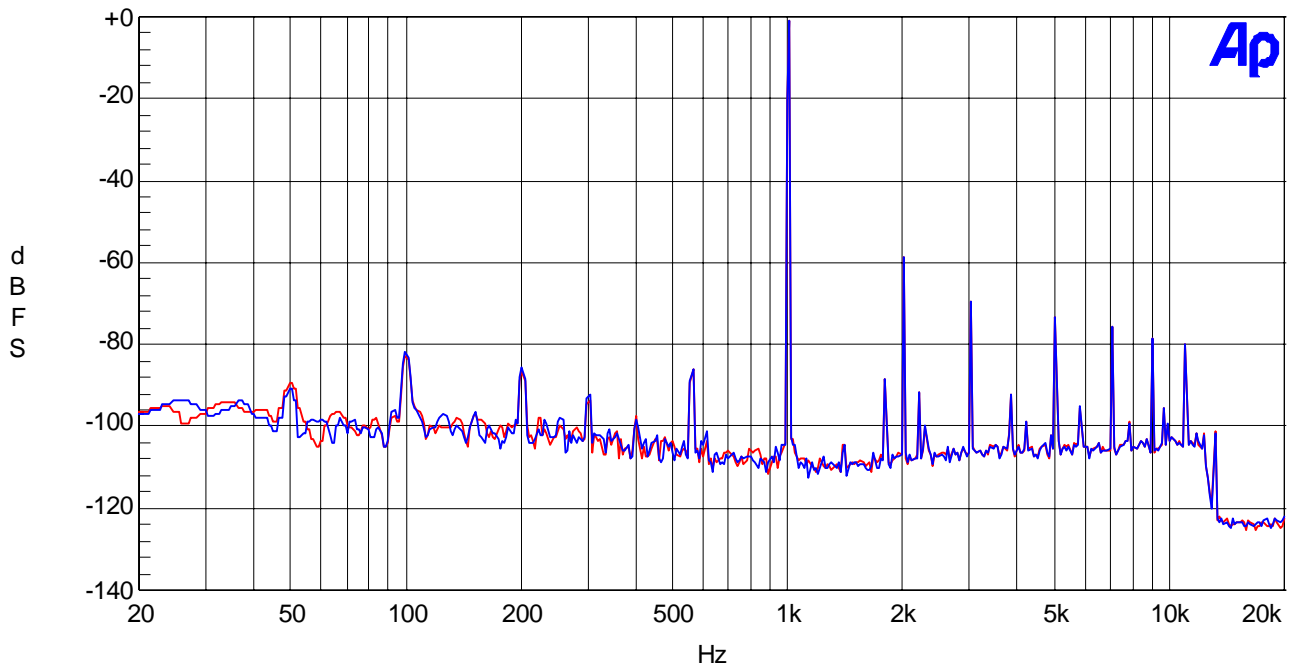

Figure 6. FFT Plot (-1dB)

AKM

04/19/06 17:49:52

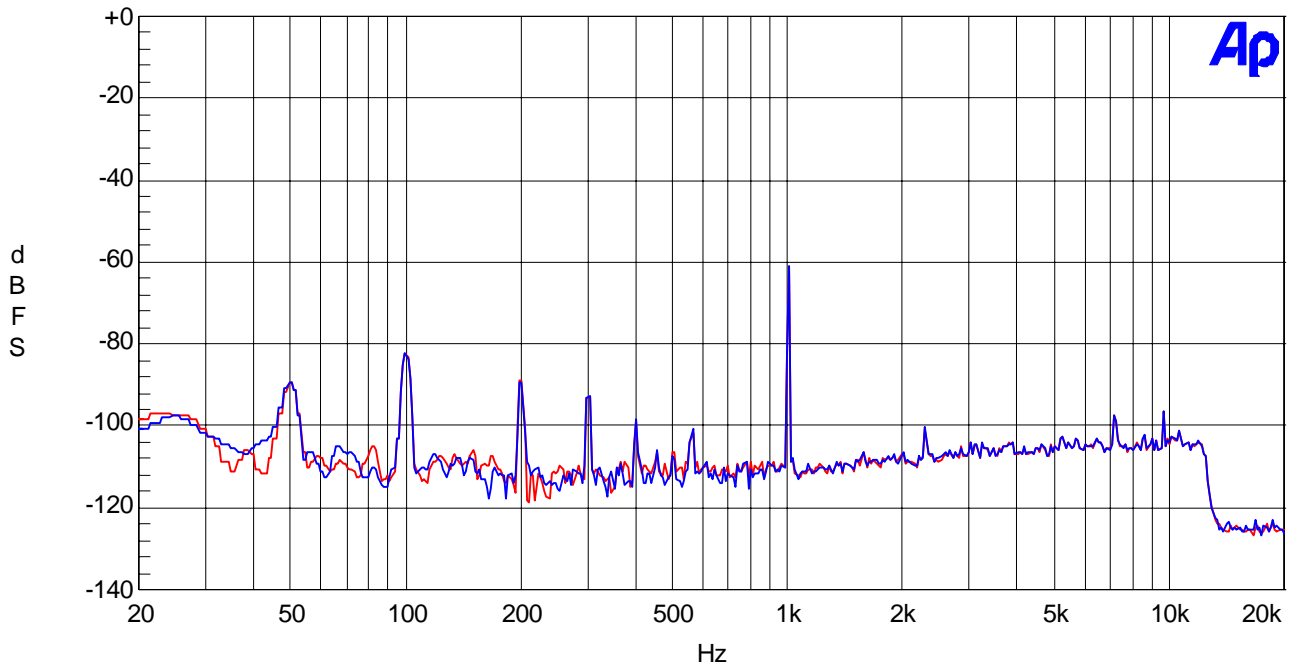

Figure 7. FFT Plot (-60dB)

AKM

04/19/06 17:50:30

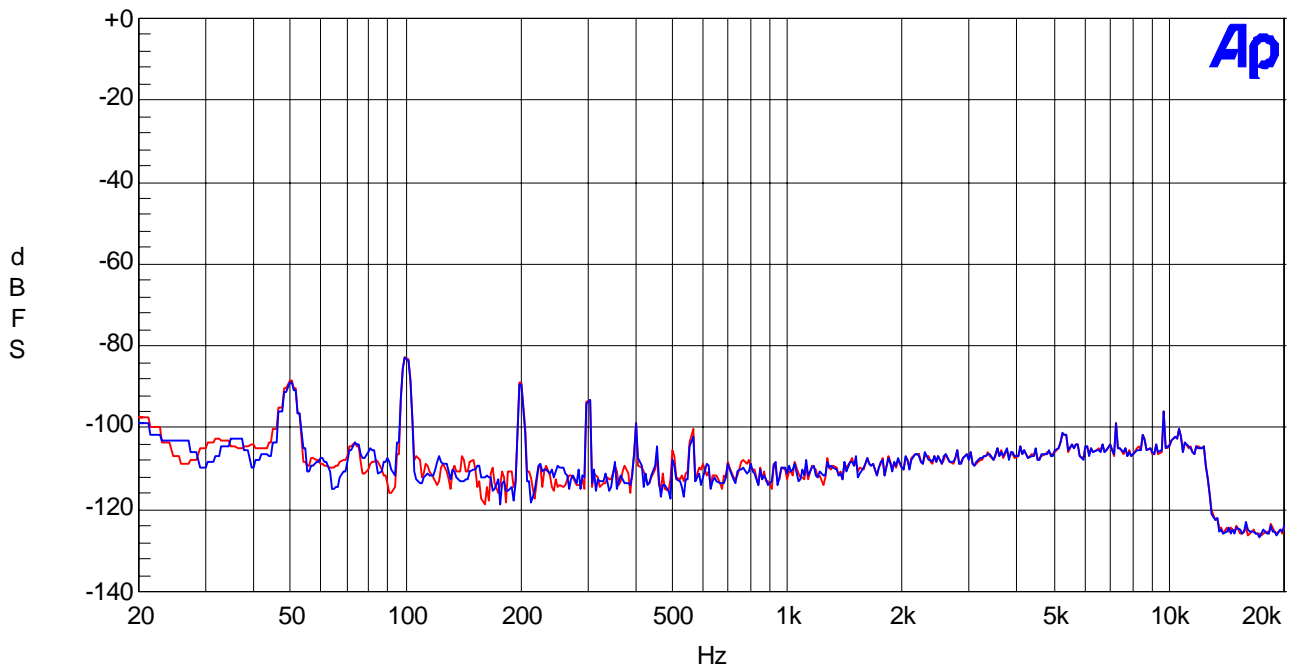

Figure 8. FFT Plot (no input)

[Plot: MONO]
AKM

04/19/06 17:53:32

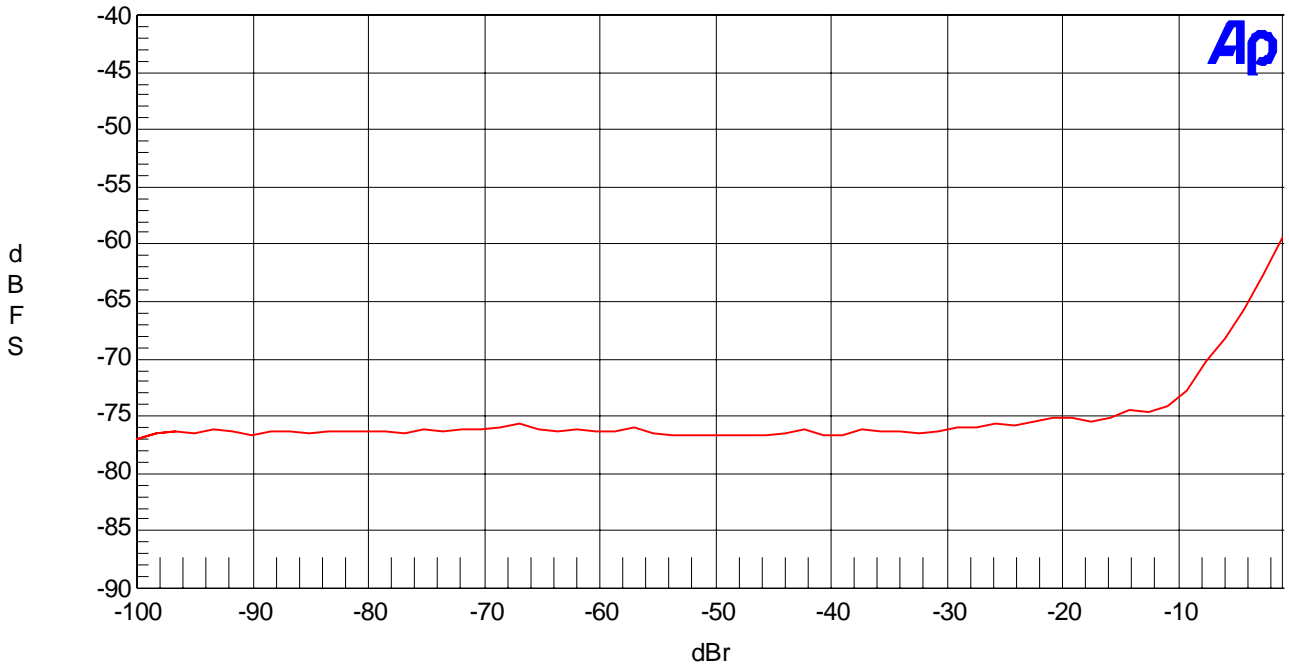

Figure 9. THD+N vs. Input Level (1kHz)

AKM

04/19/06 17:54:23

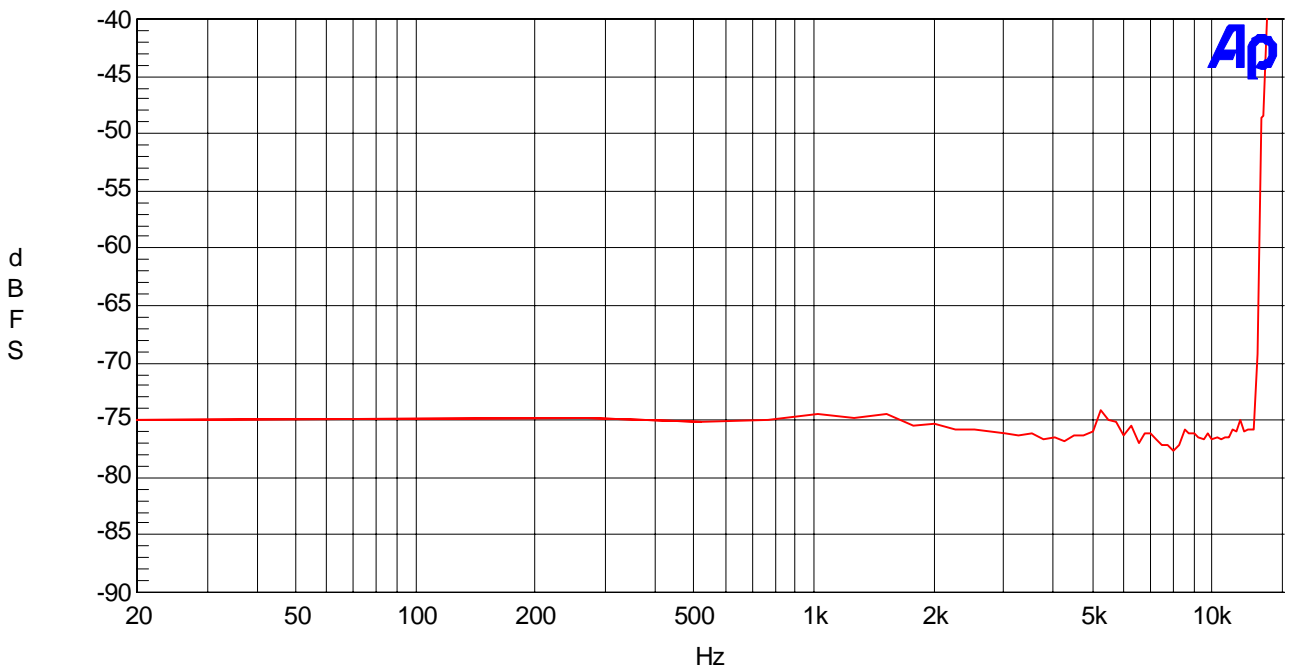

Figure 10. THD+N vs. Input Frequency (-15dB)

AKM

04/19/06 17:59:38

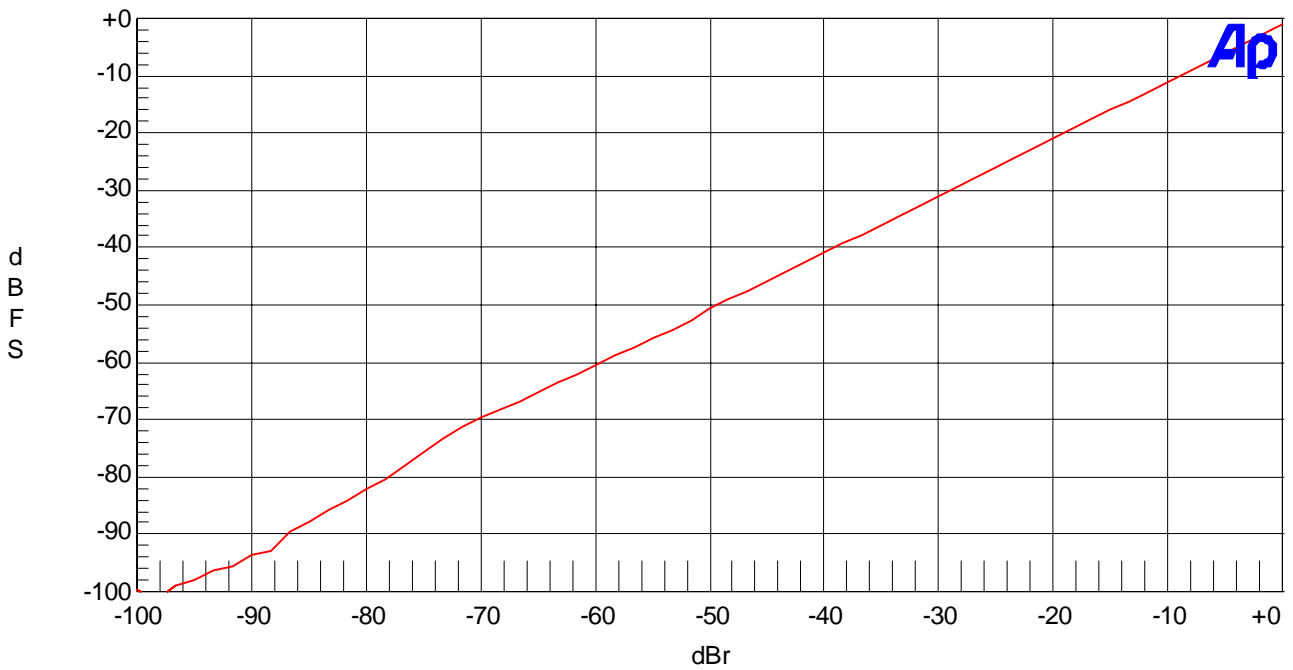

Figure 11. Linearity (1kHz)

AKM

04/19/06 18:22:16

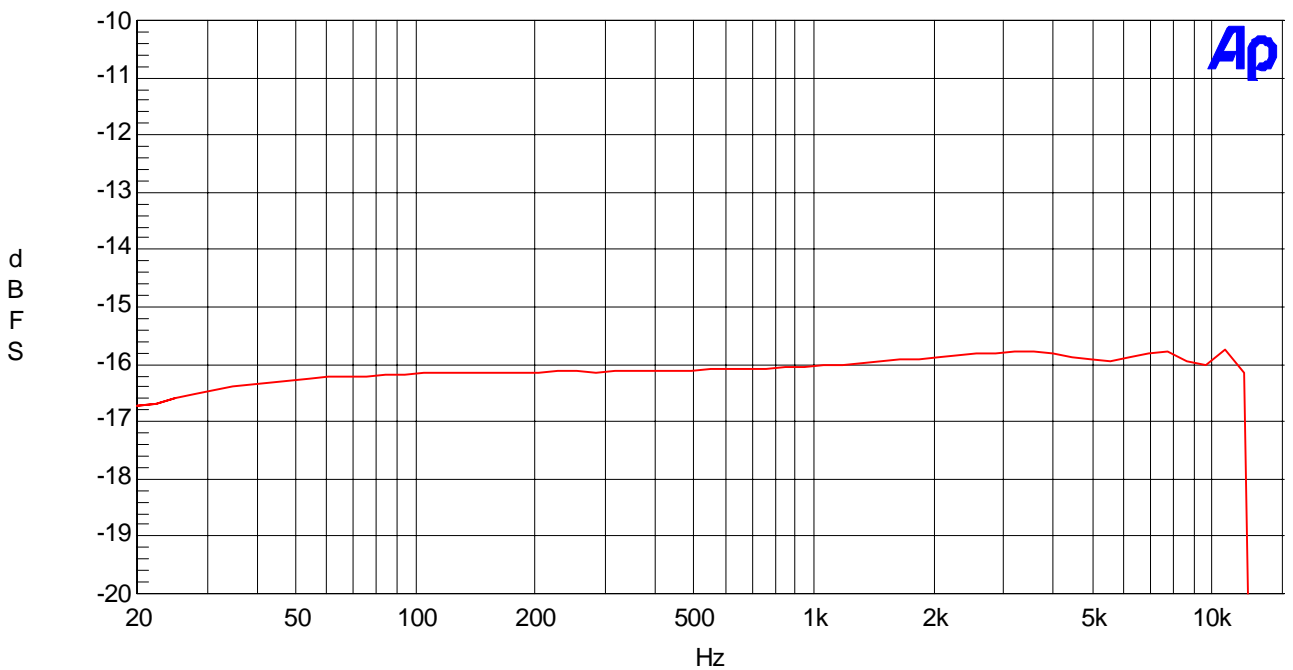

Figure 12. Frequency Response (-15dB)

AKM

04/19/06 18:04:41

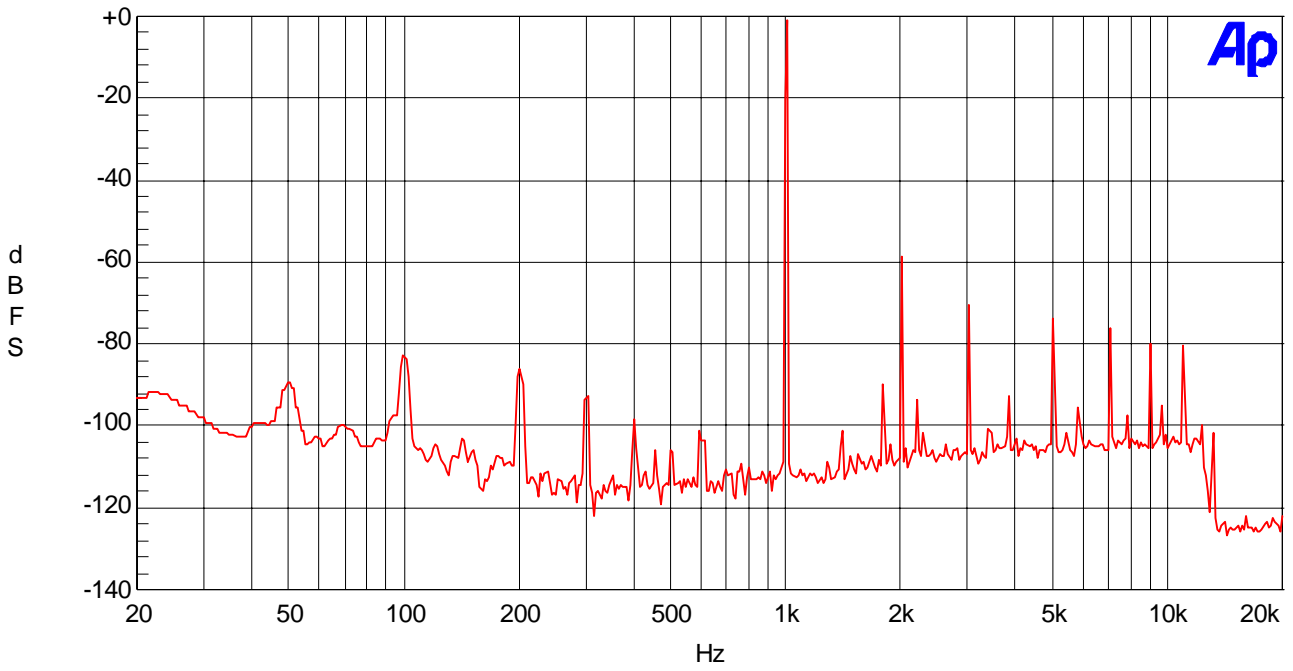

Figure 13. FFT Plot (-1dB)

AKM

04/19/06 18:04:06

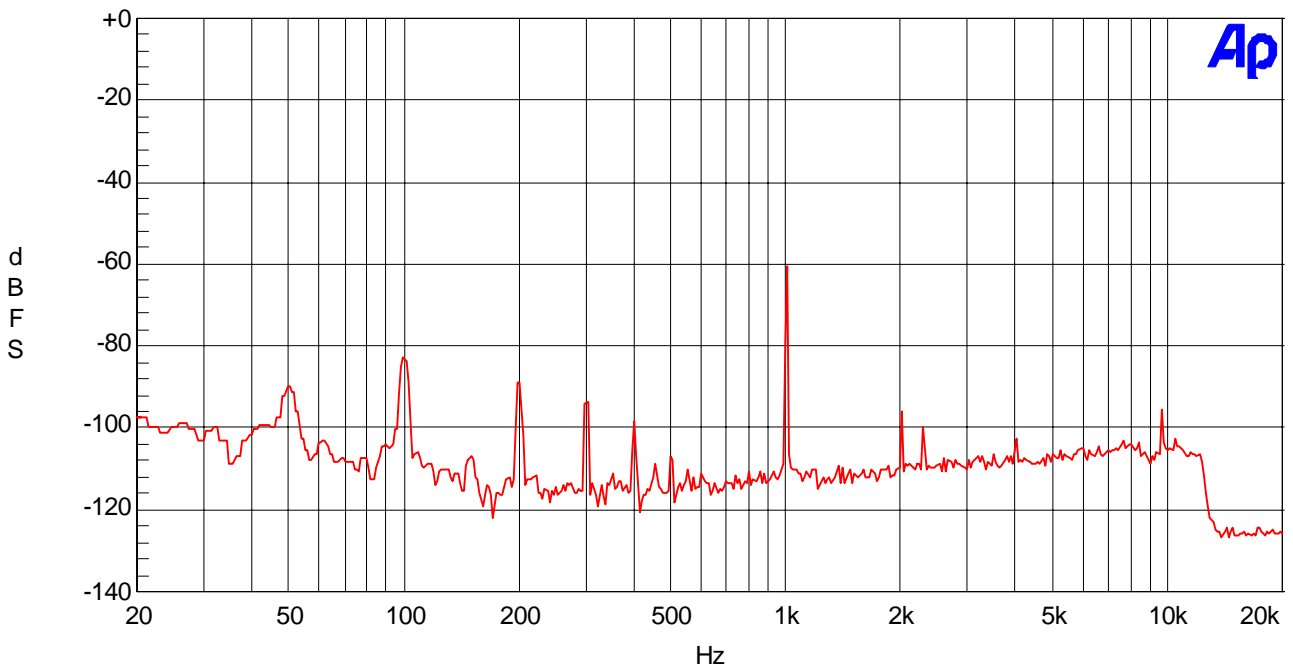

Figure 14. FFT Plot (-60dB)

AKM

04/19/06 18:05:06

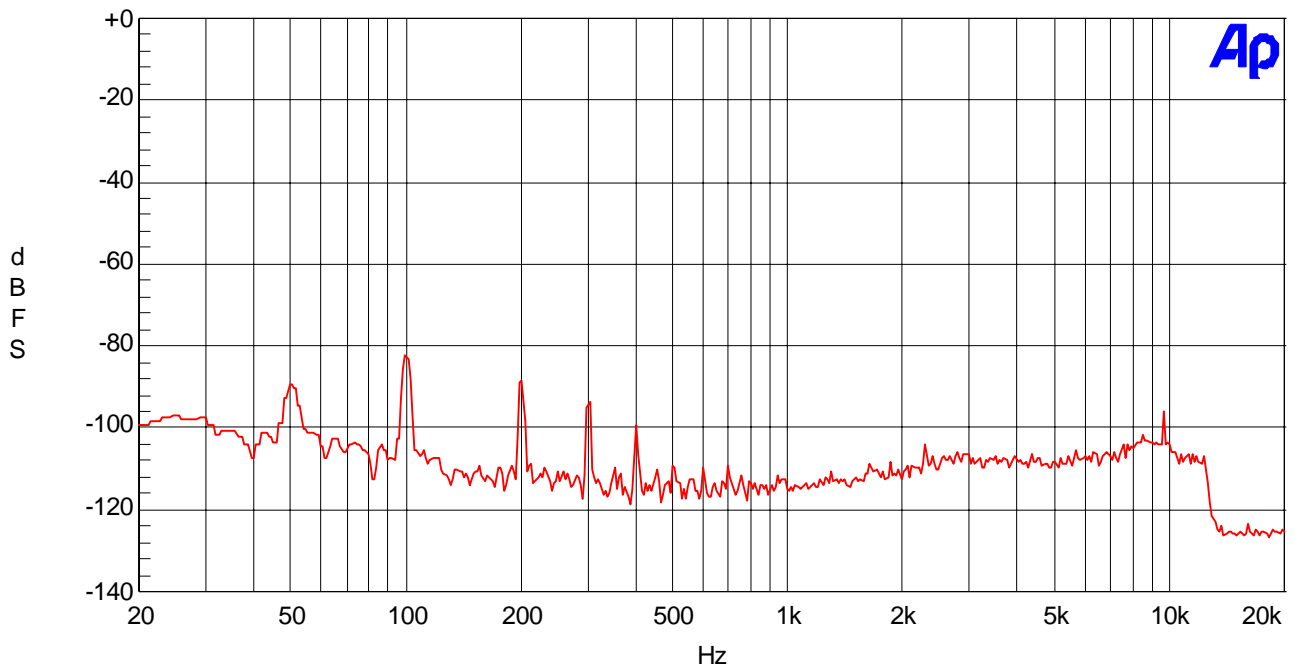

Figure 15. FFT Plot (no input)

[Plot: SAP]

AKM

04/19/06 18:08:57

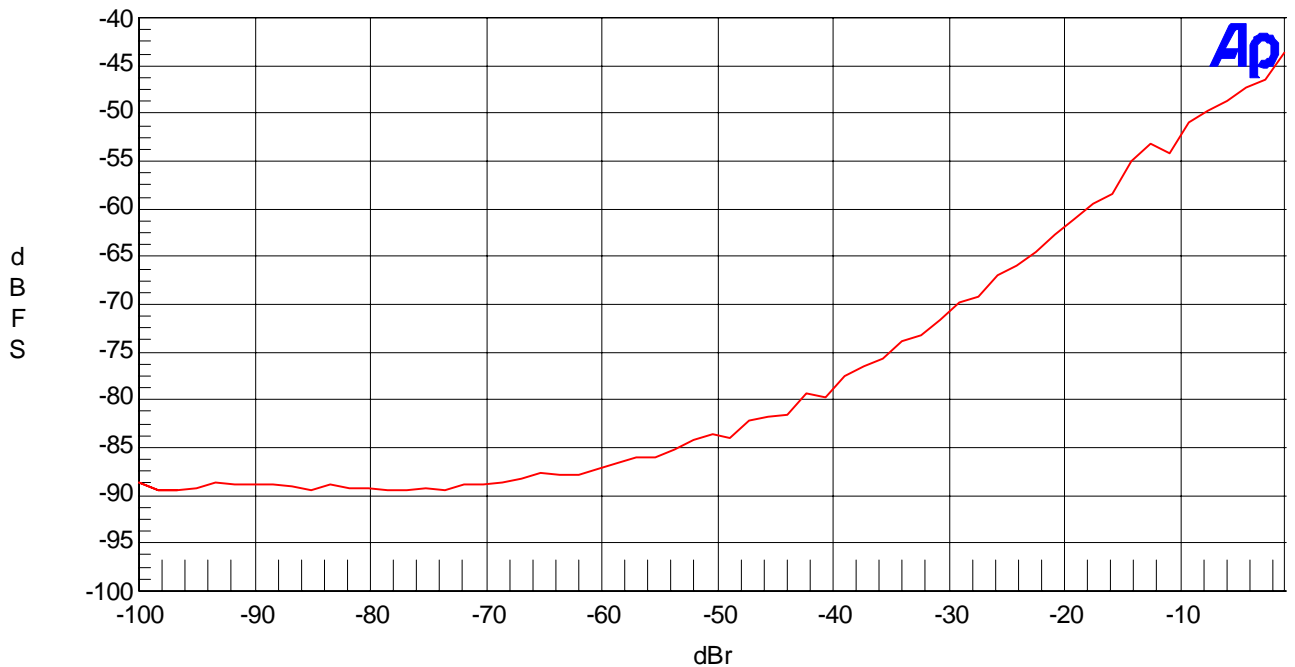

Figure 16. THD+N vs. Input Level (1kHz)

AKM

04/19/06 18:10:36

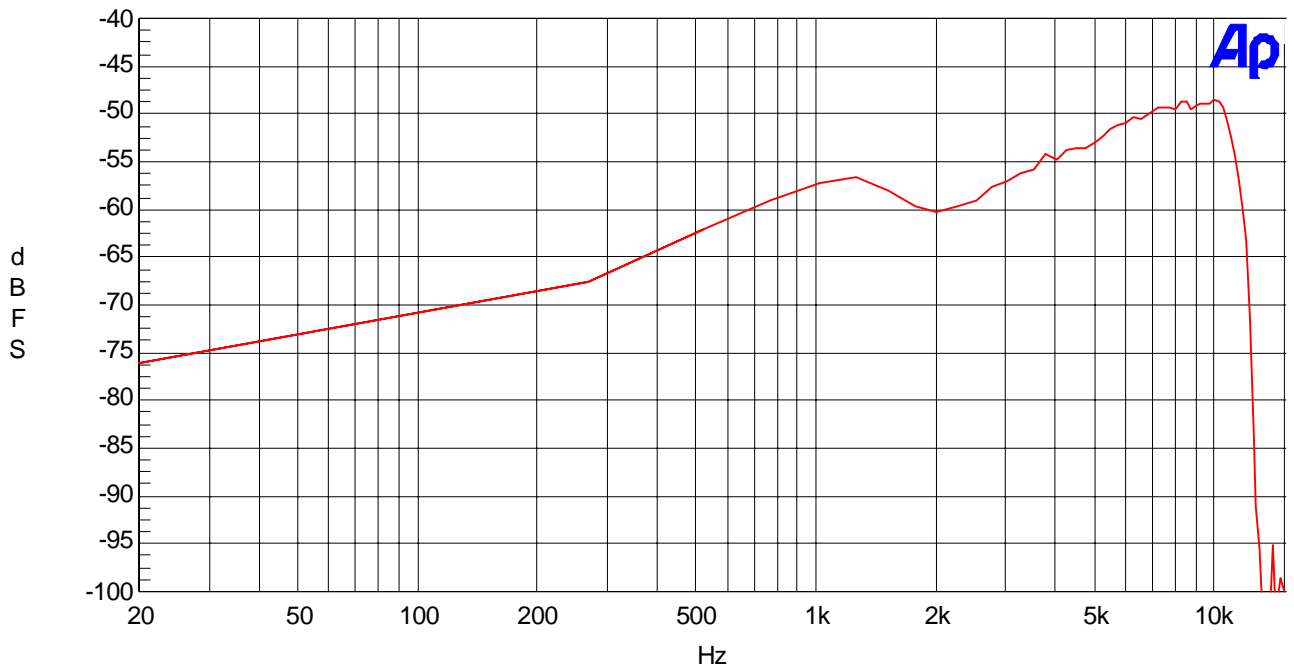

Figure 17. THD+N vs. Input Frequency (-15dB)

AKM

04/19/06 18:13:17

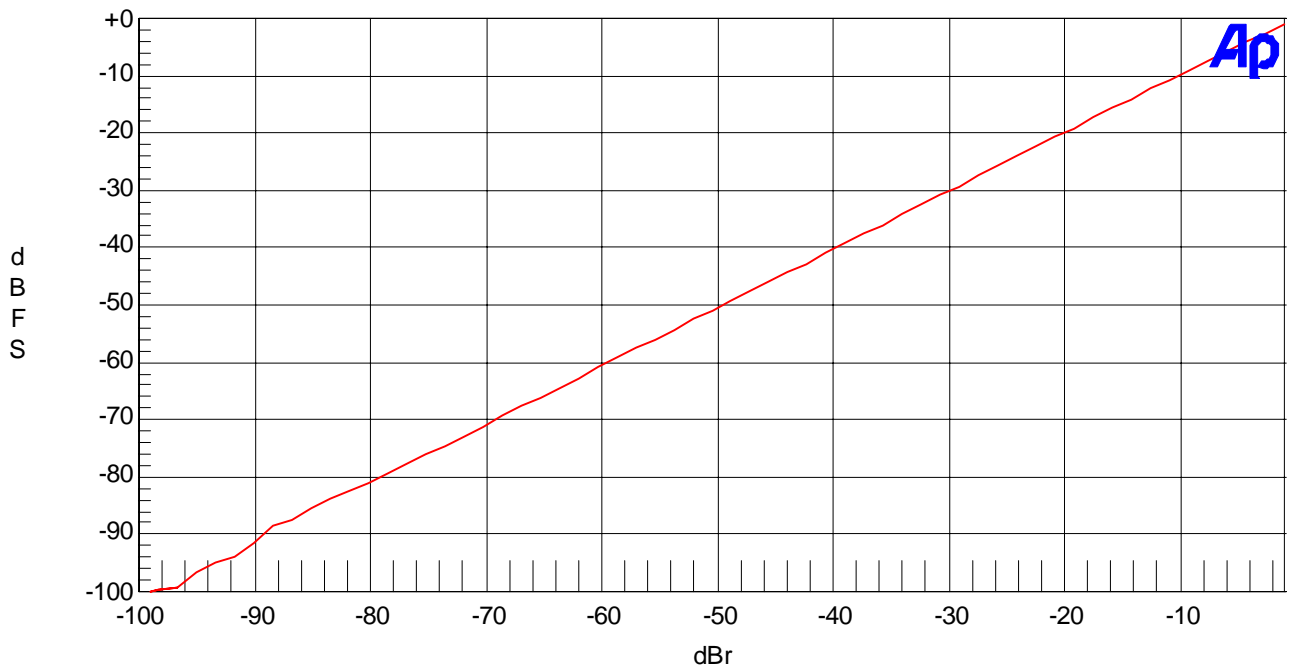

Figure 18. Linearity (1kHz)

AKM

04/19/06 18:15:23

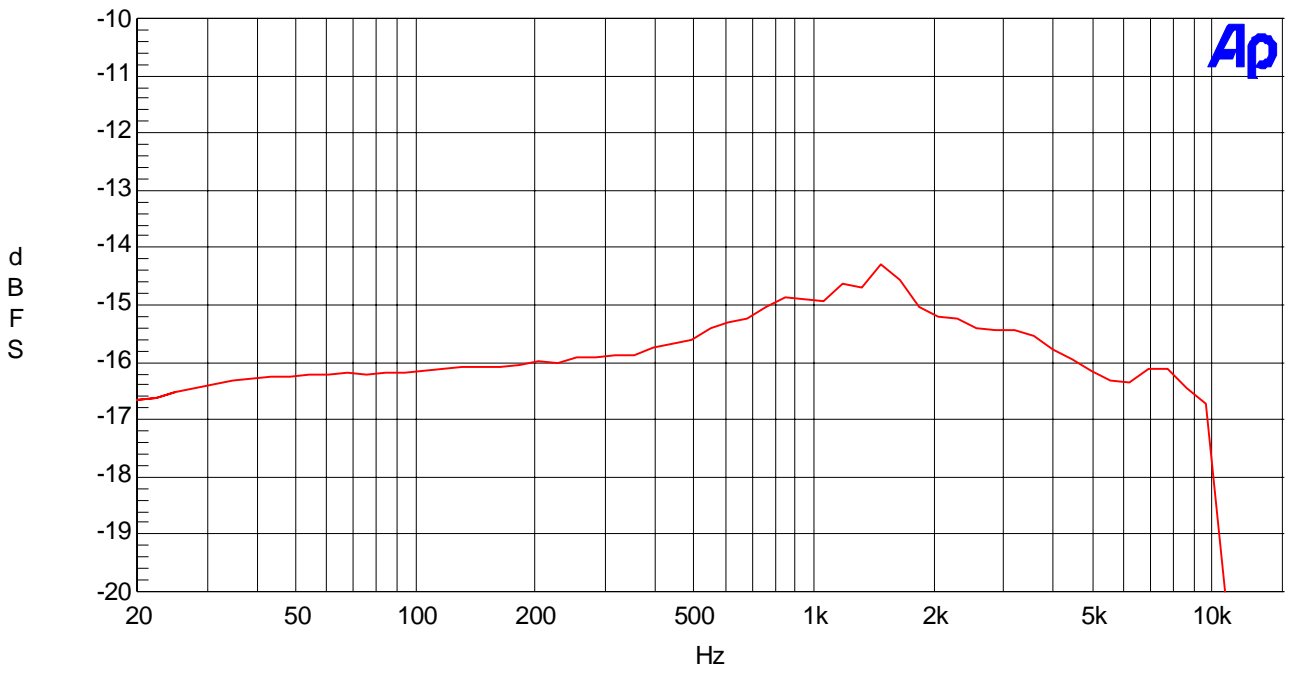

Figure 19. Frequency Response (-15dB)

AKM

04/19/06 18:17:12

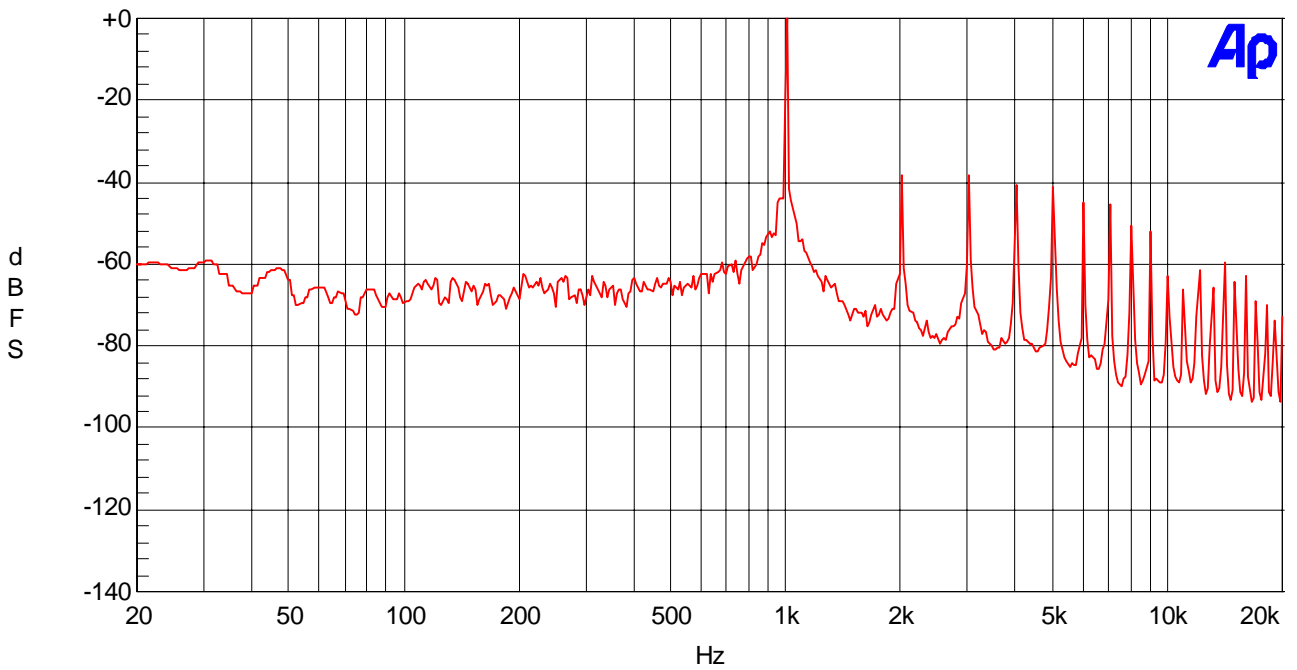

Figure 20. FFT Plot (-1dB)

AKM

04/19/06 18:17:59

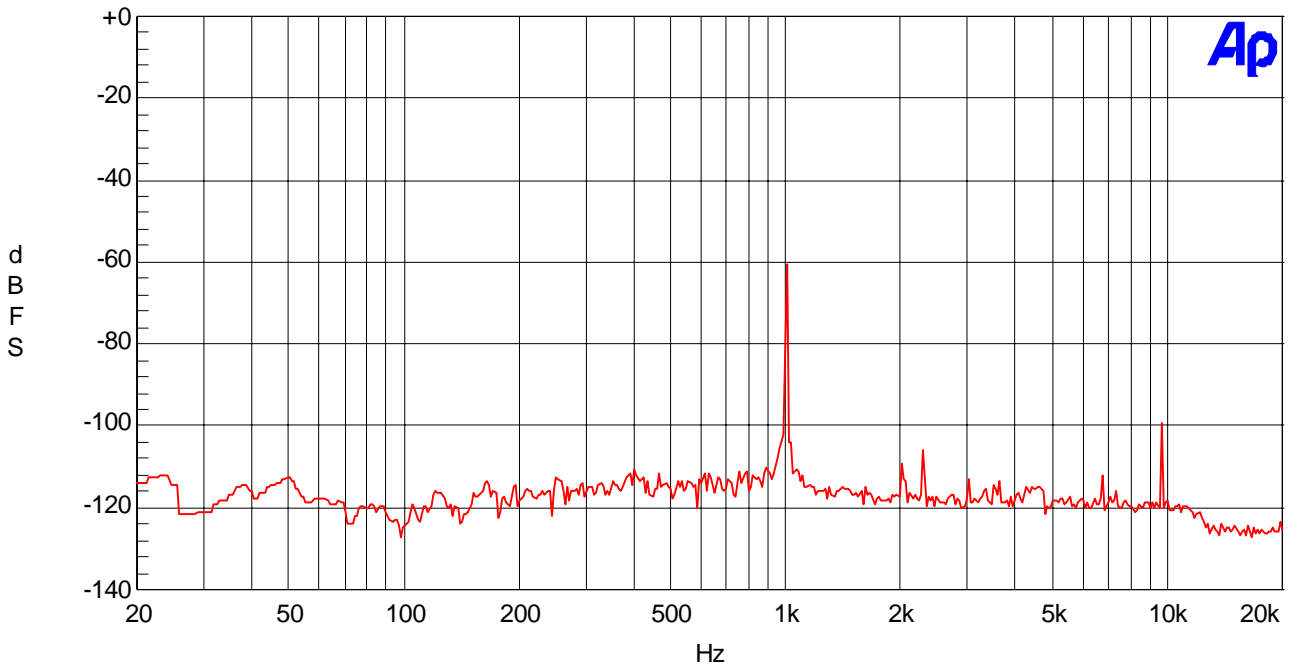

Figure 21. FFT Plot (-60dB)

AKM

04/19/06 18:18:25

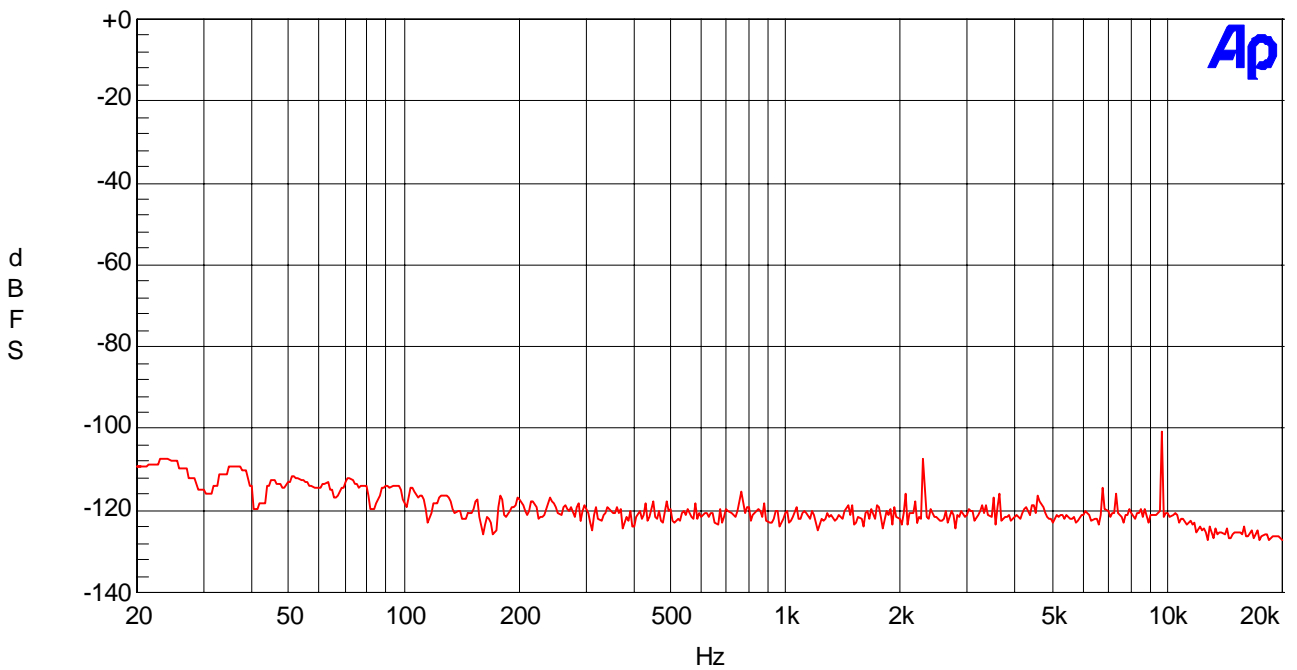

Figure 22. FFT Plot (no input)

Revision History

Date (YY/MM/DD)	Manual Revision	Board Revision	Reason	Contents
05/06/03	KM079200	0	First edition	
06/04/20	KM079201	1	Revised	Modified for readability and measurement test data was added to document.
06/08/02	KM079202	1	Error correct	P.3:DIP switch (SW4) setting was revised.

IMPORTANT NOTICE

- These products and their specifications are subject to change without notice. Before considering any use or application, consult the Asahi Kasei Microsystems Co., Ltd. (AKM) sales office or authorized distributor concerning their current status.
- AKM assumes no liability for infringement of any patent, intellectual property, or other right in the application or use of any information contained herein.
- Any export of these products, or devices or systems containing them, may require an export license or other official approval under the law and regulations of the country of export pertaining to customs and tariffs, currency exchange, or strategic materials.
- AKM products are neither intended nor authorized for use as critical components in any safety, life support, or other hazard related device or system, and AKM assumes no responsibility relating to any such use, except with the express written consent of the Representative Director of AKM. As used here:
 - (a) A hazard related device or system is one designed or intended for life support or maintenance of safety or for applications in medicine, aerospace, nuclear energy, or other fields, in which its failure to function or perform may reasonably be expected to result in loss of life or in significant injury or damage to person or property.
 - (b) A critical component is one whose failure to function or perform may reasonably be expected to result, whether directly or indirectly, in the loss of the safety or effectiveness of the device or system containing it, and which must therefore meet very high standards of performance and reliability.
- It is the responsibility of the buyer or distributor of an AKM product who distributes, disposes of, or otherwise places the product with a third party to notify that party in advance of the above content and conditions, and the buyer or distributor agrees to assume any and all responsibility and liability for and hold AKM harmless from any and all claims arising from the use of said product in the absence of such notification.

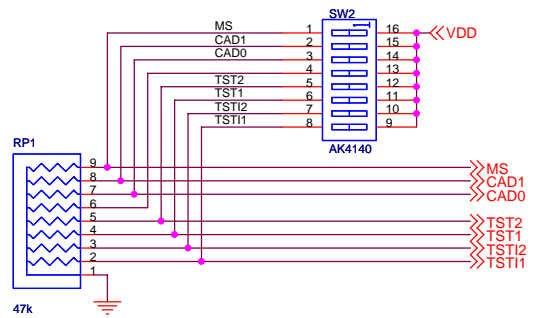
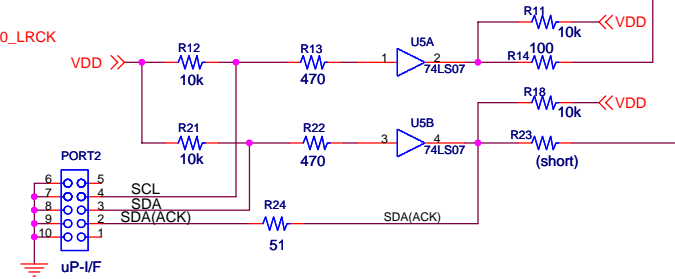
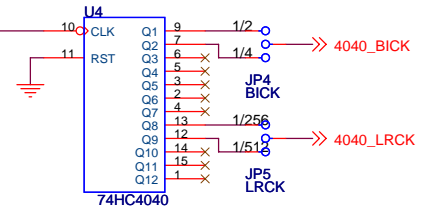
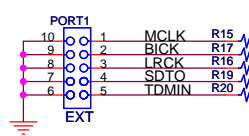
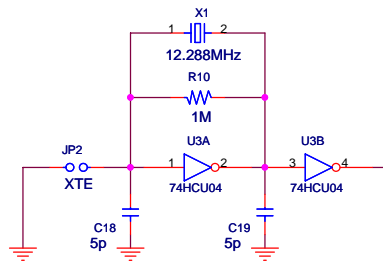
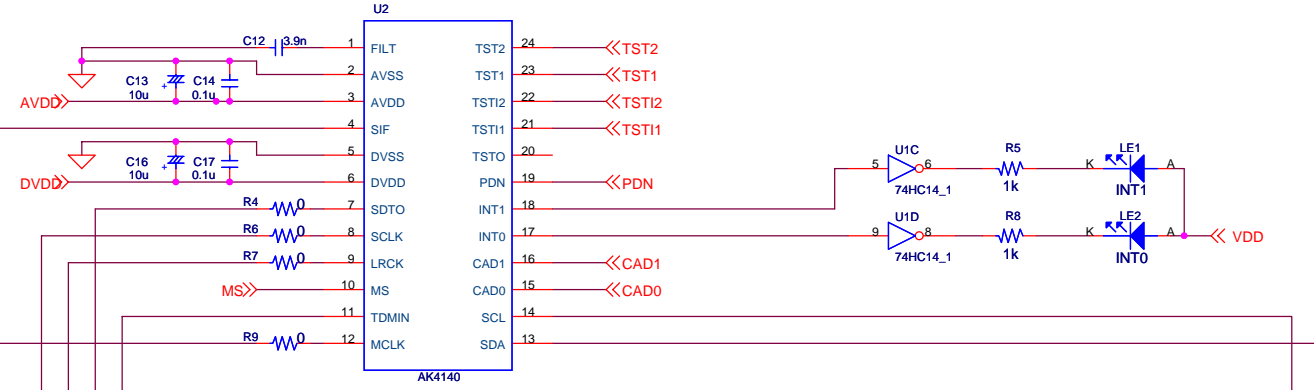
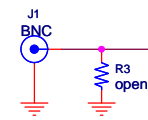
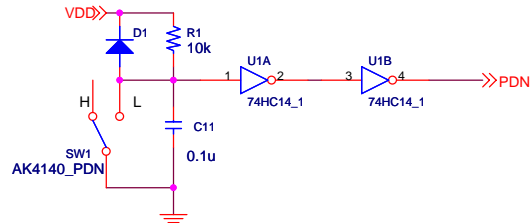
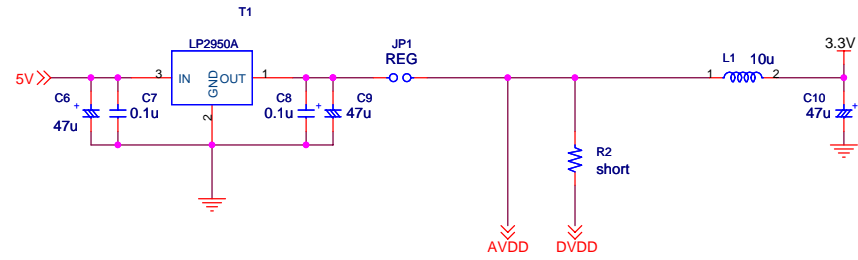
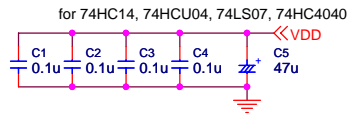

Title		AKD4140-A	
Size	Document Number	AK4140	
A3		Rev	0
Date:	Friday, April 22, 2005	Sheet	1 of 2

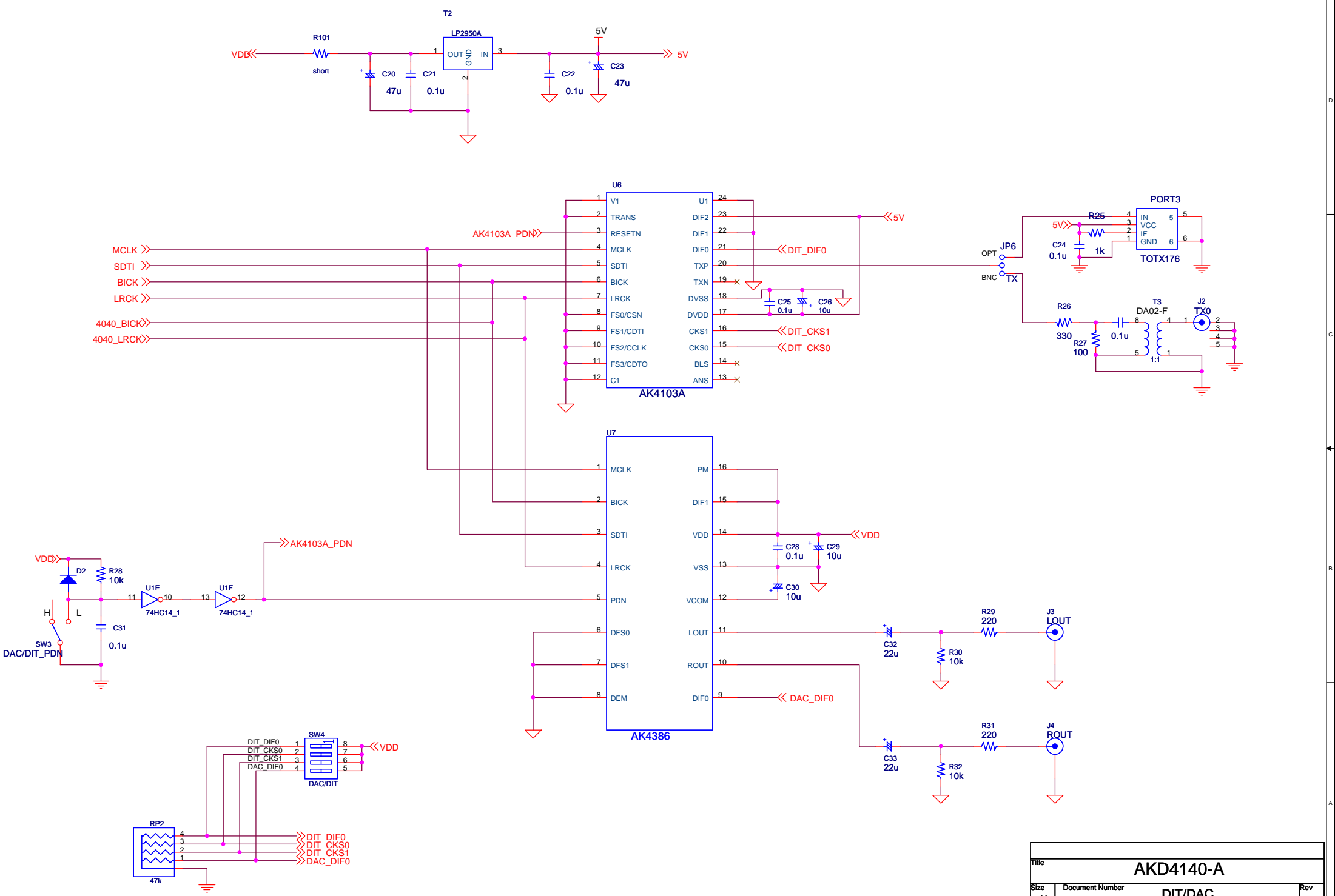

Title		AKD4140-A	
Size	Document Number	DIT/DAC	
A3			
Date:	Friday, May 27, 2005	Sheet	2 of 2
		Rev	0

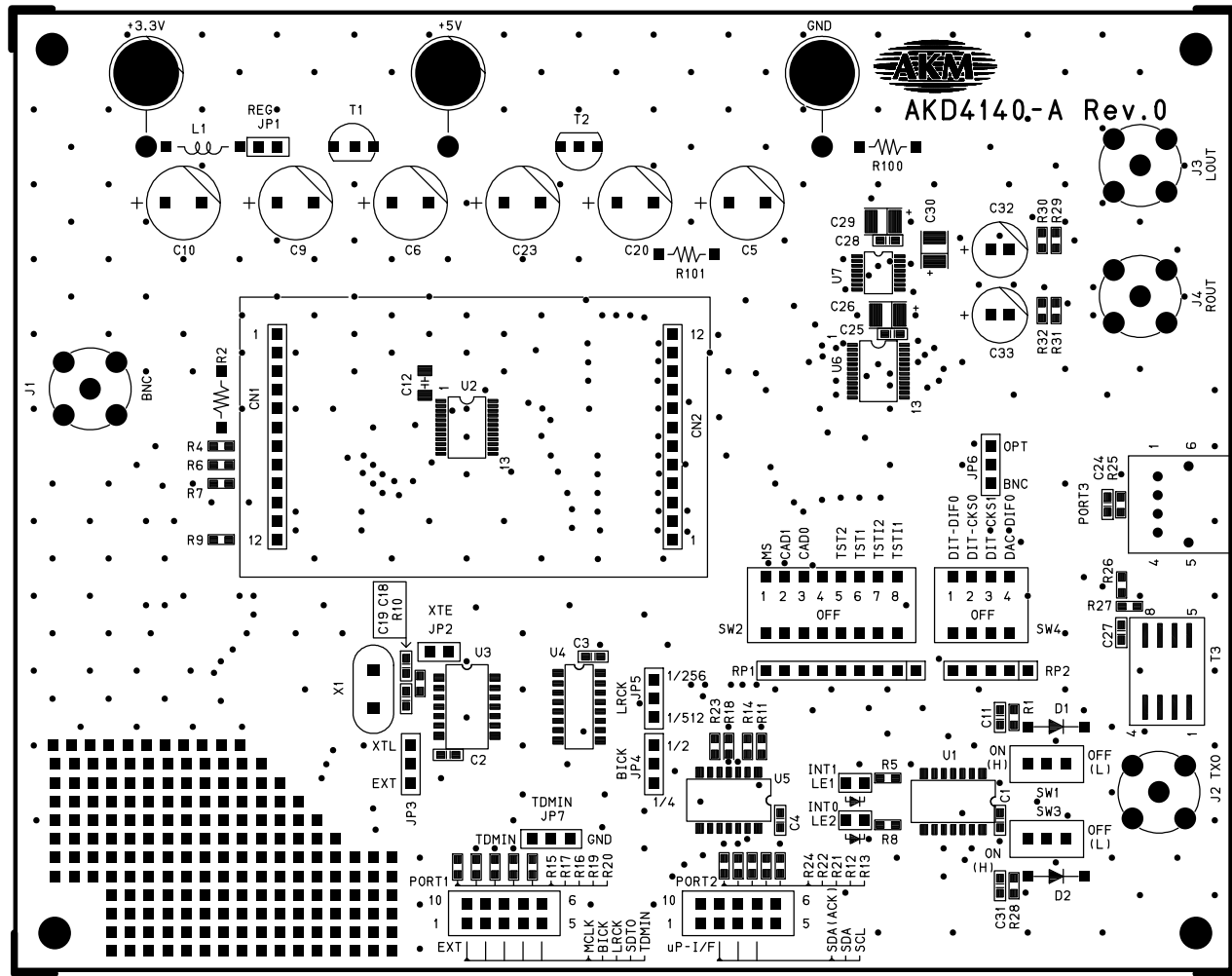

AKD4140-A L1 SILK

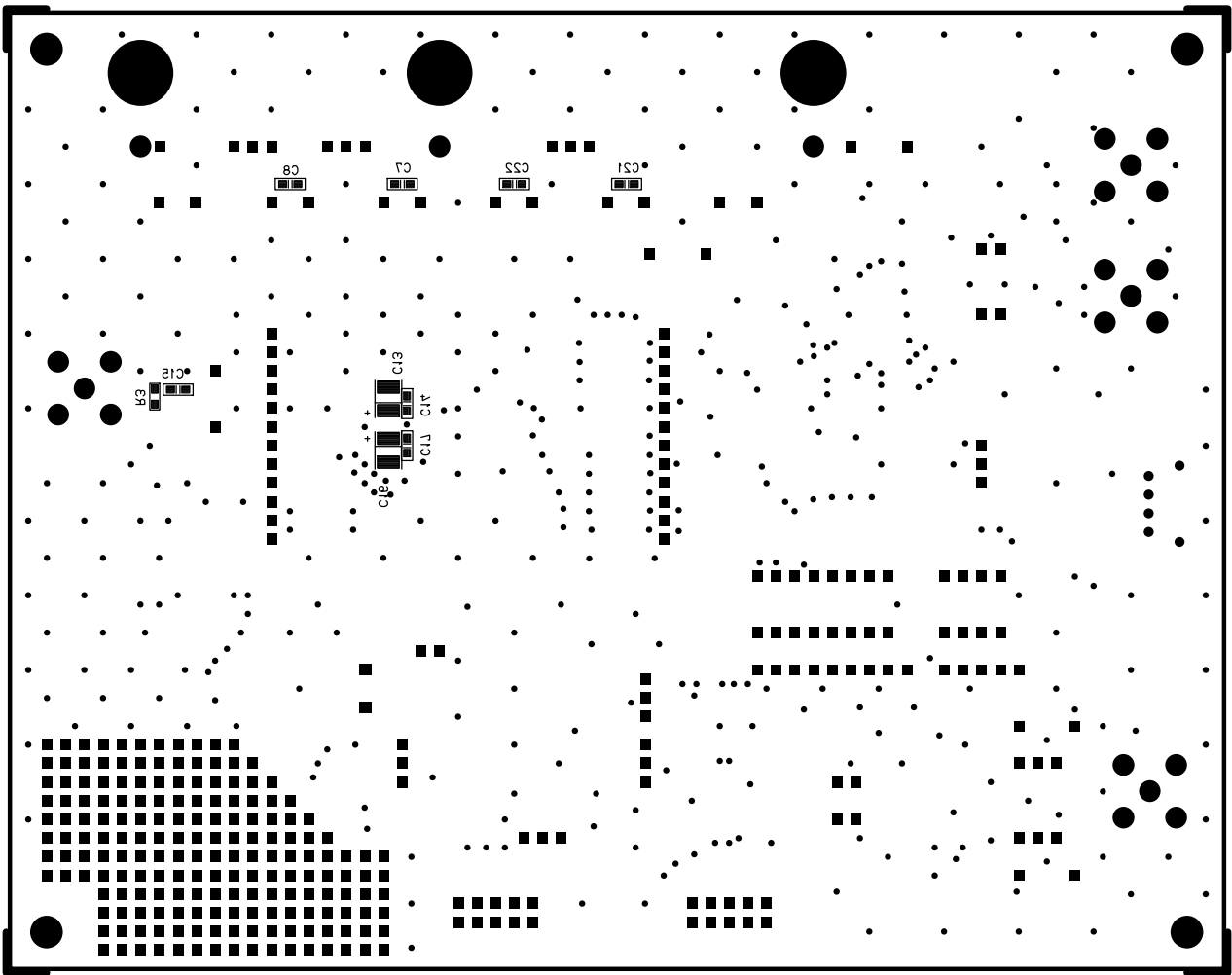

AKD4140-A L3 SILK

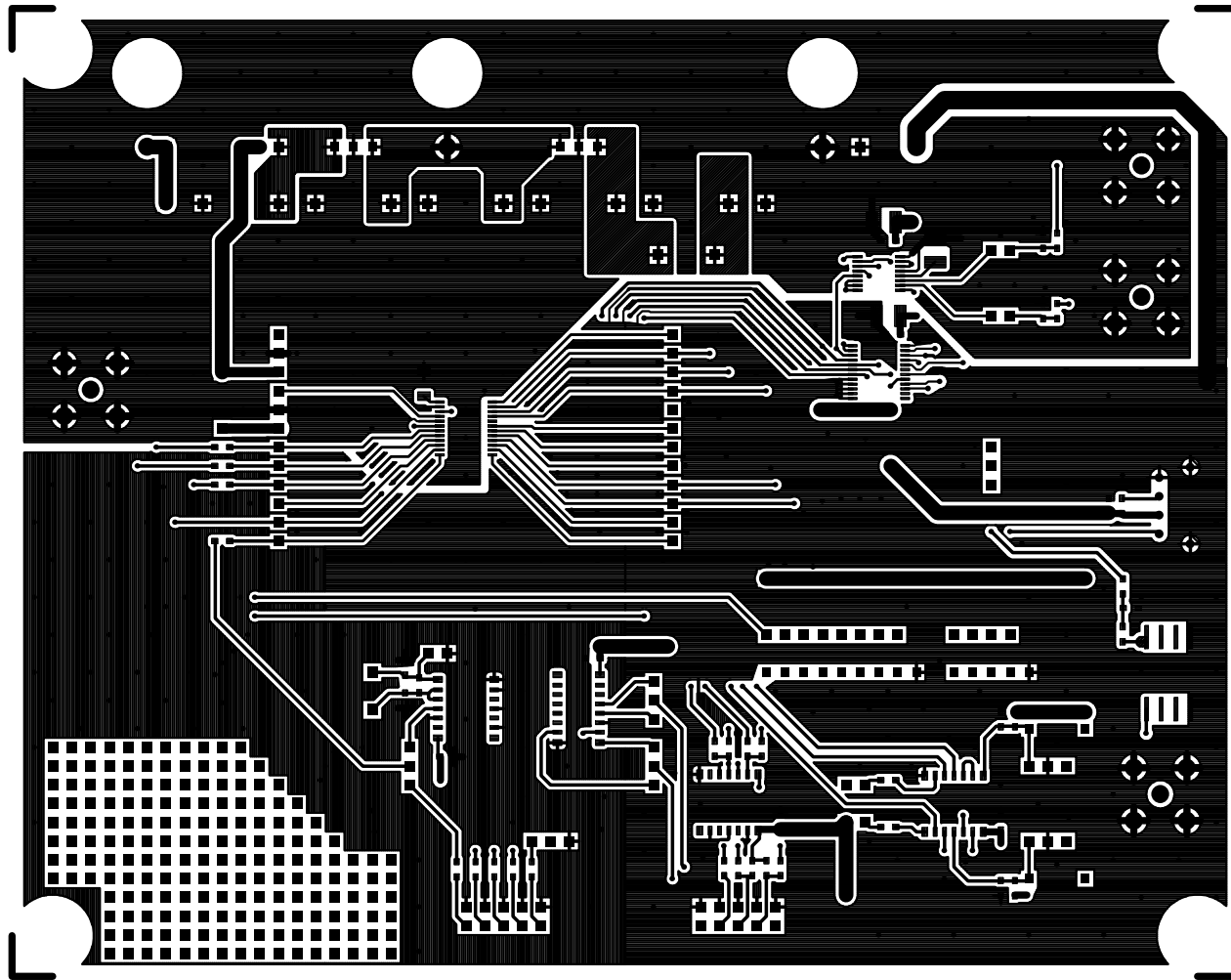

AKD4140-A L1

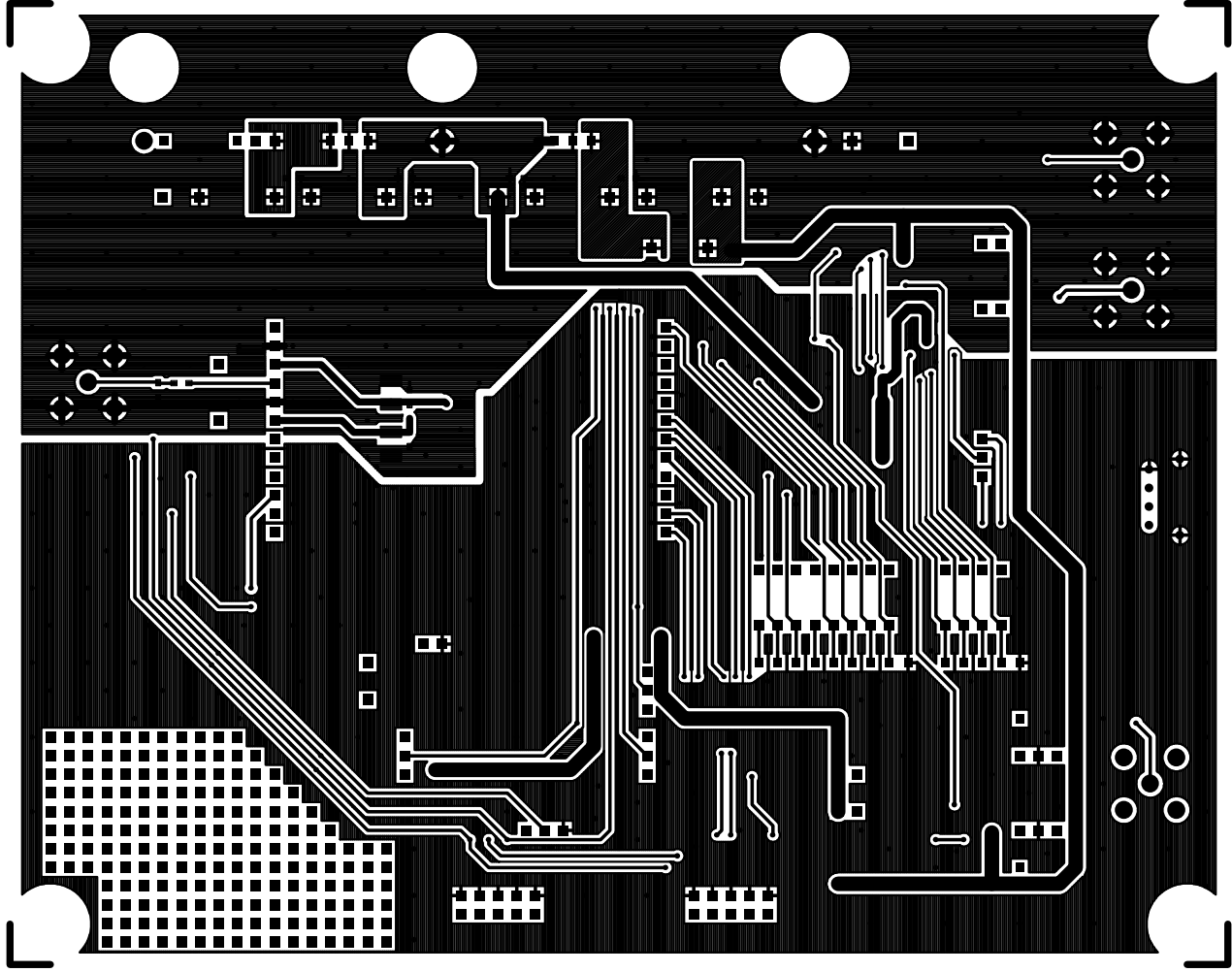

AKD4140-A JS