

SKiiP 37NAB065V1

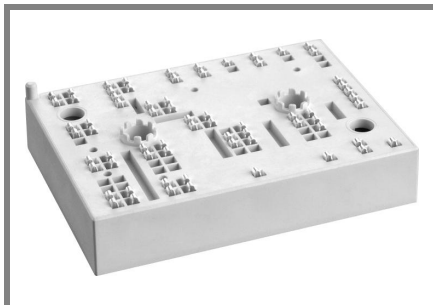

MiniSKiiP® 3

3-phase bridge rectifier +
brake chopper + 3-phase
bridge inverter
SKiiP 37NAB065V1

Features

- Ultrafast NPT IGBTs
- Robust and soft freewheeling diodes in CAL technology
- Highly reliable spring contacts for electrical connections
- UL recognised file no. E63532

Typical Applications

- Inverter up to 18 kVA
- Typical motor power 7,5 kW

Remarks

- V_{CEsat} , V_F = chip level value

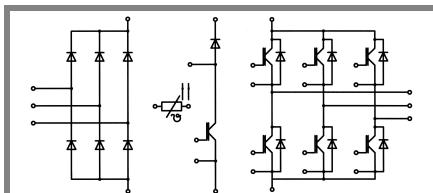

NAB

| Absolute Maximum Ratings | | $T_s = 25\text{ °C}$, unless otherwise specified | |
|----------------------------------|--|---|------------------|
| Symbol | Conditions | Values | Units |
| IGBT - Inverter, Chopper | | | |
| V_{CES} | $T_s = 25\text{ (70) °C}$ $t_p \leq 1\text{ ms}$ | 600 | V |
| I_C | | 66 (50) | A |
| I_{CRM} | | 120 | A |
| V_{GES} | | ± 20 | V |
| T_j | | - 40 ... + 150 | °C |
| Diode - Inverter, Chopper | | | |
| I_F | $T_s = 25\text{ (70) °C}$ $t_p \leq 1\text{ ms}$ | 66 (50) | A |
| I_{FRM} | | 120 | A |
| T_j | | - 40 ... + 150 | °C |
| Diode - Rectifier | | | |
| V_{RRM} | $T_s = 70\text{ °C}$ $t_p = 10\text{ ms, sin } 180\text{ °, } T_j = 25\text{ °C}$ $t_p = 10\text{ ms, sin } 180\text{ °, } T_j = 25\text{ °C}$ | 800 | V |
| I_F | | 61 | A |
| I_{FSM} | | 700 | A |
| i^2t | | 2400 | A ² s |
| T_j | | - 40 ... + 150 | °C |
| I_{tRMS} | per power terminal (20 A / spring) | 80 | A |
| T_{stg} | $T_{op} \leq T_{stg}$ | - 40 ... + 125 | °C |
| V_{isol} | AC, 1 min. | 2500 | V |

| Characteristics | | $T_s = 25\text{ °C}$, unless otherwise specified | | | |
|----------------------------------|---|---|------------|-----------|-------|
| Symbol | Conditions | min. | typ. | max. | Units |
| IGBT - Inverter, Chopper | | | | | |
| V_{CEsat} | $I_{Cnom} = 60\text{ A, } T_j = 25\text{ (125) °C}$ | | 2 (2,2) | 2,5 (2,7) | V |
| $V_{GE(th)}$ | $V_{GE} = V_{CE}, I_C = 1\text{ mA}$ | 3 | 4 | 5 | V |
| $V_{CE(TO)}$ | $T_j = 25\text{ (125) °C}$ | | 1,2 (1,1) | 1,3 (1,2) | V |
| r_T | $T_j = 25\text{ (125) °C}$ | | 13 (18) | 20 (25) | mΩ |
| C_{ies} | $V_{CE} = 25\text{ V, } V_{GE} = 0\text{ V, } f = 1\text{ MHz}$ | | 3,3 | | nF |
| C_{oes} | $V_{CE} = 25\text{ V, } V_{GE} = 0\text{ V, } f = 1\text{ MHz}$ | | 0,7 | | nF |
| C_{res} | $V_{CE} = 25\text{ V, } V_{GE} = 0\text{ V, } f = 1\text{ MHz}$ | | 0,8 | | nF |
| $R_{th(j-s)}$ | per IGBT | | 0,65 | | K/W |
| $t_{d(on)}$ | under following conditions | | 35 | | ns |
| t_r | $V_{CC} = 300\text{ V, } V_{GE} = \pm 15\text{ V}$ | | 35 | | ns |
| $t_{d(off)}$ | $I_{Cnom} = 60\text{ A, } T_j = 125\text{ °C}$ | | 310 | | ns |
| t_f | $R_{Gon} = R_{Goff} = 15\text{ Ω}$ | | 20 | | ns |
| E_{on} | inductive load | | 1,8 | | mJ |
| E_{off} | | | 1,4 | | mJ |
| Diode - Inverter, Chopper | | | | | |
| $V_F = V_{EC}$ | $I_{Fnom} = 60\text{ A, } T_j = 25\text{ (125) °C}$ | | 1,5 (1,5) | 1,8 (1,8) | V |
| $V_{(TO)}$ | $T_j = 25\text{ (125) °C}$ | | 1 (0,9) | 1,1 (1) | V |
| r_T | $T_j = 25\text{ (125) °C}$ | | 9 (10) | 12 (14) | mΩ |
| $R_{th(j-s)}$ | per diode | | 1 | | K/W |
| I_{RRM} | under following conditions | | 80 | | A |
| Q_{rr} | $I_{Fnom} = 60\text{ A, } V_R = 300\text{ V}$ | | 7,5 | | μC |
| E_{rr} | $V_{GE} = 0\text{ V, } T_j = 125\text{ °C}$ $di_F/dt = 3500\text{ A/μs}$ | | 1,7 | | mJ |
| Diode - Rectifier | | | | | |
| V_F | $I_{Fnom} = 35\text{ A, } T_j = 25\text{ °C}$ | | 1,1 | | V |
| $V_{(TO)}$ | $T_j = 150\text{ °C}$ | | 0,8 | | V |
| r_T | $T_j = 150\text{ °C}$ | | 11 | | mΩ |
| $R_{th(j-s)}$ | per diode | | 0,9 | | K/W |
| Temperature Sensor | | | | | |
| R_{ts} | 3 %, $T_r = 25\text{ (100) °C}$ | | 1000(1670) | | Ω |
| Mechanical Data | | | | | |
| w | | | 95 | | g |
| M_s | Mounting torque | 2 | | 2,5 | Nm |

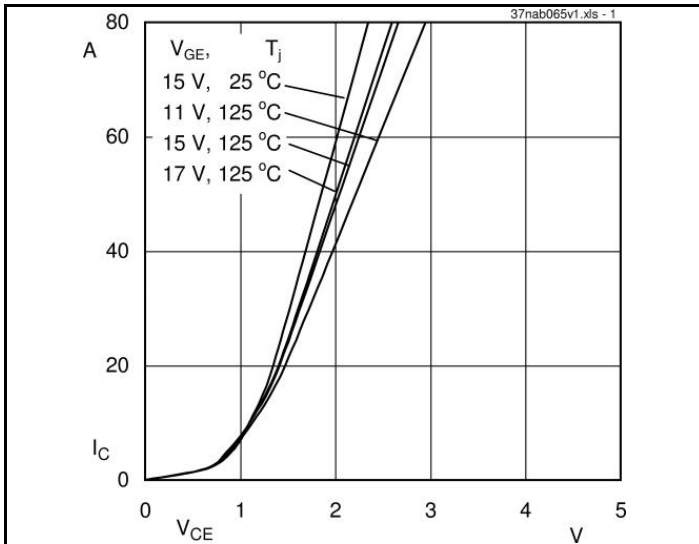

Fig. 1 Typ. output characteristic

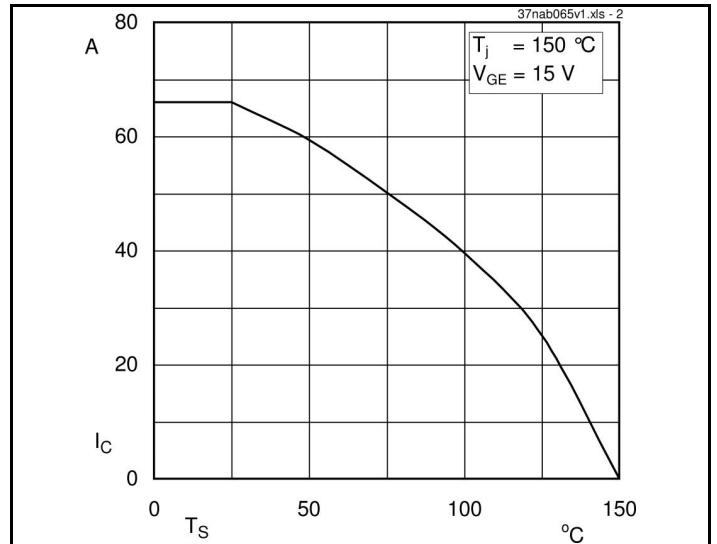

Fig. 2 Typ. rated current vs. temperature

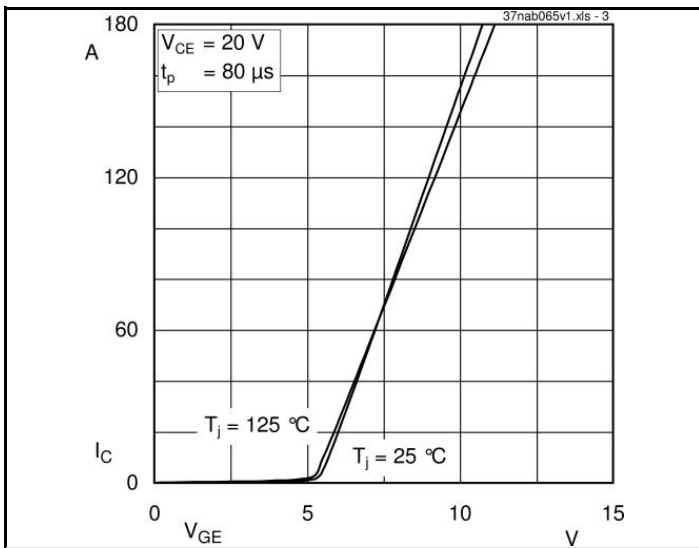

Fig. 3 Typ. transfer characteristic

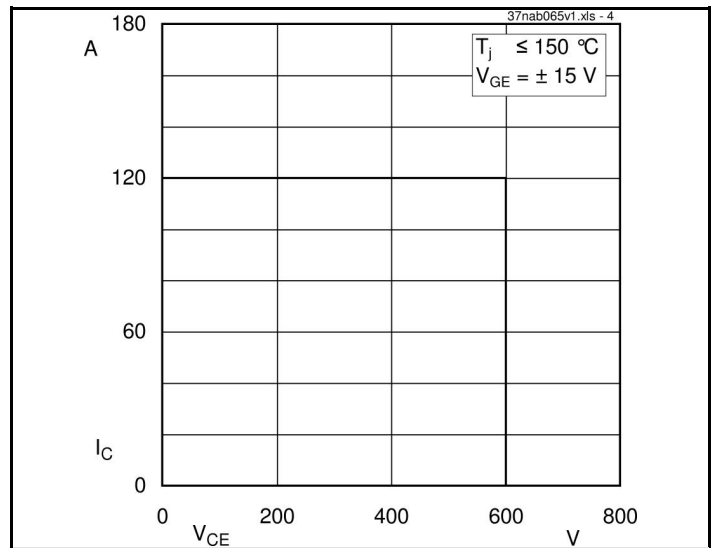

Fig. 4 Reverse bias safe operating area

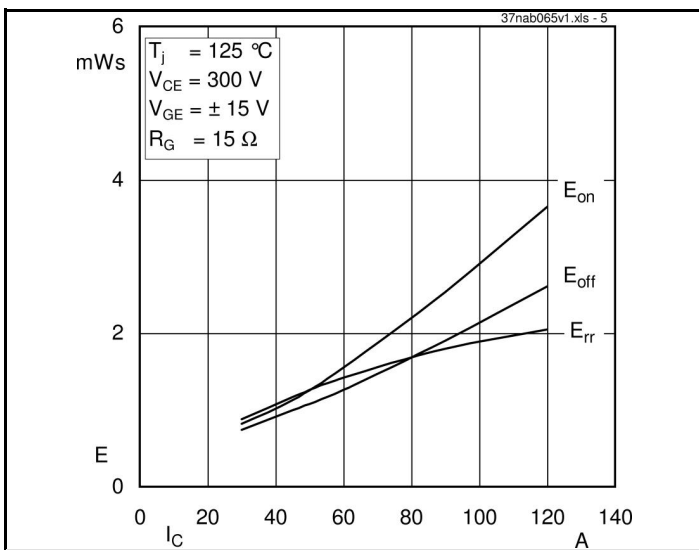

Fig. 5 Typ. Turn-on /-off energy = $f(I_C)$

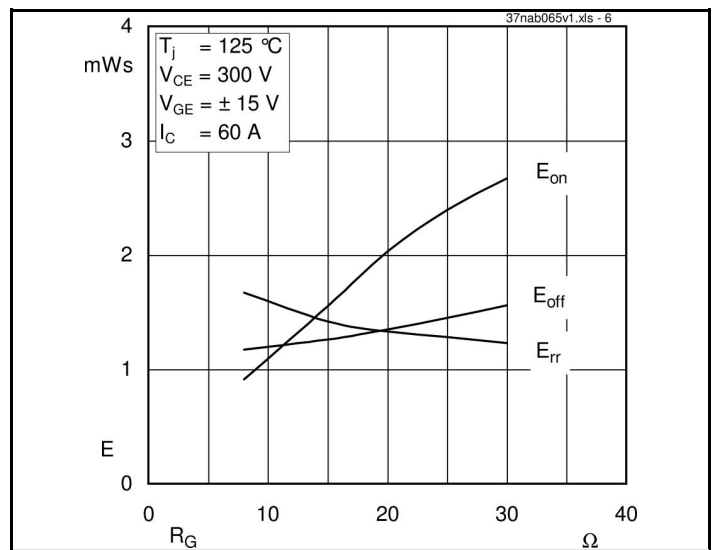
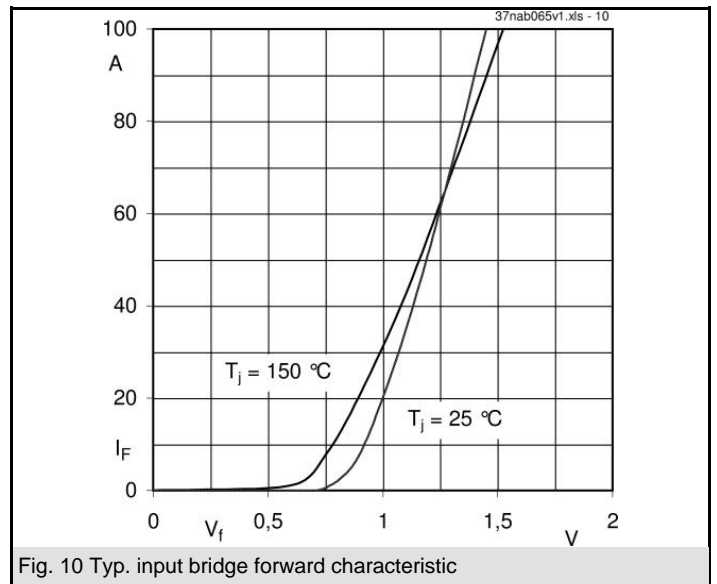
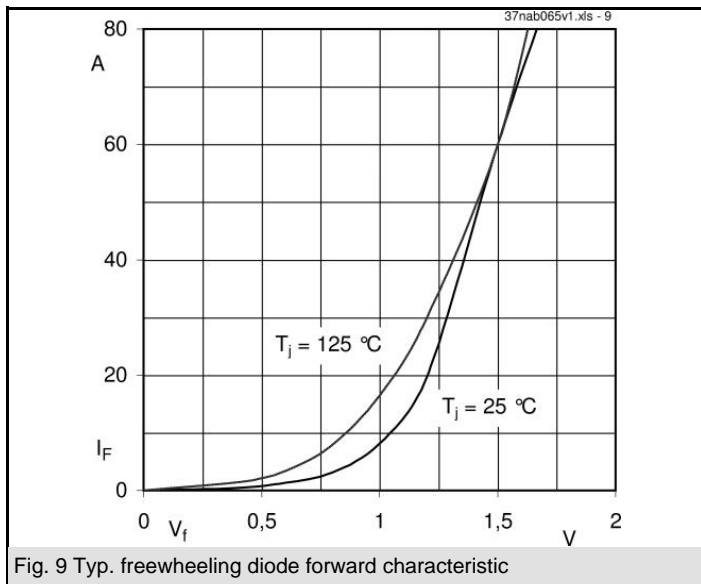
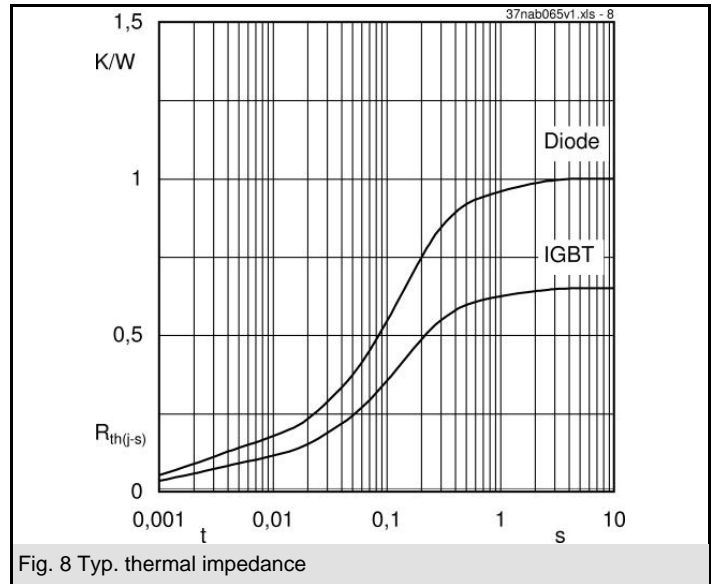
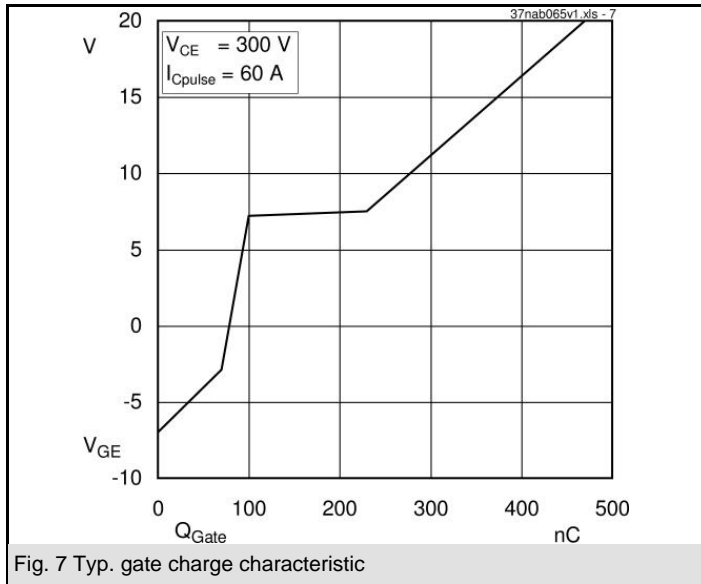
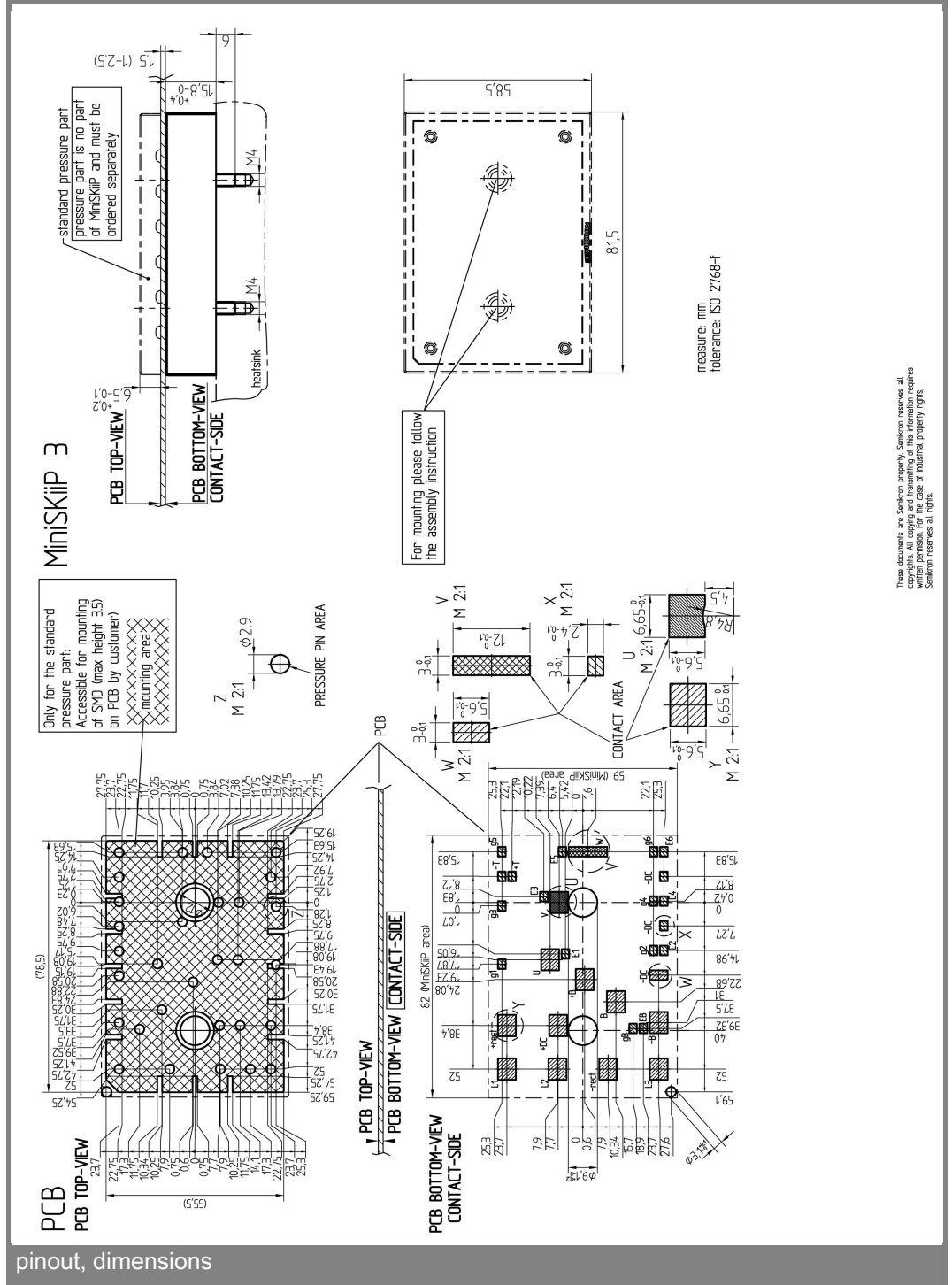
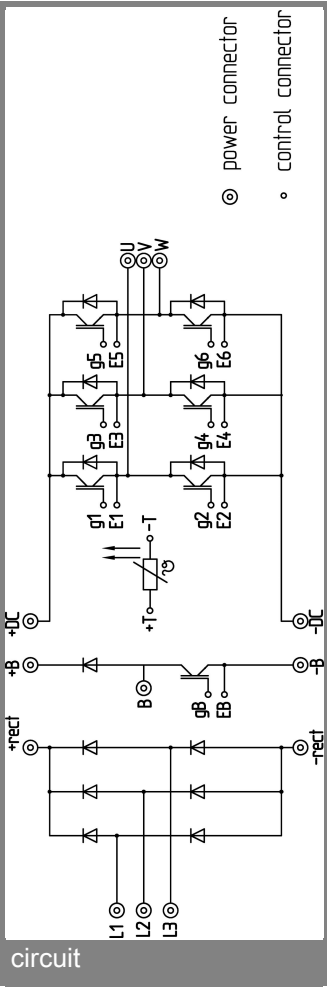

Fig. 6 Typ. Turn-on /-off energy = $f(R_G)$





These documents are Semikron property. Semikron reserves all copyrights. All copying and releasing of this information requires written permission. In the case of industrial property rights, Semikron reserves all rights.