

BUK7619-100B

N-channel TrenchMOS standard level FET

Rev. 01 — 10 October 2007

Product data sheet

1. Product profile

1.1 General description

N-channel enhancement mode power Field-Effect Transistor (FET) in a plastic package using NXP High Performance Automotive (HPA) TrenchMOS technology.

1.2 Features

- TrenchMOS technology
- 175 °C rated
- Q101 compliant
- Standard level compatible

1.3 Applications

- Automotive systems
- Motors, lamps and solenoids
- General purpose power switching
- 12 V, 24 V and 42 V loads.

1.4 Quick reference data

- $E_{DS(AL)S} \leq 222$ mJ
- $I_D \leq 64$ A
- $R_{DSon} = 17$ m Ω (typ)
- $P_{tot} \leq 200$ W

2. Pinning information

Table 1. Pinning

Pin	Description	Simplified outline	Symbol
1	gate (G)	<p>SOT404 (D2PAK)</p>	<p>mbb076</p>
2	drain (D)		
3	source (S)		
mb	mounting base; connected to drain (D)		

3. Ordering information

Table 2. Ordering information

Type number	Package		Version
	Name	Description	
BUK7619-100B	D2PAK	plastic single-ended surface-mounted package (D2PAK); 3-leads (one lead cropped)	SOT404

4. Limiting values

Table 3. Limiting values

In accordance with the Absolute Maximum Rating System (IEC 60134).

Symbol	Parameter	Conditions	Min	Max	Unit
V_{DS}	drain-source voltage		-	100	V
V_{DGR}	drain-gate voltage (DC)	$R_{GS} = 20 \text{ k}\Omega$	-	100	V
V_{GS}	gate-source voltage		-	± 20	V
I_D	drain current	$T_{sp} = 25 \text{ }^\circ\text{C}$; $V_{GS} = 10 \text{ V}$; see Figure 2 and 3	-	64	A
		$T_{sp} = 100 \text{ }^\circ\text{C}$; $V_{GS} = 10 \text{ V}$; see Figure 2	-	45	A
I_{DM}	peak drain current	$T_{mb} = 25 \text{ }^\circ\text{C}$; pulsed; $t_p \leq 10 \text{ }\mu\text{s}$; see Figure 3	-	256	A
P_{tot}	total power dissipation	$T_{mb} = 25 \text{ }^\circ\text{C}$; see Figure 1	-	200	W
T_{stg}	storage temperature		-55	+175	$^\circ\text{C}$
T_j	junction temperature		-55	+175	$^\circ\text{C}$
Source-drain diode					
I_{DR}	reverse drain current	$T_{mb} = 25 \text{ }^\circ\text{C}$	-	64	A
I_{DRM}	peak reverse drain current	$T_{mb} = 25 \text{ }^\circ\text{C}$; pulsed; $t_p \leq 10 \text{ }\mu\text{s}$	-	256	A
Avalanche ruggedness					
$E_{DS(AL)S}$	non-repetitive drain-source avalanche energy	unclamped inductive load; $I_D = 64 \text{ A}$; $V_{DS} \leq 100 \text{ V}$; $R_{GS} = 50 \text{ }\Omega$; $V_{GS} = 10 \text{ V}$; starting at $T_j = 25 \text{ }^\circ\text{C}$	-	222	mJ
$E_{DS(AL)R}$	repetitive drain-source avalanche energy		[1]	-	mJ

[1] Conditions:

- Maximum value not quoted. Repetitive rating defined in [Figure 16](#).
- Single-pulse avalanche rating limited by $T_{j(max)}$ of $175 \text{ }^\circ\text{C}$.
- Repetitive avalanche rating limited by an average junction temperature of $170 \text{ }^\circ\text{C}$.
- Refer to application note *AN10273* for further information.

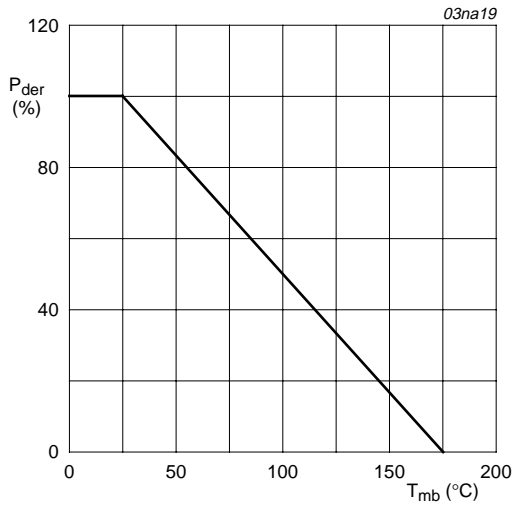

$$P_{der} = \frac{P_{tot}}{P_{tot(25^{\circ}C)}} \times 100\%$$

Fig 1. Normalized total power dissipation as a function of mounting base temperature

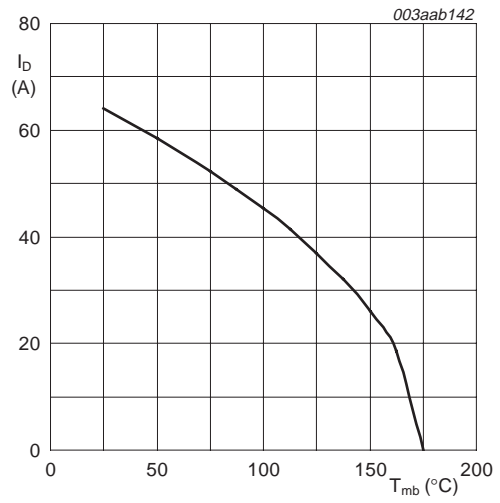

$V_{GS} \geq 10\text{ V}$

Fig 2. Continuous drain current as a function of mounting base temperature

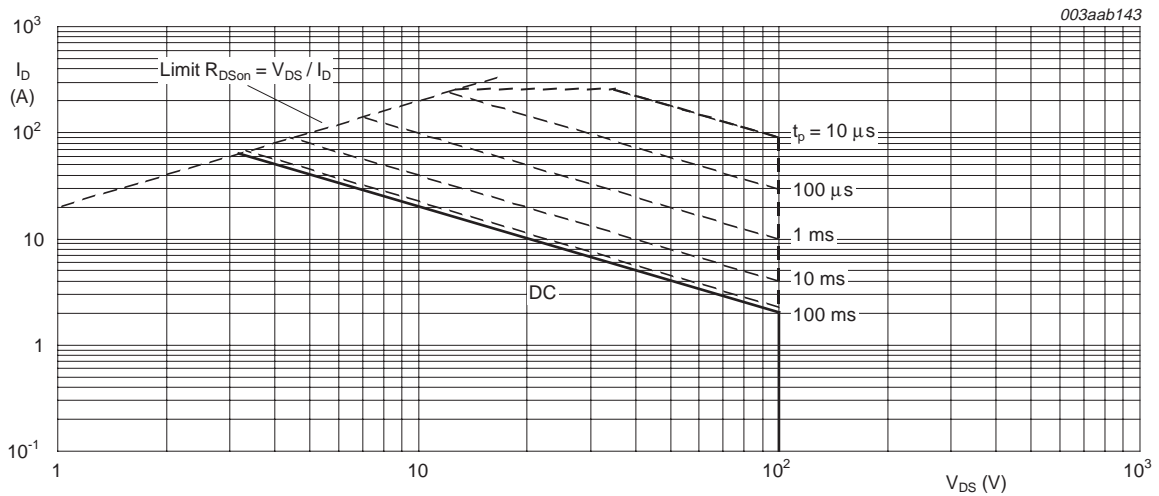

$T_{mb} = 25^{\circ}C$; I_{DM} is single pulse.

Fig 3. Safe operating area; continuous and peak drain currents as a function of drain-source voltage

5. Thermal characteristics

Table 4. Thermal characteristics

Symbol	Parameter	Conditions	Min	Typ	Max	Unit
$R_{th(j-mb)}$	thermal resistance from junction to mounting base		-	-	0.74	K/W
$R_{th(j-a)}$	thermal resistance from junction to ambient	mounted on a printed-circuit board; minimum footprint	-	50	-	K/W

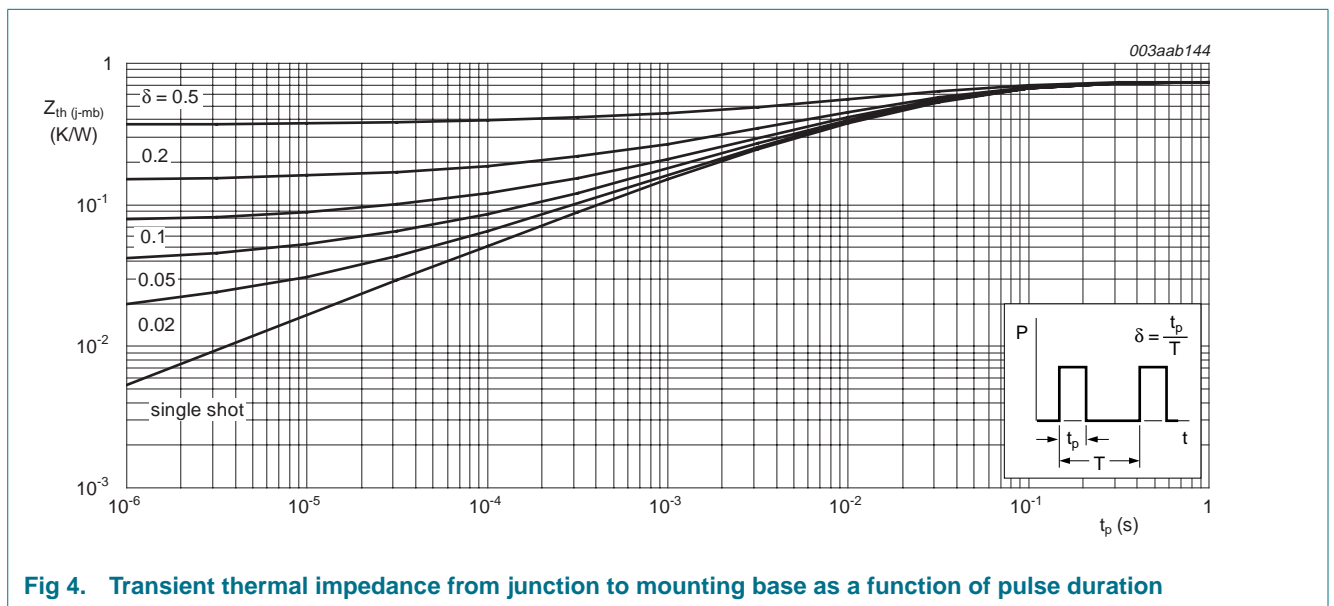
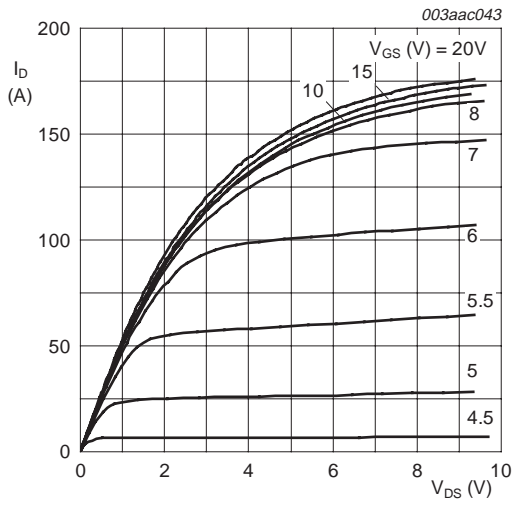

Fig 4. Transient thermal impedance from junction to mounting base as a function of pulse duration

6. Characteristics

Table 5. Characteristics
T_j = 25 °C unless otherwise specified.

Symbol	Parameter	Conditions	Min	Typ	Max	Unit
Static characteristics						
V _{(BR)DSS}	drain-source breakdown voltage	I _D = 250 μA; V _{GS} = 0 V				
		T _j = 25 °C	100	-	-	V
		T _j = -55 °C	89	-	-	V
V _{GS(th)}	gate-source threshold voltage	I _D = 1 mA; V _{DS} = V _{GS} ; see Figure 9 and 10				
		T _j = 25 °C	2	3	4	V
		T _j = 175 °C	1	-	-	V
		T _j = -55 °C	-	-	4.4	V
I _{DSS}	drain leakage current	V _{DS} = 100 V; V _{GS} = 0 V				
		T _j = 25 °C	-	0.02	1	μA
		T _j = 175 °C	-	-	500	μA
I _{GSS}	gate leakage current	V _{GS} = ±20 V; V _{DS} = 0 V	-	2	100	nA
R _{DS(on)}	drain-source on-state resistance	V _{GS} = 10 V; I _D = 25 A; see Figure 7 and 8				
		T _j = 25 °C	-	17	19	mΩ
		T _j = 175 °C	-	-	49	mΩ
Dynamic characteristics						
Q _{G(tot)}	total gate charge	I _D = 25 A; V _{DD} = 80 V; V _{GS} = 10 V; see Figure 14	-	53	-	nC
Q _{GS}	gate-source charge		-	11	-	nC
Q _{GD}	gate-drain charge		-	27	-	nC
C _{iss}	input capacitance	V _{GS} = 0 V; V _{DS} = 25 V; f = 1 MHz; see Figure 12	-	2555	3400	pF
C _{oss}	output capacitance		-	340	480	pF
C _{rss}	reverse transfer capacitance		-	84	115	pF
t _{d(on)}	turn-on delay time	V _{DS} = 30 V; R _L = 1.2 Ω;	-	19	-	ns
t _r	rise time	V _{GS} = 10 V; R _G = 10 Ω	-	45	-	ns
t _{d(off)}	turn-off delay time		-	85	-	ns
t _f	fall time		-	34	-	ns
Source-drain diode						
V _{SD}	source-drain voltage	I _S = 25 A; V _{GS} = 0 V; see Figure 15	-	0.85	1.2	V
t _{rr}	reverse recovery time	I _S = 20 A; di _S /dt = -100 A/μs;	-	116	-	ns
Q _r	recovered charge	V _{GS} = 0 V; V _R = 30 V	-	130	-	nC



$T_j = 25\text{ °C}$

Fig 5. Output characteristics: drain current as a function of drain-source voltage; typical values

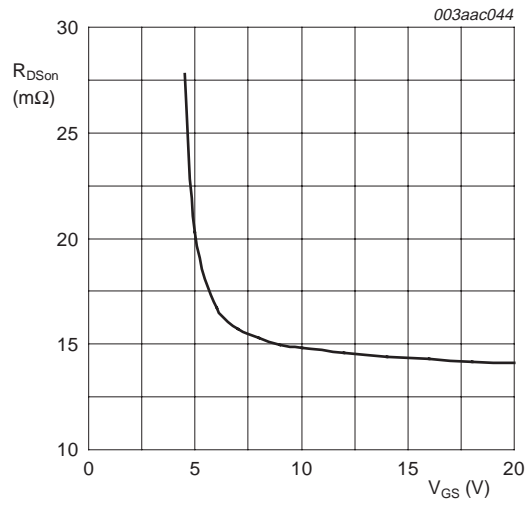

$T_j = 25\text{ °C}; I_D = 10\text{ A}$

Fig 6. Drain-source on-state resistance as a function of gate-source voltage; typical values

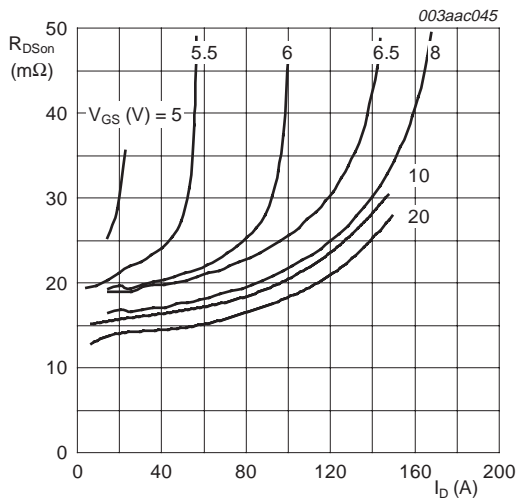

$T_j = 25\text{ °C}$

Fig 7. Drain-source on-state resistance as a function of drain current; typical values

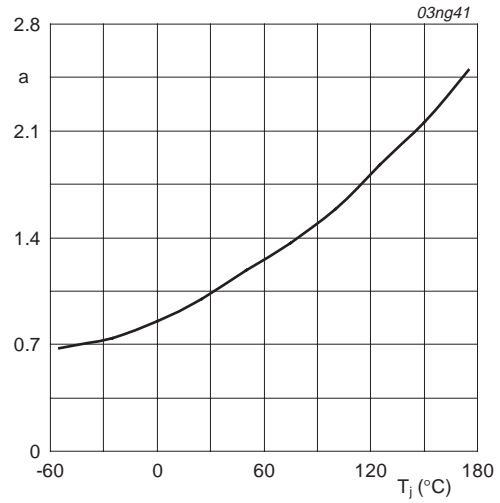

$$a = \frac{R_{DSon}}{R_{DSon(25\text{°C})}}$$

Fig 8. Normalized drain-source on-state resistance factor as a function of junction temperature

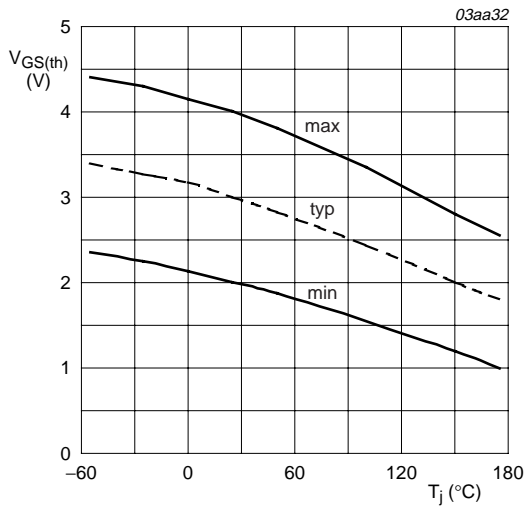

$I_D = 1 \text{ mA}; V_{DS} = V_{GS}$

Fig 9. Gate-source threshold voltage as a function of junction temperature

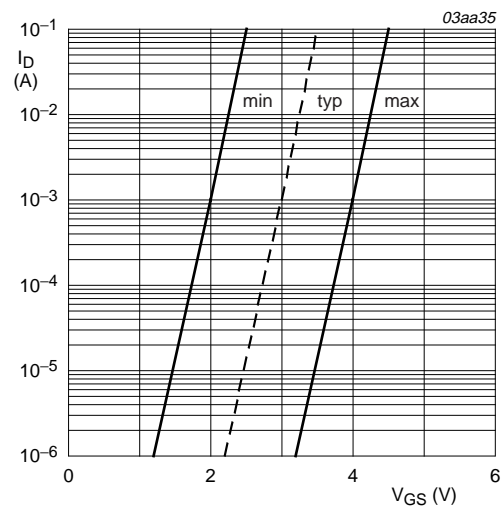

$T_j = 25 \text{ }^{\circ}C; V_{DS} = V_{GS}$

Fig 10. Sub-threshold drain current as a function of gate-source voltage

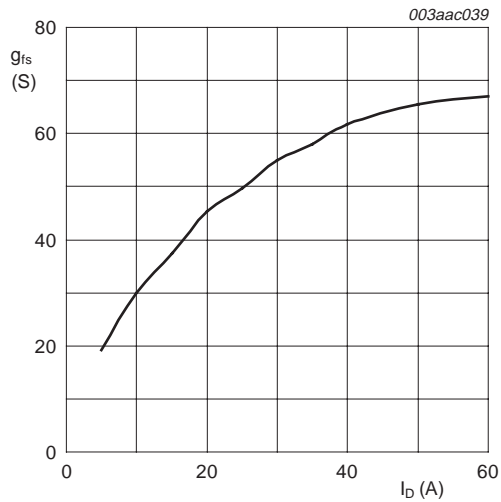

$T_j = 25 \text{ }^{\circ}C; V_{DS} = 25 \text{ V}$

Fig 11. Forward transconductance as a function of drain current; typical values

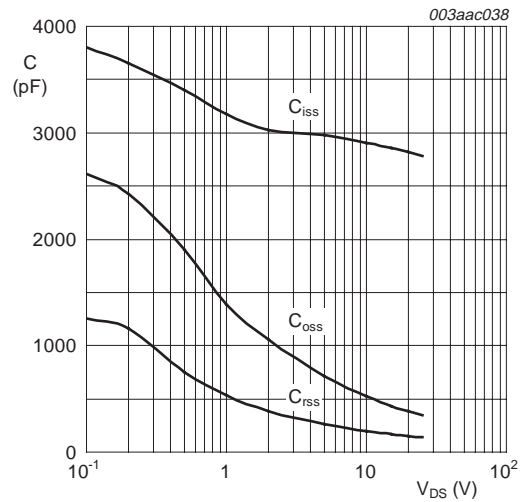

$V_{GS} = 0 \text{ V}; f = 1 \text{ MHz}$

Fig 12. Input, output and reverse transfer capacitances as a function of drain-source voltage; typical values

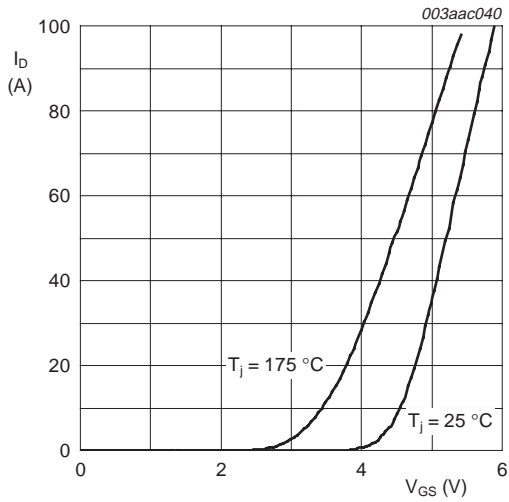

$V_{DS} = 25 \text{ V}$

Fig 13. Transfer characteristics: drain current as a function of gate-source voltage; typical values

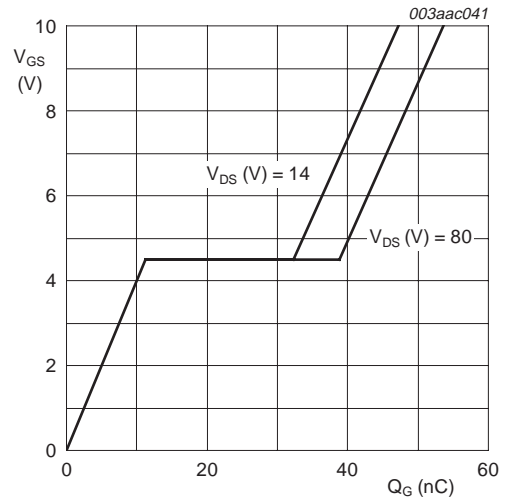

$T_j = 25 \text{ °C}; I_D = 25 \text{ A}$

Fig 14. Gate-source voltage as a function of gate charge; typical values

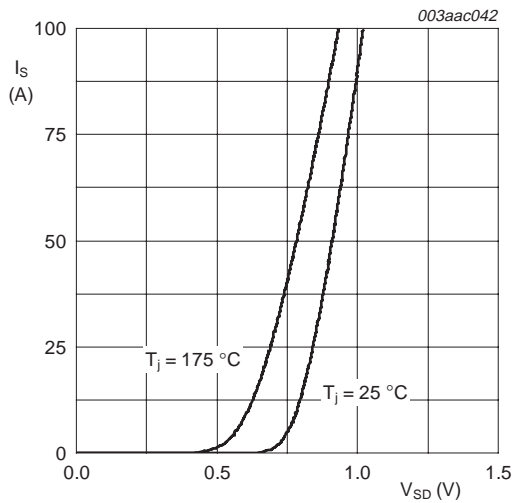

$V_{GS} = 0 \text{ V}$

Fig 15. Source (diode forward) current as a function of source-drain (diode forward) voltage; typical values

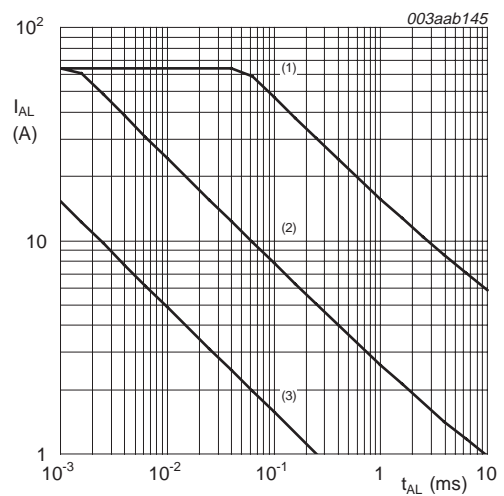

See [Table note 1](#) of [Table 3](#) Limiting values.

- (1) Single-pulse; $T_j = 25 \text{ °C}$.
- (2) Single-pulse; $T_j = 125 \text{ °C}$.
- (3) Repetitive.

Fig 16. Single-pulse and repetitive avalanche rating; avalanche current as a function of avalanche time

7. Package outline

Plastic single-ended surface-mounted package (D2PAK); 3 leads (one lead cropped)

SOT404

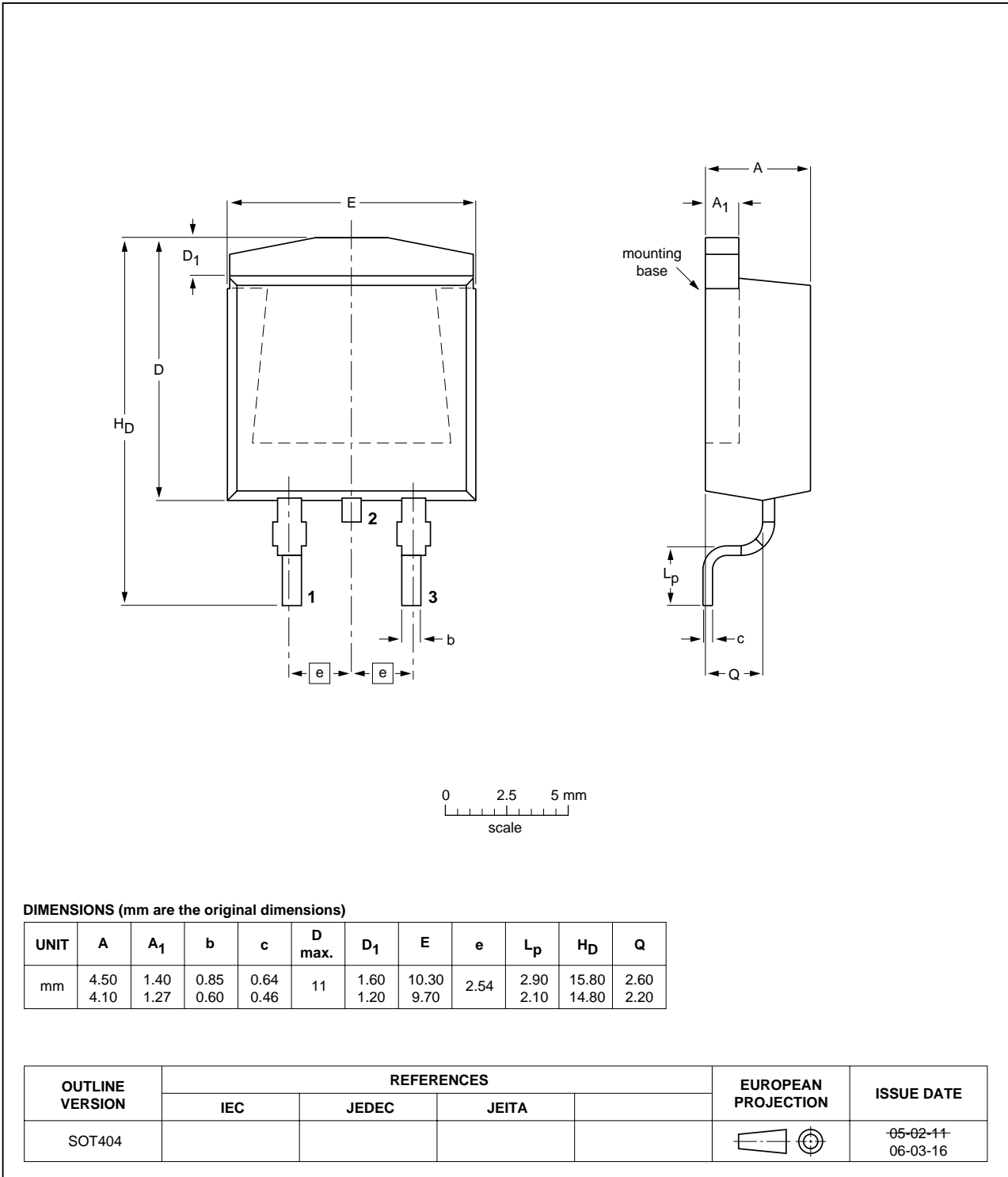
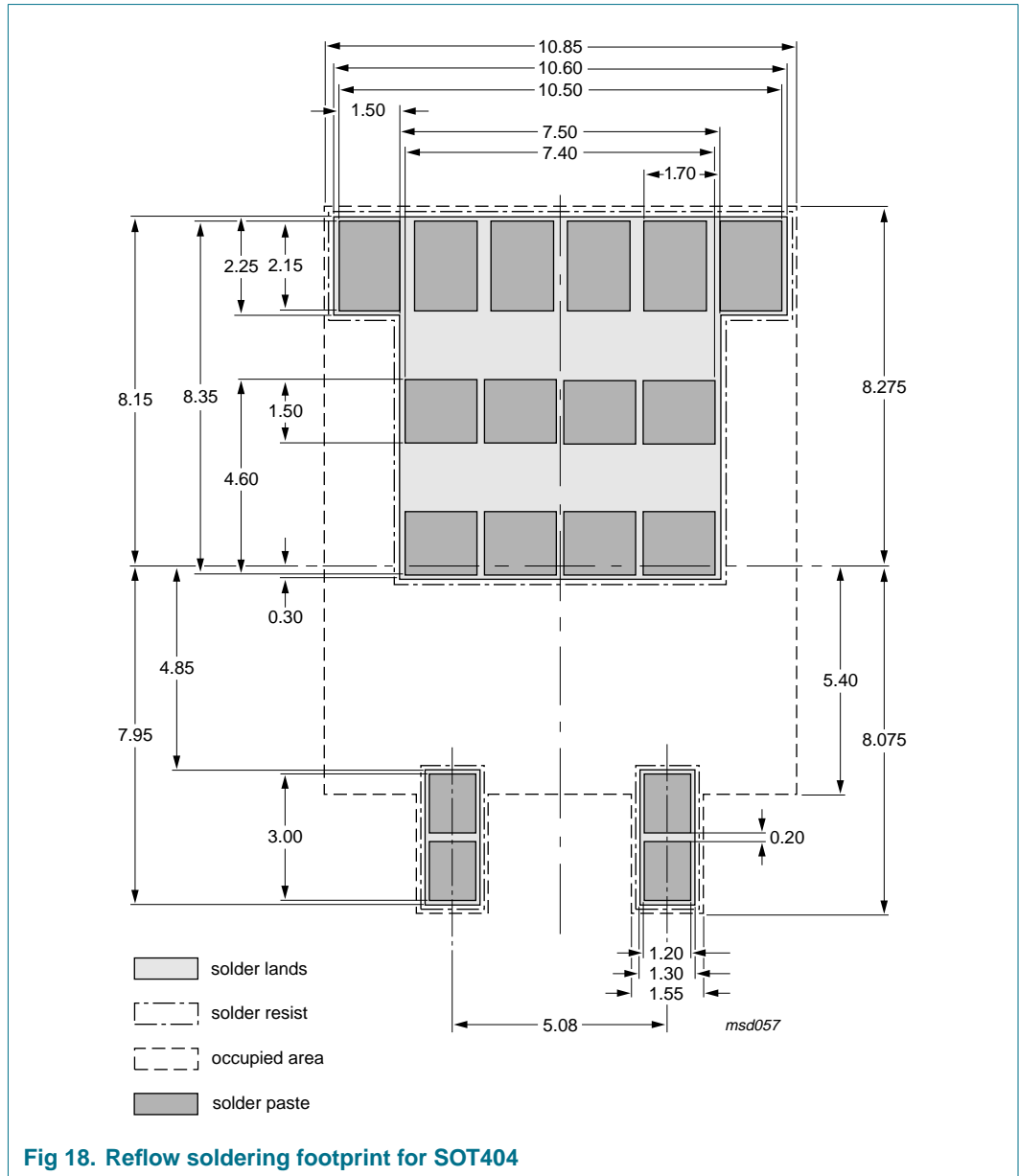

Fig 17. Package outline SOT404 (D2PAK)

8. Soldering



9. Revision history

Table 6. Revision history

Document ID	Release date	Data sheet status	Change notice	Supersedes
BUK7619-100B_1	20071010	Product data sheet	-	-

10. Legal information

10.1 Data sheet status

Document status ^{[1][2]}	Product status ^[3]	Definition
Objective [short] data sheet	Development	This document contains data from the objective specification for product development.
Preliminary [short] data sheet	Qualification	This document contains data from the preliminary specification.
Product [short] data sheet	Production	This document contains the product specification.

[1] Please consult the most recently issued document before initiating or completing a design.

[2] The term 'short data sheet' is explained in section "Definitions".

[3] The product status of device(s) described in this document may have changed since this document was published and may differ in case of multiple devices. The latest product status information is available on the Internet at URL <http://www.nxp.com>.

10.2 Definitions

Draft — The document is a draft version only. The content is still under internal review and subject to formal approval, which may result in modifications or additions. NXP Semiconductors does not give any representations or warranties as to the accuracy or completeness of information included herein and shall have no liability for the consequences of use of such information.

Short data sheet — A short data sheet is an extract from a full data sheet with the same product type number(s) and title. A short data sheet is intended for quick reference only and should not be relied upon to contain detailed and full information. For detailed and full information see the relevant full data sheet, which is available on request via the local NXP Semiconductors sales office. In case of any inconsistency or conflict with the short data sheet, the full data sheet shall prevail.

10.3 Disclaimers

General — Information in this document is believed to be accurate and reliable. However, NXP Semiconductors does not give any representations or warranties, expressed or implied, as to the accuracy or completeness of such information and shall have no liability for the consequences of use of such information.

Right to make changes — NXP Semiconductors reserves the right to make changes to information published in this document, including without limitation specifications and product descriptions, at any time and without notice. This document supersedes and replaces all information supplied prior to the publication hereof.

Suitability for use — NXP Semiconductors products are not designed, authorized or warranted to be suitable for use in medical, military, aircraft, space or life support equipment, nor in applications where failure or malfunction of a NXP Semiconductors product can reasonably be expected to

result in personal injury, death or severe property or environmental damage. NXP Semiconductors accepts no liability for inclusion and/or use of NXP Semiconductors products in such equipment or applications and therefore such inclusion and/or use is at the customer's own risk.

Applications — Applications that are described herein for any of these products are for illustrative purposes only. NXP Semiconductors makes no representation or warranty that such applications will be suitable for the specified use without further testing or modification.

Limiting values — Stress above one or more limiting values (as defined in the Absolute Maximum Ratings System of IEC 60134) may cause permanent damage to the device. Limiting values are stress ratings only and operation of the device at these or any other conditions above those given in the Characteristics sections of this document is not implied. Exposure to limiting values for extended periods may affect device reliability.

Terms and conditions of sale — NXP Semiconductors products are sold subject to the general terms and conditions of commercial sale, as published at <http://www.nxp.com/profile/terms>, including those pertaining to warranty, intellectual property rights infringement and limitation of liability, unless explicitly otherwise agreed to in writing by NXP Semiconductors. In case of any inconsistency or conflict between information in this document and such terms and conditions, the latter will prevail.

No offer to sell or license — Nothing in this document may be interpreted or construed as an offer to sell products that is open for acceptance or the grant, conveyance or implication of any license under any copyrights, patents or other industrial or intellectual property rights.

10.4 Trademarks

Notice: All referenced brands, product names, service names and trademarks are the property of their respective owners.

TrenchMOS — is a trademark of NXP B.V.

11. Contact information

For additional information, please visit: <http://www.nxp.com>

For sales office addresses, send an email to: salesaddresses@nxp.com

12. Contents

1 Product profile 1

1.1 General description 1

1.2 Features 1

1.3 Applications 1

1.4 Quick reference data 1

2 Pinning information 1

3 Ordering information 2

4 Limiting values 2

5 Thermal characteristics 4

6 Characteristics 5

7 Package outline 9

8 Soldering 10

9 Revision history 10

10 Legal information 11

10.1 Data sheet status 11

10.2 Definitions 11

10.3 Disclaimers 11

10.4 Trademarks 11

11 Contact information 11

12 Contents 12

Please be aware that important notices concerning this document and the product(s) described herein, have been included in section 'Legal information'.



© NXP B.V. 2007.

All rights reserved.

For more information, please visit: <http://www.nxp.com>

For sales office addresses, please send an email to: salesaddresses@nxp.com

Date of release: 10 October 2007

Document identifier: BUK7619-100B_1