

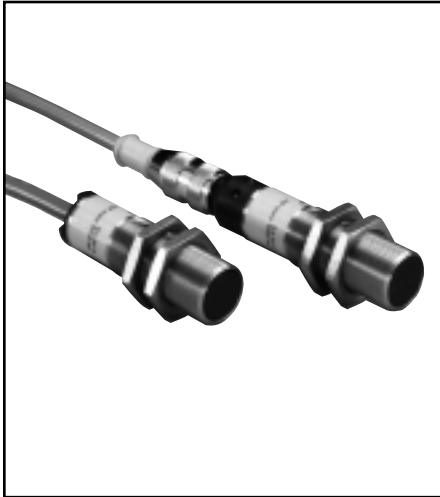

EZ-BEAM® M18 Series Sensors

Stainless Steel 18 mm Barrel-style DC Photoelectric Sensors



EZ-BEAM M18 Series Features

- 18 mm threaded-barrel sensor
- 10 to 30V dc; choose SPDT (complementary) NPN or PNP outputs (150 mA max. ea.)
- Easy to use; no adjustments are necessary
- Advanced self-diagnostics with separate alarm output†; dual LED system indicates sensor performance
- Choice of integral cable or Euro-style quick disconnect connector
- Epoxy-encapsulated circuitry; IEC IP67 (NEMA 6P) construction for harsh sensing environments
- Brackets available for a wide array of mounting options

† U.S. patent 5087838 (see Specifications, page 5)

EZ-BEAM M18 Series Sensing Mode Options

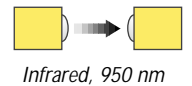
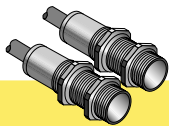

M18 Series Opposed-Mode Emitter (E) and Receiver (R)

Models	Range	Cable*	Supply Voltage	Output Type	Excess Gain	Beam Width
M186E M186EQ	20 m (66')	2 m (6.5') 4-Pin Euro-style QD	10-30V dc	—		
M18SN6R M18SN6RQ		2 m (6.5') 4-Pin Euro-style QD		NPN		
M18SP6R M18SP6RQ		2 m (6.5') 4-Pin Euro-style QD		PNP		

* 9 m (30') cables are available by adding suffix "W/30" to the model number of any cabled sensor (e.g., M18SN6R W/30). A model with a QD connector requires an optional mating cable. See page 6 for more information.

EZ-BEAM M18 Series Sensors

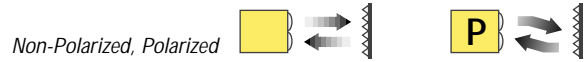
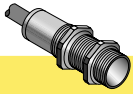

M18 Series Retroreflective Mode

Models	Range	Cable	Supply Voltage	Output Type	Excess Gain	Beam Pattern
Non-Polarized (Infrared, 950 nm)						
M18SN6L M18SN6LQ	2 m (79")	2 m (6.5') 4-Pin Euro-style QD	10-30V dc	NPN		
M18SP6L M18SP6LQ		2 m (6.5') 4-Pin Euro-style QD		PNP		
Polarized (Visible red, 680 nm)						
M18SN6LP M18SN6LPQ	2 m (79")	2 m (6.5') 4-Pin Euro-style QD	10-30V dc	NPN		
M18SP6LP M18SP6LPQ		2 m (6.5') 4-Pin Euro-style QD		PNP		

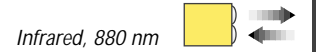
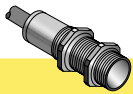

M18 Series Diffuse Mode

Models	Range	Cable	Supply Voltage	Output Type	Excess Gain	Beam Pattern
Performance based on 90% reflectance white test card						
100 mm Range						
M18SN6D M18SN6DQ	100 mm (4")	2 m (6.5') 4-Pin Euro-style QD	10-30V dc	NPN		
M18SP6D M18SP6DQ		2 m (6.5') 4-Pin Euro-style QD		PNP		
300 mm Range						
M18SN6DL M18SN6DLQ	300 mm (12")	2 m (6.5') 4-Pin Euro-style QD	10-30V dc	NPN		
M18SP6DL M18SP6DLQ		2 m (6.5') 4-Pin Euro-style QD		PNP		

EZ-BEAM M18 Series Sensors

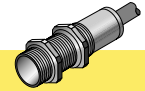

M18 Series Fixed-Field Mode

Models	Cutoff Point	Cable	Supply Voltage	Output Type	Excess Gain
					Performance based on 90% reflectance white test card
With 25 mm Far Limit Cutoff					
M18SN6FF25 M18SN6FF25Q	25 mm (1")	2 m (6.5') 4-Pin Euro-style QD	10-30V dc	NPN	
M18SP6FF25 M18SP6FF25Q		2 m (6.5') 4-Pin Euro-style QD		PNP	
With 50 mm Far Limit Cutoff					
M18SN6FF50 M18SN6FF50Q	50 mm (2")	2 m (6.5') 4-Pin Euro-style QD	10-30V dc	NPN	
M18SP6FF50 M18SP6FF50Q		2 m (6.5') 4-Pin Euro-style QD		PNP	
With 100 mm Far Limit Cutoff					
M18SN6FF100 M18SN6FF100Q	100 mm (4")	2 m (6.5') 4-Pin Euro-style QD	10-30V dc	NPN	
M18SP6FF100 M18SP6FF100Q		2 m (6.5') 4-Pin Euro-style QD		PNP	

* 9 m (30') cables are available by adding suffix **"W/30"** to the model number of any cabled sensor (e.g., **M18SN6FF25 W/30**). A model with a QD connector requires an optional mating cable. See page 6 for more information.

The excess gain curves above show excess gain vs. sensing distance for M18 Series fixed-field sensors with 25-, 50- and 100-millimeter cutoffs. Maximum excess gain for the 25-mm models occurs at a lens-to-object distance of about 7 mm; for the 50-mm models, at about 10 mm; and for the 100-mm models, at about 20 mm. Sensing at or near these distances will make maximum use of each sensor's available sensing power.

Backgrounds and background objects must *always* be placed beyond the cutoff distance.

These excess gain curves were generated using a white test card of 90% reflectance.

Objects with reflectivity of less than 90% reflect less light back to the sensor, and thus require proportionately more excess gain in order to be sensed with the same reliability as more reflective objects. When sensing an object of very low reflectivity, it may be especially important to sense it at or near the distance of maximum excess gain.

The effects of object reflectivity on cutoff distance, though small, may be important for some applications. Sensing of objects of less than 90% reflectivity causes the cutoff distances to be "pulled" slightly closer to the sensor. For example, an excess gain of 1 for an object that reflects 1/10 as much light as the 90% white card is represented by the heavy horizontal

graph line at excess gain = 10. An object of this reflectivity results in far limit cutoffs of approximately 20, 40 and 70 mm (for 25-, 50- and 100-mm cutoff models, respectively).

Objects with reflectivity greater than 90% return more light to the sensor. For this reason, highly reflective backgrounds or background objects such as mirrors, polished metal, and other sources of specular reflections require special consideration. If it is necessary to use a highly reflective background, it should be placed as far beyond the cutoff distance as possible and angled to direct reflected light away from the sensor (see page 4).

EZ-BEAM M18 Series Sensors

EZ-BEAM M18 Series Fixed-Field Sensor Setup Tips

General

For highest sensitivity, the sensor-to-object distance should be such that the object will be sensed at or near the point of maximum excess gain (see page 3). The background must be placed beyond the cutoff distance. Following these two guidelines makes it possible to detect objects of low reflectivity, even against close-in reflective backgrounds.

In the drawings and discussion on this page, the letters E, R1, and R2 identify how the sensor's three optical elements (Emitter "E", Near Detector "R1", and Far Detector "R2") line up across the face of the sensor. In Figures 2, 3, and 4, these elements align vertically; in Figure 5, they align horizontally. Note how the position of the tabs on the front of the sensor helps to define the sensing axis of the sensor (Figure 1, right). The sensing axis becomes important in situations like those illustrated in Figures 4 and 5 below.

Background reflectivity and placement

Avoid mirror-like backgrounds that produce specular reflections. False sensor response will occur if a background surface reflects the sensor's light more strongly to the near detector (R1) than to the far detector (R2). The result is a false ON condition (Figure 2). Use of a diffusely-reflective (matte) background will cure this problem. Other possible solutions are to either angle the sensor or angle the background (in any plane) so that the background does not reflect back to the sensor (see Figure 3).

An object beyond the cutoff distance, either moving or stationary (and when positioned as shown in Figure 4), can cause unwanted triggering of the sensor because it reflects more light to the near detector than to the far detector. Remedy the problem easily by rotating the sensor 90° (Figure 5) to align the sensing axis horizontally. The object then reflects the R1 and R2 fields equally, resulting in no false triggering. A better solution, if possible, may be to reposition the object or the sensor.

Unwanted triggering of the sensor from an object beyond the cutoff can also be caused by attempting to sense a small object moving perpendicular to the sensor face, or by an object moving through the off-center position shown in Figure 4. Making the object larger, centering the sensor relative to the object, or rotating the sensor to place the sensing axis perpendicular to the longer dimension of the object (Figure 5) will solve the problem.

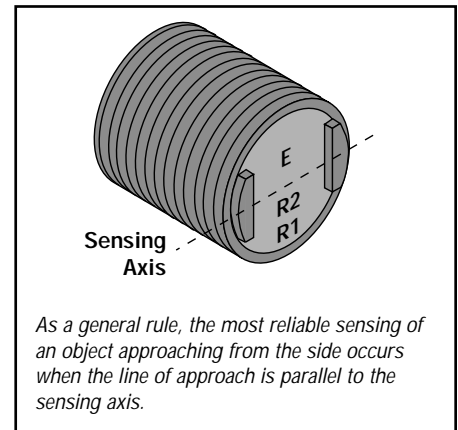

Figure 1. Sensing axis

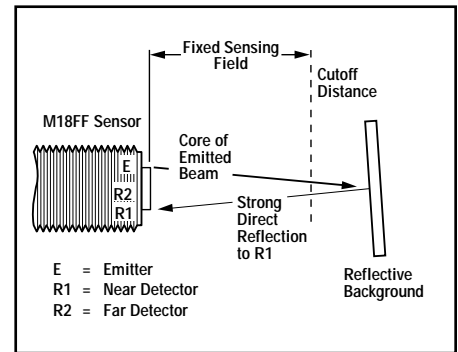

Figure 2. Reflective background – problem

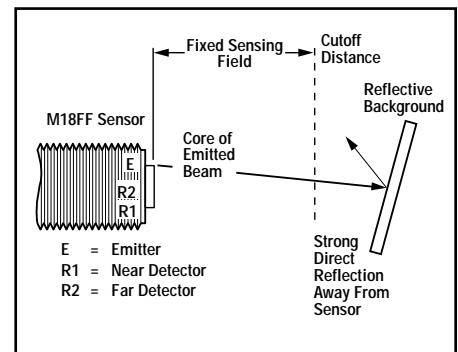

Figure 3. Reflective background – solution

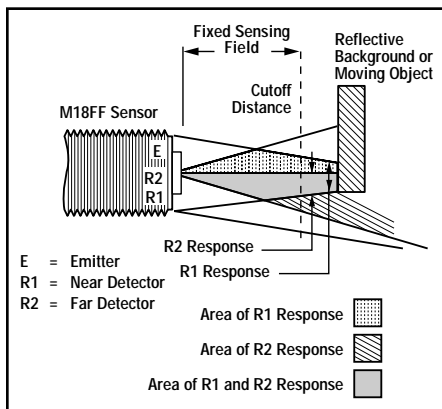

Figure 4. Object beyond cutoff – problem

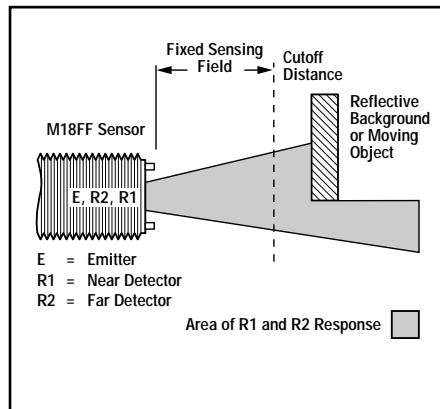

Figure 5. Object beyond cutoff – solution

EZ-BEAM M18 Series Sensors

EZ-BEAM M18 Series Specifications

Supply Voltage and Current Opposed Mode Emitters: Opposed Mode Receivers: Polarized Retro: Non-polarized Retro: Fixed-field: Diffuse:	10 to 30V dc (10% maximum ripple); Supply current (exclusive of load current): 25 mA 20 mA 30 mA 25 mA 35 mA 25 mA
Supply Protection Circuitry	Protected against reverse polarity and transient voltages
Output Configuration	SPDT (complementary) solid-state dc switch; choose NPN (current sinking) or PNP (current sourcing) models. Light operate: N.O. output conducts when the sensor sees its own (or the emitter's) modulated light Dark operate: N.C. output conducts when the sensor sees dark; the N.C. (normally closed) output may be wired as a normally open alarm output, depending upon hookup to the power supply (U.S. patent 5087838)
Output Rating	150 mA maximum (each) in standard hookup; When wired for alarm output, the total load may not exceed 150 mA; Off-state leakage current < 1 microamp at 30V dc; On-state saturation voltage < 1V at 10 mA dc; < 1.5V at 150 mA dc
Output Protection Circuitry	Protected against false pulse on power-up and continuous overload or short circuit of outputs
Output Response Time	Opposed: 3 milliseconds ON, 1.5 milliseconds OFF; Polarized Retro, Non-Polarized Retro, Fixed-field and Diffuse: 3 milliseconds ON and OFF NOTE: 100 millisecond delay on power-up; outputs do not conduct during this time
Repeatability	Opposed mode: 375 microseconds; Polarized Retro, Non-Polarized Retro, Fixed-field and Diffuse modes: 750 microseconds; Repeatability and response are independent of signal strength
Indicators	Two LEDs: Green and Yellow Green glowing steadily power to sensor is ON Green flashing output is overloaded Yellow glowing steadily normally open output is conducting Yellow flashing excess gain marginal (1-1.5x) in light condition
Construction	Housings are Stainless Steel; Lenses are Lexan® (opposed models) or acrylic
Environmental Rating	Rated NEMA 6P (IEC IP67)
Connections	2 m (6.5') or 9 m (30') attached cable, or 4-pin Euro-style quick disconnect fitting
Operating Conditions	Temperature: -40° to +70°C (-40° to 158°F) Maximum relative humidity: 90% at 50°C (non-condensing)
Vibration and Mechanical Shock	All models meet Mil. Std. 202F requirements. Method 201A (Vibration; frequency 10 to 60 Hz, max., double amplitude 0.06" acceleration 10G). Method 213B conditions H&I (Shock: 75G with unit operating; 100G for non-operation)

EZ-BEAM M18 Series Sensors

EZ-BEAM M18 Series Dimensions

Models with Attached Cable

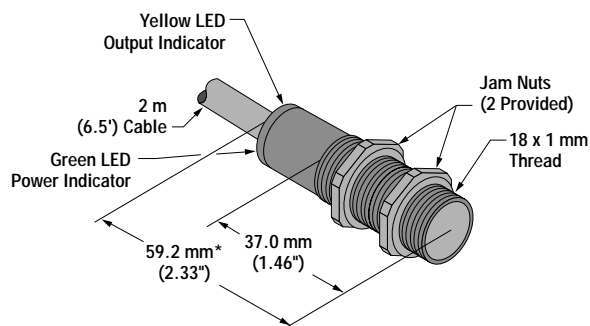

Models with Quick-Disconnect

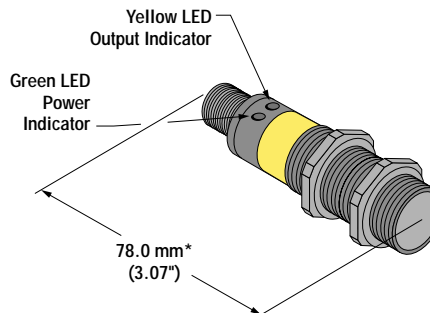

* Polarized retroreflective and fixed-field cabled models = 65.0 mm (2.56")

* Polarized retroreflective and fixed-field QD models = 83.8 mm (3.30")

EZ-BEAM M18 Series Hookups

Sensors with NPN (Sinking) Outputs Standard Hookup

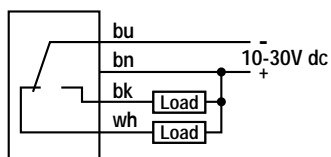

Sensors with PNP (Sourcing) Outputs Standard Hookup

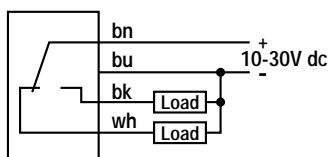

Emitters with Attached Cable

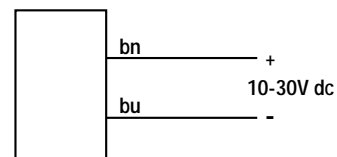

Alarm Hookup

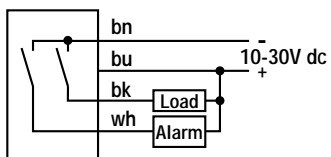

Alarm Hookup

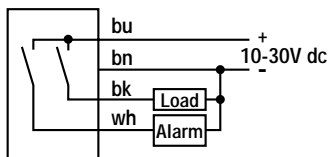

DC Emitters with Quick Disconnect (No connection to bk and wh wires of QD cable.)

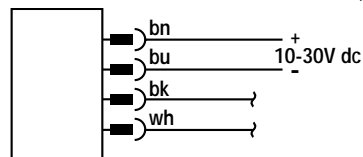

NOTE: hookups are the same for either an integral or QD cable.

Quick-disconnect (QD) Cables

Style	Model	Length	Connector	Pin Out
4-Pin Euro-style	MQDC-406	2 m (6.5')	Straight Straight Straight Right-Angle Right-Angle Right-Angle	
	MQDC-415	5 m (15')		
	MQDC-430	9 m (30')		
	MQDC-406RA	2 m (6.5')		
	MQDC-415RA	5 m (15')		
	MQDC-430RA	9 m (30')		

EZ-BEAM M18 Series Sensors

Mounting Brackets

<p>SMB18A</p>	<ul style="list-style-type: none"> • 11-gauge stainless steel • Right-angle bracket with a curved mounting slot for versatility and orientation 	<p>SMB18C</p>	<ul style="list-style-type: none"> • 18 mm split clamp, black thermoplastic polyester • Stainless steel mounting hardware included
<p>SMB18SF</p>	<ul style="list-style-type: none"> • 18 mm swivel bracket • Black thermoplastic polyester 	<p>SMB18UR</p>	<ul style="list-style-type: none"> • 2-piece universal swivel bracket for 18 mm sensors • 300 series stainless steel
<p>SMB30SK</p>	<ul style="list-style-type: none"> • Flat-mount swivel bracket with extended range of motion • Black reinforced thermoplastic polyester and 316 stainless steel 		

EZ-BEAM M18 Series Sensors

Aperture Kits for M18 Series Opposed-Mode Sensors

Aperture kits are available for M18 Series opposed-mode sensors. Apertures are used to narrow and/or shape the sensor's effective beam for use in specialized applications.

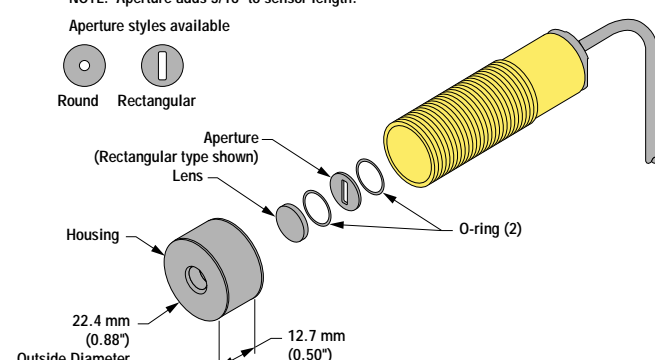
Model	Description	
AP18SC	Kit includes round apertures of: 0.5 mm (0.02"), 1.0 mm (0.04") & 2.5 mm (0.10") in diameter	<p>NOTE: Aperture adds 3/16" to sensor length.</p> <p>Aperture styles available</p>  <p>Round Rectangular</p> <p>Aperture (Rectangular type shown)</p> <p>Lens</p> <p>Housing</p> <p>O-ring (2)</p> <p>22.4 mm (0.88") Outside Diameter</p> <p>12.7 mm (0.50")</p>
AP18SR	Kit includes rectangular apertures of: 0.5 mm (0.02"), 1.0 mm (0.04") & 2.5 mm (0.10") wide Each kit also includes a thread-on aperture housing, a Teflon FEP [®] lens and two O-rings	



WARNING . . . Not To Be Used for Personnel Protection

Never use these products as sensing devices for personnel protection. Doing so could lead to serious injury or death.

These sensors do NOT include the self-checking redundant circuitry necessary to allow their use in personnel safety applications. A sensor failure or malfunction can cause either an energized or de-energized sensor output condition. Consult your current Banner Safety Products catalog for safety products which meet OSHA, ANSI and IEC standards for personnel protection.

WARRANTY: Banner Engineering Corp. warrants its products to be free from defects for one year. Banner Engineering Corp. will repair or replace, free of charge, any product of its manufacture found to be defective at the time it is returned to the factory during the warranty period. This warranty does not cover damage or liability for the improper application of Banner products. This warranty is in lieu of any other warranty either expressed or implied.