

IR-Lumineszenzdiode (850 nm) mit hoher Ausgangsleistung
High Power Infrared Emitter (850 nm)
Lead (Pb) Free Product - RoHS Compliant
SFH 4850 E7800



Vorläufige Daten / Preliminary Data

Wesentliche Merkmale

- Infrarot LED mit hoher Ausgangsleistung
- Anode galvanisch mit dem Gehäuseboden verbunden
- Emissionswellenlänge typ. 850 nm
- Sehr hohe Strahldichte
- Anwendungsklasse nach DIN 40 040 GQG

Anwendungen

- Sensorik
- Lichtgitter

Sicherheitshinweise

Je nach Betriebsart emittieren diese Bauteile hochkonzentrierte, nicht sichtbare Infrarot-Strahlung, die gefährlich für das menschliche Auge sein kann. Produkte, die diese Bauteile enthalten, müssen gemäß den Sicherheitsrichtlinien der IEC-Normen 60825-1 und 62471 behandelt werden.

Features

- High Power Infrared LED
- Anode is electrically connected to the case
- Peak wavelength typ. 850 nm
- Very high radiance
- DIN humidity category in acc. with DIN 40 040 GQG

Applications

- Sensor technology
- Light curtains

Safety Advices

Depending on the mode of operation, these devices emit highly concentrated non visible infrared light which can be hazardous to the human eye. Products which incorporate these devices have to follow the safety precautions given in IEC 60825-1 and IEC 62471.

Typ Type	Bestellnummer Ordering Code	Strahlstärkegruppierung ¹⁾ ($I_F = 100 \text{ mA}$, $t_p = 20 \text{ ms}$) Radiant Intensity Grouping ¹⁾ I_e (mW/sr)
SFH 4850 E7800	Q65110A2093	≥ 4 (typ. 7)

¹⁾ gemessen bei einem Raumwinkel $\Omega = 0.01 \text{ sr}$ / measured at a solid angle of $\Omega = 0.01 \text{ sr}$



ATTENTION - Observe Precautions For Handling - Electrostatic Sensitive Device

Grenzwerte ($T_C = 25\text{ °C}$)**Maximum Ratings**

Bezeichnung Parameter	Symbol Symbol	Wert Value	Einheit Unit
Betriebs- und Lagertemperatur Operating and storage temperature range	T_{op}, T_{stg}	- 40 ... + 80	°C
Sperrspannung Reverse voltage	V_R	5	V
Vorwärtsgleichstrom Forward current	I_F	200	mA
Stoßstrom, $t_p = 10\ \mu\text{s}$, $D = 0$ Surge current	I_{FSM}	1	A
Verlustleistung Power dissipation	P_{tot}	470	mW
Wärmewiderstand Sperrschicht - Umgebung Thermal resistance junction - ambient	R_{thJA}	450	K/W
Wärmewiderstand Sperrschicht - Gehäuse Thermal resistance junction - case	R_{thJC}	160	K/W

Kennwerte ($T_A = 25\text{ °C}$)**Characteristics**

Bezeichnung Parameter	Symbol Symbol	Wert Value	Einheit Unit
Wellenlänge der Strahlung Wavelength at peak emission $I_F = 100\text{ mA}$	λ_{peak}	850	nm
Spektrale Bandbreite bei 50% von I_{max} Spectral bandwidth at 50% of I_{max} $I_F = 100\text{ mA}$	$\Delta\lambda$	35	nm
Abstrahlwinkel Half angle	φ	± 23	Grad deg.
Aktive Chipfläche Active chip area	A	0.09	mm ²
Abmessungen der aktiven Chipfläche Dimension of the active chip area	$L \times B$ $L \times W$	0.3×0.3	mm ²
Schaltzeiten, I_e von 10% auf 90% und von 90% auf 10%, bei $I_F = 100\text{ mA}$, $R_L = 50\ \Omega$ Switching times, I_e from 10% to 90% and from 90% to 10%, $I_F = 100\text{ mA}$, $R_L = 50\ \Omega$	t_r, t_f	12	ns

Kennwerte ($T_A = 25\text{ °C}$)
Characteristics (cont'd)

Bezeichnung Parameter	Symbol Symbol	Wert Value	Einheit Unit
Durchlassspannung Forward voltage $I_F = 100\text{ mA}$, $t_p = 20\text{ ms}$ $I_F = 1\text{ A}$, $t_p = 100\text{ }\mu\text{s}$	V_F V_F	1.5 (< 1.8) 2.4 (< 3.0)	V V
Sperrstrom Reverse current $V_R = 5\text{ V}$	I_R	not designed for reverse operation	μA
Gesamtstrahlungsfluss Total radiant flux $I_F = 100\text{ mA}$, $t_p = 20\text{ ms}$	$\Phi_{e\text{ typ}}$	50	mW
Temperaturkoeffizient von I_e bzw. Φ_e , $I_F = 100\text{ mA}$ Temperature coefficient of I_e or Φ_e , $I_F = 100\text{ mA}$	TC_I	- 0.5	%/K
Temperaturkoeffizient von V_F , $I_F = 100\text{ mA}$ Temperature coefficient of V_F , $I_F = 100\text{ mA}$	TC_V	- 0.7	mV/K
Temperaturkoeffizient von λ , $I_F = 100\text{ mA}$ Temperature coefficient of λ , $I_F = 100\text{ mA}$	TC_λ	+ 0.2	nm/K

Strahlstärke I_e in Achsrichtung¹⁾gemessen bei einem Raumwinkel $\Omega = 0.01$ sr**Radiant Intensity I_e in Axial Direction**at a solid angle of $\Omega = 0.01$ sr

Bezeichnung Parameter	Symbol	Werte Values		Einheit Unit
		SFH 4850 E7800 -P	SFH 4850 E7800 -Q	
Strahlstärke Radiant intensity $I_F = 100$ mA, $t_p = 20$ ms	$I_{e \text{ min}}$ $I_{e \text{ max}}$	4 8	6.3 12.5	mW/sr mW/sr
Strahlstärke Radiant intensity $I_F = 1$ A, $t_p = 100$ μ s	$I_{e \text{ typ}}$	45	55	mW/sr

¹⁾ Nur eine Gruppe in einer Verpackungseinheit (Streuung kleiner 2:1)

Die Messung der Strahlstärke und des Halbwinkels erfolgt mit einer Lochblende vor dem Bauteil (Durchmesser der Lochblende: 1.1 mm; Abstand Lochblende zu Gehäuserückseite: 4,0 mm). Dadurch wird sichergestellt, dass bei der Strahlstärkemessung nur diejenige Strahlung in Achsrichtung bewertet wird, die direkt von der Chipoberfläche austritt. Von der Bodenplatte reflektierte Strahlung (vagabundierende Strahlung) wird dagegen nicht bewertet. Diese Reflexionen sind besonders bei Abbildungen der Chipoberfläche über Zusatzoptiken störend (z.B. Lichtschranken großer Reichweite). In der Anwendung werden im allgemeinen diese Reflexionen ebenfalls durch Blenden unterdrückt. Durch dieses der Anwendung entsprechende Messverfahren ergibt sich für die Anwender eine besser verwertbare Größe. Diese Lochblendenmessung ist gekennzeichnet durch den Eintrag „E 7800“, der an die Typenbezeichnung angehängt ist.

¹⁾ Only one group in one packing unit, (variation lower 2:1)

An aperture is used in front of the component for measurement of the radiant intensity and the half angle (diameter of the aperture: 1.1 mm; distance of aperture to case back side: 4.0 mm). This ensures that solely the radiation in axial direction emitting directly from the chip surface will be evaluated during measurement of the radiant intensity. Radiation reflected by the bottom plate (stray radiation) will not be evaluated. These reflections impair the projection of the chip surface by additional optics (e.g. long-range light reflection switches). In respect of the application of the component, these reflections are generally suppressed by apertures as well. This measuring procedure corresponding with the application provides more useful values. This aperture measurement is denoted by 'E 7800' added to the type designation.

Relative Spectral Emission

$I_{rel} = f(\lambda)$

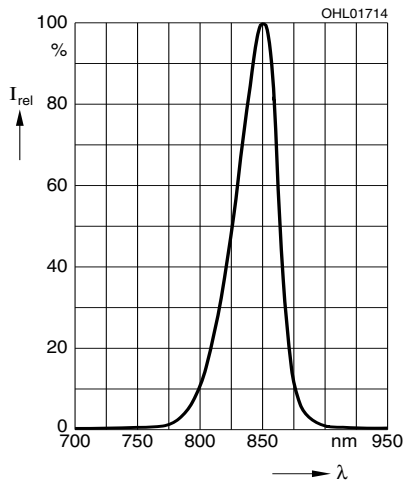

Forward Current $I_F = f(V_F)$

Single pulse, $t_p = 20 \mu s$

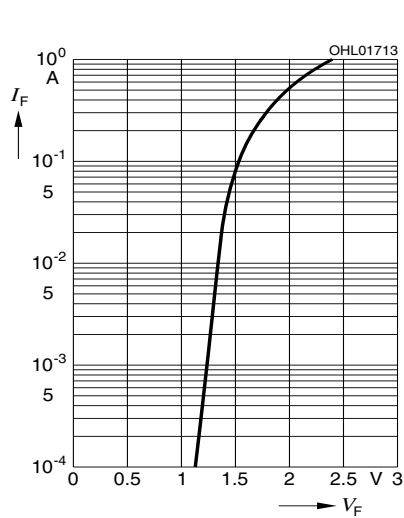

Radiant Intensity $\frac{I_e}{I_e 100 \text{ mA}} = f(I_F)$

Single pulse, $t_p = 20 \mu s$

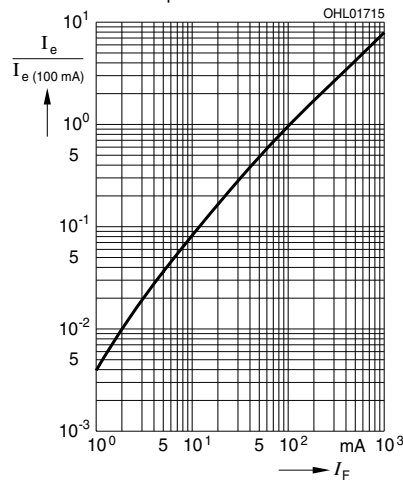

Max. Permissible Forward Current $I_F = f(T_A)$

$I_F = f(T_A)$

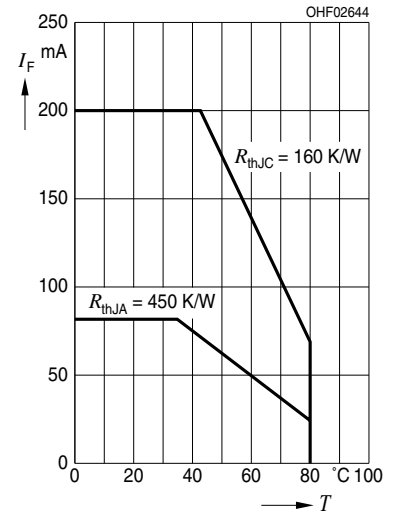

Permissible Pulse Handling Capability $I_F = f(\tau)$, $T_C = 25 \text{ }^\circ\text{C}$, duty cycle $D =$ parameter

$T_C = 25 \text{ }^\circ\text{C}$, duty cycle $D =$ parameter

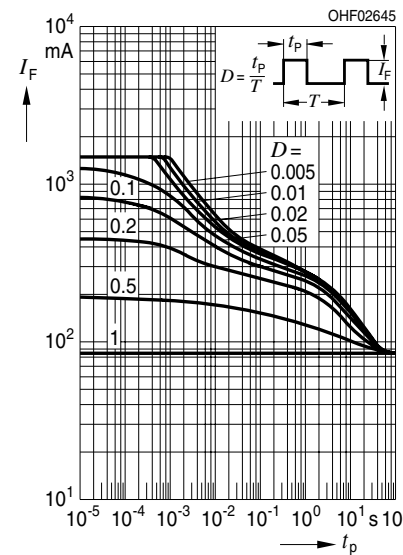

**Maßzeichnung
Package Outlines**

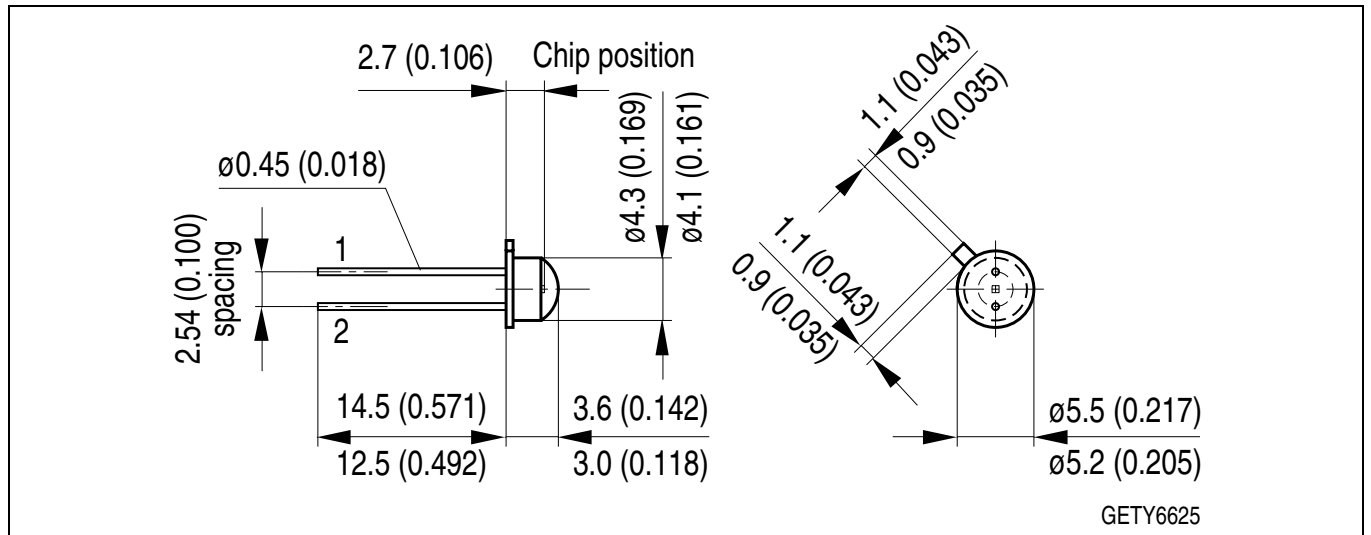

Maße in mm (inch) / Dimensions in mm (inch).

Gehäuse / Package	18 A3 DIN 41870 (TO-18), Bodenplatte, klares Epoxy-Gießharz, Anschlüsse im 2.54-mm-Raster (1/10") 18 A3 DIN 41870 (TO-18), clear epoxy resin, lead spacing 2.54-mm(1/10")
Anschlussbelegung Pin configuration	1 = Kathode / cathode 2 = Anode / anode

Abstrahlcharakteristik

Radiation Characteristics $I_{rel} = f(\varphi)$

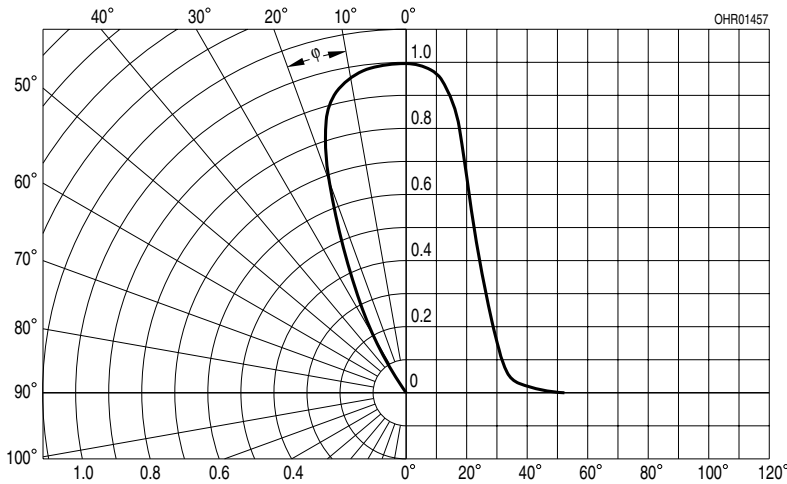

Lötbedingungen
Soldering Conditions
Wellenlöten (TTW)
TTW Soldering

(nach CECC 00802)
(acc. to CECC 00802)

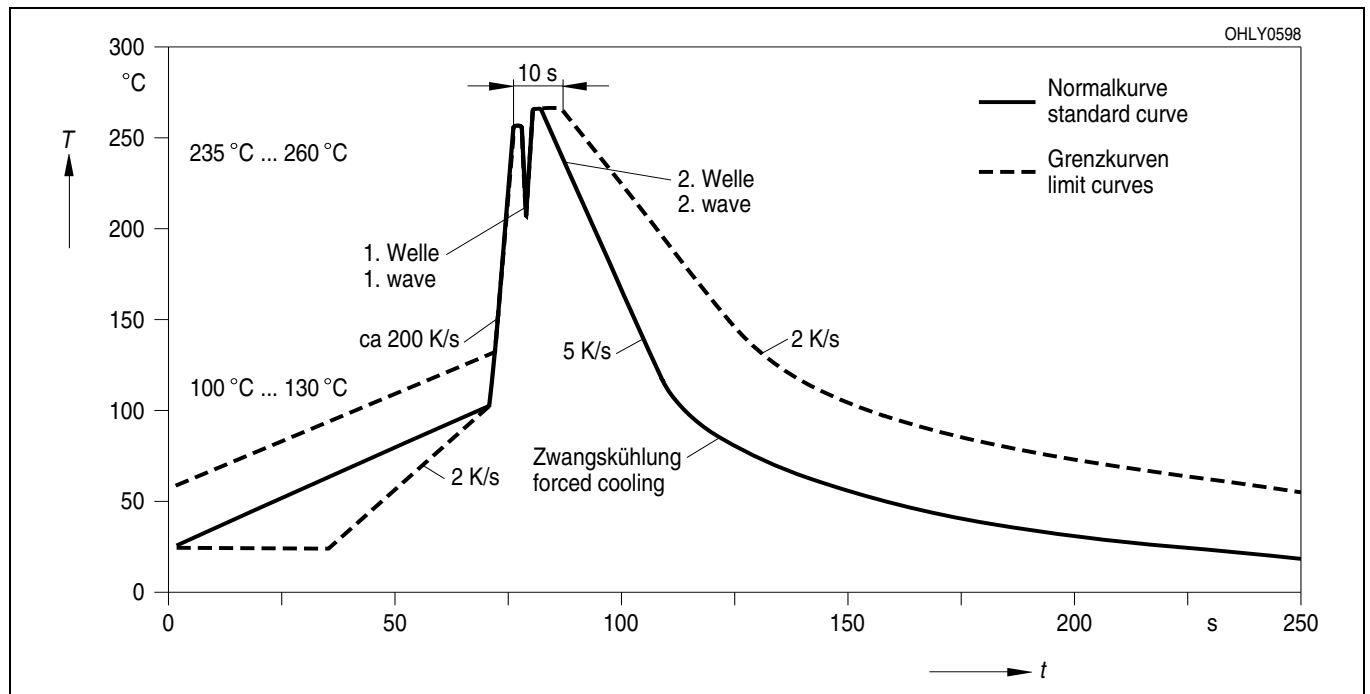

Published by
OSRAM Opto Semiconductors GmbH
Wernerwerkstrasse 2, D-93049 Regensburg
www.osram-os.com
© All Rights Reserved.

EU RoHS and China RoHS compliant product



此产品符合欧盟 RoHS 指令的要求；

按照中国的相关法规和标准，不含有毒有害物质或元素。

The information describes the type of component and shall not be considered as assured characteristics. Terms of delivery and rights to change design reserved. Due to technical requirements components may contain dangerous substances. For information on the types in question please contact our Sales Organization.

Packing

Please use the recycling operators known to you. We can also help you – get in touch with your nearest sales office. By agreement we will take packing material back, if it is sorted. You must bear the costs of transport. For packing material that is returned to us unsorted or which we are not obliged to accept, we shall have to invoice you for any costs incurred.

Components used in life-support devices or systems must be expressly authorized for such purpose! Critical components¹, may only be used in life-support devices or systems² with the express written approval of OSRAM OS.

¹ A critical component is a component used in a life-support device or system whose failure can reasonably be expected to cause the failure of that life-support device or system, or to affect its safety or effectiveness of that device or system.

² Life support devices or systems are intended (a) to be implanted in the human body, or (b) to support and/or maintain and sustain human life. If they fail, it is reasonable to assume that the health of the user may be endangered.