

### IGBT MODULE (U series) 600V / 100A



#### ■ Features

- Low  $V_{CE(sat)}$
- Compact Package
- P.C. Board Mount Module

#### ■ Applications

- Inverter for Motoe Drive
- AC and DC Servo Drive Amplifier
- Uninterruptible Power Supply

#### ■ Maximum ratings and characteristics

● Absolute maximum ratings ( $T_c=25^{\circ}\text{C}$  unless otherwise specified)

Item	Symbol	Condition	Rating	Unit
Collector-Emitter voltage	$V_{CES}$		600	V
Gate-Emitter voltage	$V_{GES}$		$\pm 20$	V
Collector current	$I_c$	Continuous	100	A
	$I_{cP}$	1ms	200	
	$-I_c$		100	
	$-I_c$ pulse		200	
Collector power dissipation	$P_c$	1 device	380	W
Operating junction temperature	$T_j$		+150	$^{\circ}\text{C}$
Storage temperature	$T_{stg}$		-40 to +125	$^{\circ}\text{C}$
Isolation voltage	$V_{iso}$	AC : 1 minute	AC 2500	V
			AC 2500	V
Mounting screw torque			3.5 *1	N·m

\*1 Recommendable value : 2.5 to 3.5 N·m (M5)

\*2 All terminals should be connected together when isolation test will be done.

\*3 Two thermistor terminals should be connected together, each other terminals should be connected together and shorted to base plate when isolation test will be done.

### ● Electrical characteristics (Tj=25°C unless otherwise specified)

Item	Symbol	Condition	Characteristics			Unit	
			Min.	Typ.	Max.		
Inverter	Zero gate voltage collector current	ICES	VCE=600V, VGE=0V			mA	
	Gate-Emitter leakage current	IGES	VCE=0V, VGE=±20V			nA	
	Gate-Emitter threshold voltage	VGE(th)	VCE=20V, Ic=100mA			V	
	Collector-Emitter saturation voltage	VCE(sat) (terminal)	VGE=15V Ic=100A	Tj=25°C	2.20	2.50	V
				Tj=125°C	2.35	-	
		VCE(sat) (chip)	Tj=25°C	1.85	-		
			Tj=125°C	2.00	-		
	Input capacitance	Cies	VGE=0V, VCE=10V, f=1MHz			nF	
	Turn-on time	ton	VCC=300V			µs	
		tr	Ic=100A				
		tr(i)	VGE=±15V				
	Turn-off time	toff	RG= 33 Ω			µs	
		tf					
	Forward on voltage	VF (terminal)	VGE= 0 V IF=100A	Tj=25°C	1.95	2.30	V
				Tj=125°C	2.00	-	
VF (chip)		Tj=25°C	1.60	-			
		Tj=125°C	1.65	-			
Reverse recovery time	trr	IF=100A			µs		
Lead resistance, terminal-chip *	R lead				mΩ		
Thermistor	Resistance	T=25°C	-	5000	-	Ω	
		T=100°C	465	495	520		
	B value	B	T=25/50°C	3305	3375	3450	K

\* Biggest internal terminal resistance among arm.

### ● Thermal resistance Characteristics

Item	Symbol	Condition	Characteristics			Unit
			Min.	Typ.	Max.	
Thermal resistance ( 1 device )	Rth(j-c)	IGBT	-	-	0.33	°C/W
		FWD	-	-	0.66	
Contact thermal resistance *	Rth(c-f)	With thermal compound			-	

\* This is the value which is defined mounting on the additional cooling fin with thermal compound

### ■ Equivalent Circuit Schematic

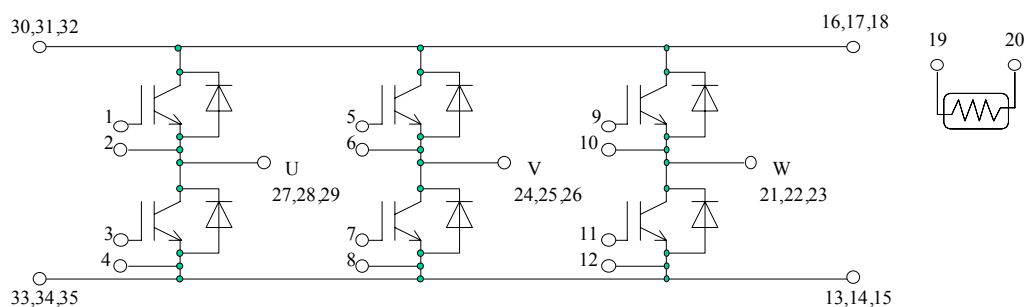

■ Characteristics (Representative)

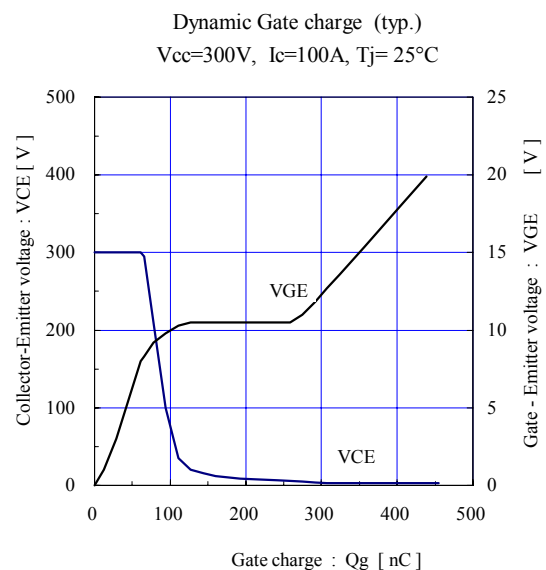
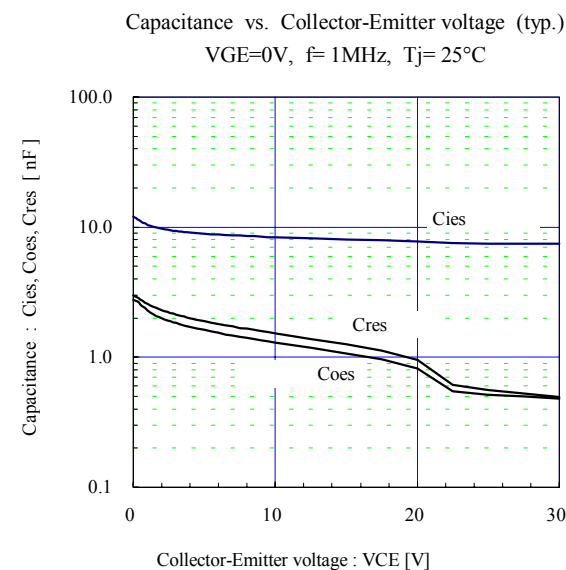
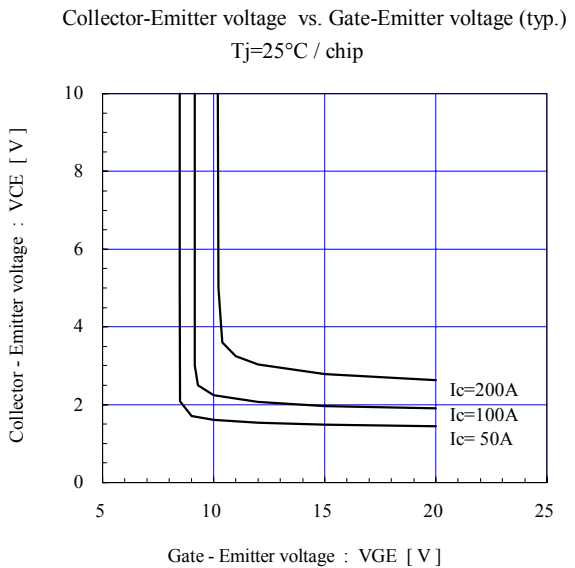
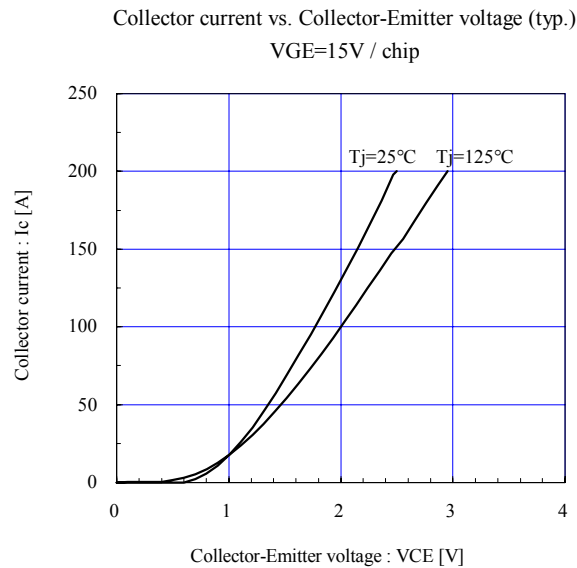
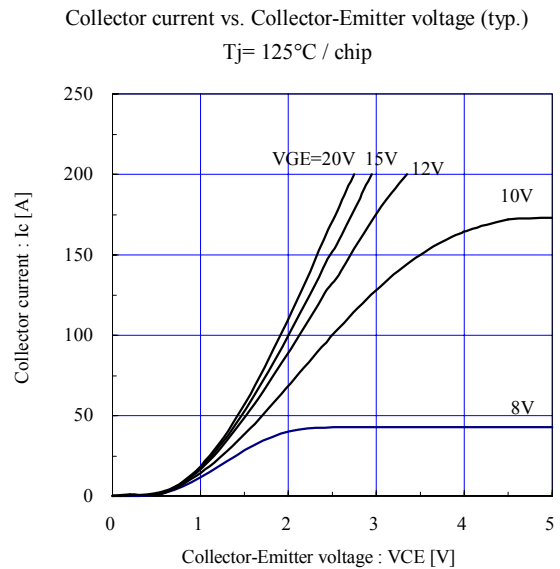
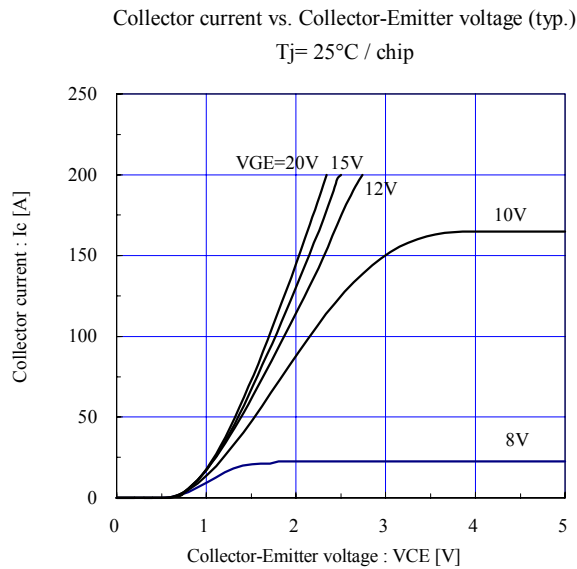

Switching time vs. Collector current (typ.)  
 $V_{cc}=300V, V_{GE}=\pm 15V, R_g=33\Omega, T_j=25^\circ C$

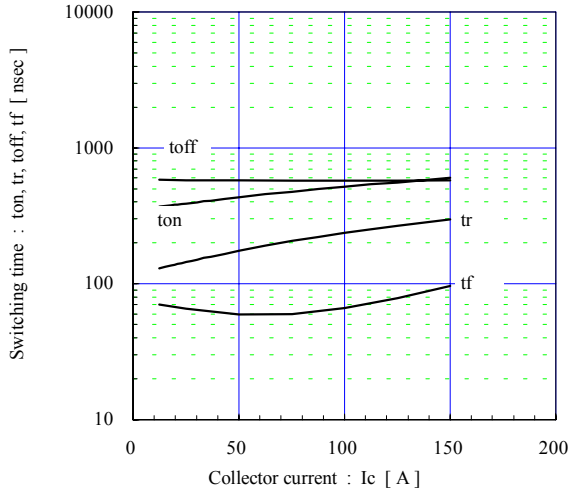

Switching time vs. Collector current (typ.)  
 $V_{cc}=300V, V_{GE}=\pm 15V, R_g=33\Omega, T_j=125^\circ C$

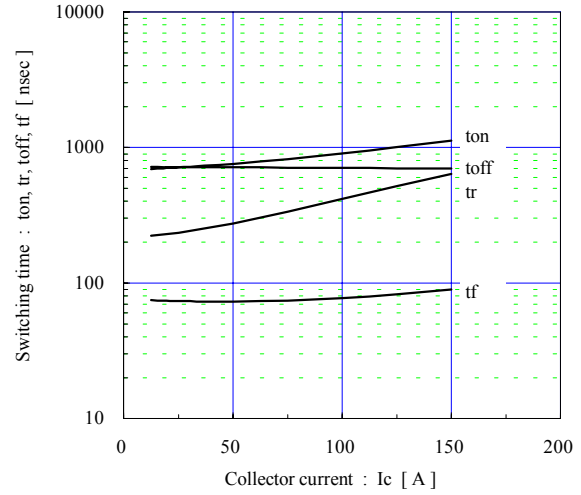

Switching time vs. Gate resistance (typ.)  
 $V_{cc}=300V, I_c=100A, V_{GE}=\pm 15V, T_j=25^\circ C$

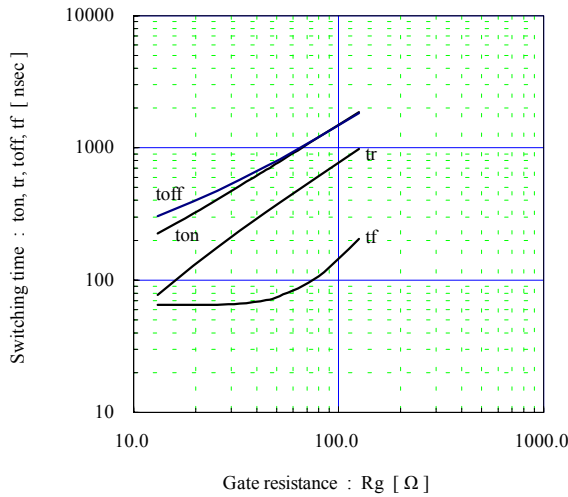

Switching loss vs. Collector current (typ.)  
 $V_{cc}=300V, V_{GE}=\pm 15V, R_g=33\Omega$

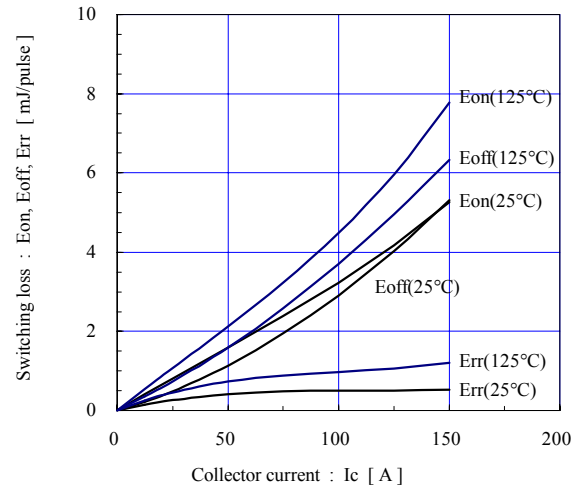

Switching loss vs. Gate resistance (typ.)  
 $V_{cc}=300V, I_c=100A, V_{GE}=\pm 15V, T_j=125^\circ C$

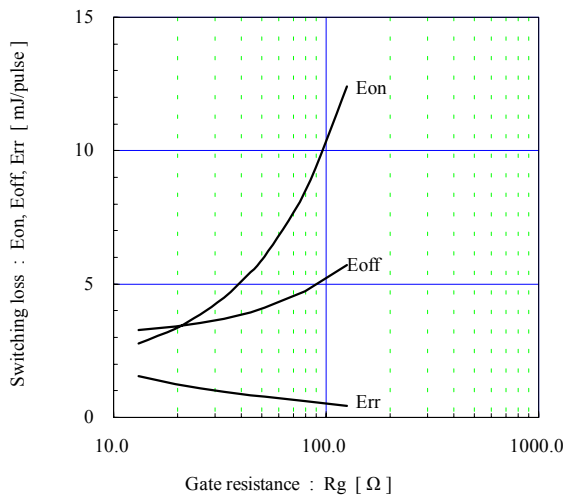

Reverse bias safe operating area (max.)  
 $+V_{GE}=15V, -V_{GE} \le 15V, R_g \ge 33\Omega, T_j \le 125^\circ C$

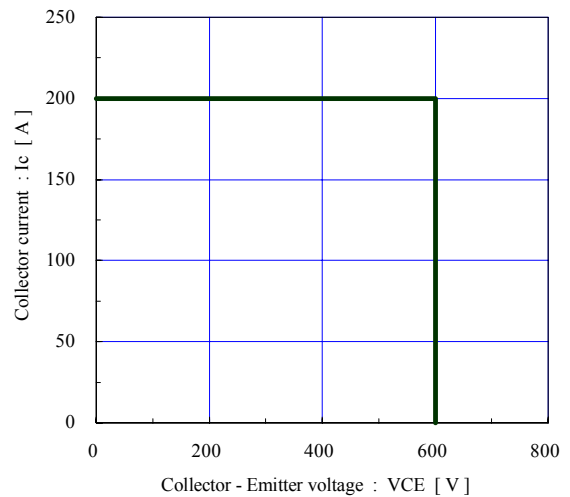

Forward current vs. Forward on voltage (typ.)  
chip

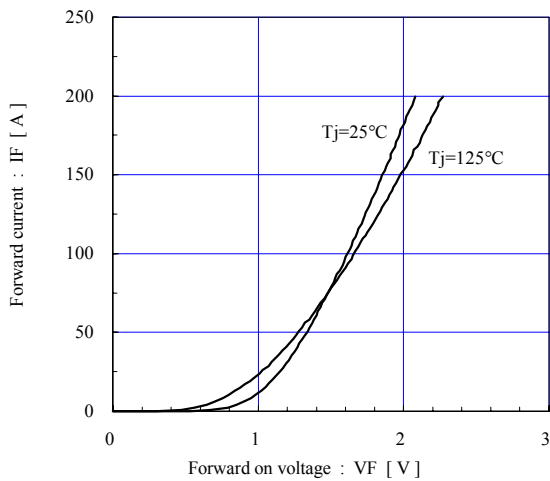

Reverse recovery characteristics (typ.)  
 $V_{cc}=300\text{V}$ ,  $V_{GE}=\pm 15\text{V}$ ,  $R_g=33\Omega$

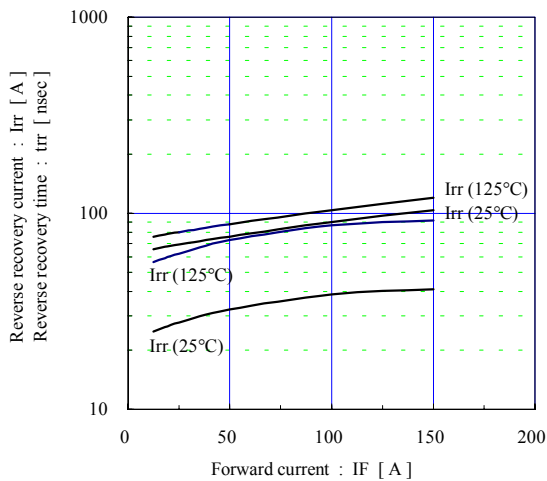

Transient thermal resistance (max.)

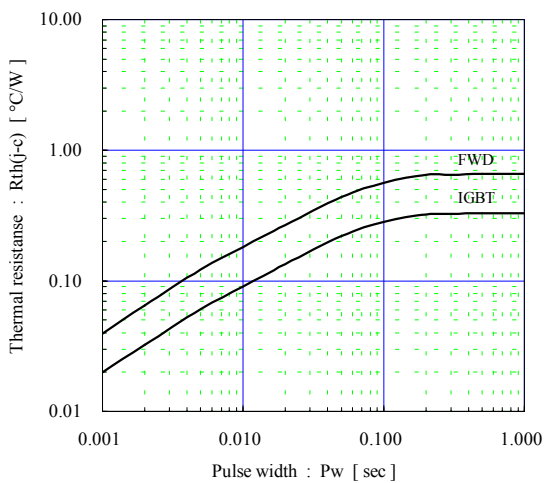

Temperature characteristic (typ.)

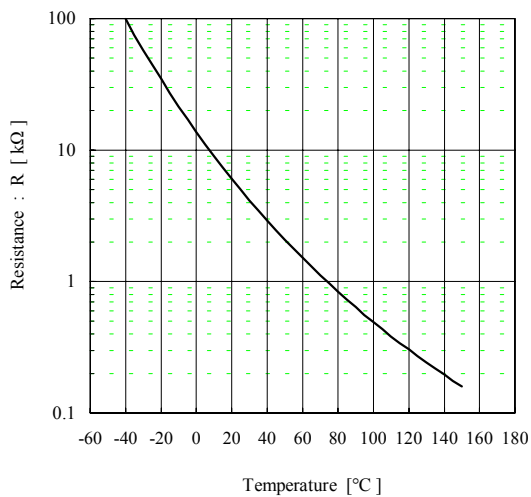

■ Outline Drawings, mm

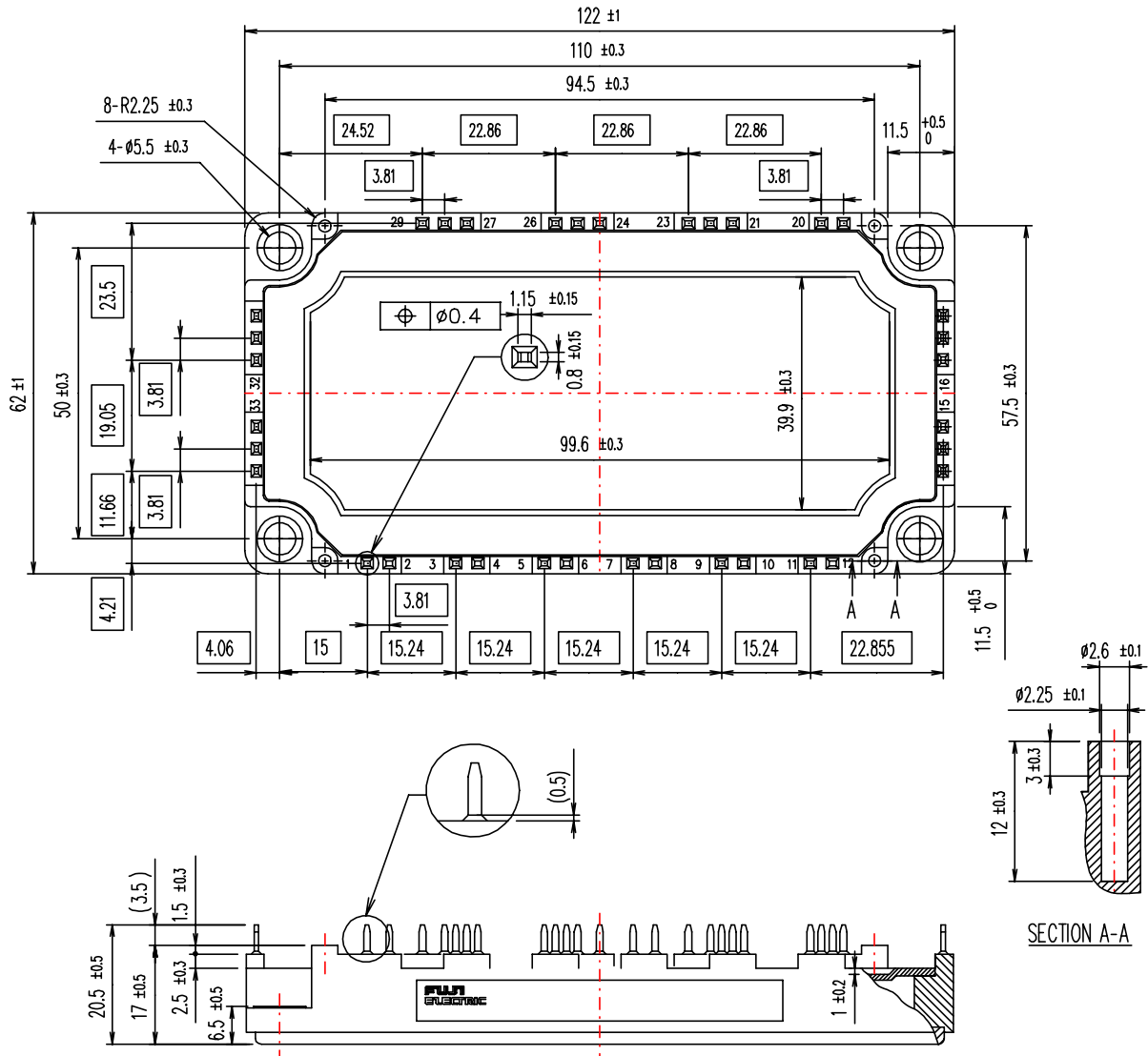

□ shows theoretical dimension.

( ) shows reference dimension.