

TOSHIBA CMOS Digital Integrated Circuit Silicon Monolithic

# TC74LCX16374FT

## Low-Voltage 16-Bit D-Type Flip-Flop with 5-V Tolerant Inputs and Outputs

The TC74LCX16374FT is a high-performance CMOS 16-bit D-type flip-flop. Designed for use in 2.5-V or 3.3-V systems, it achieves high-speed operation while maintaining the CMOS low power dissipation.

The device is designed for low-voltage (2.5-V or 3.3-V) VCC applications, but it could be used to interface to 5-V supply environment for both inputs and outputs.

This 16-bit D-type flip-flop is controlled by a clock input (CK) and an output enable input ( $\overline{OE}$ ) which are common to each byte. It can be used as two 8-bit flip-flops or one 16-bit flip-flop. When the  $\overline{OE}$  input is high, the outputs are in a high-impedance state.

All inputs are equipped with protection circuits against static discharge.

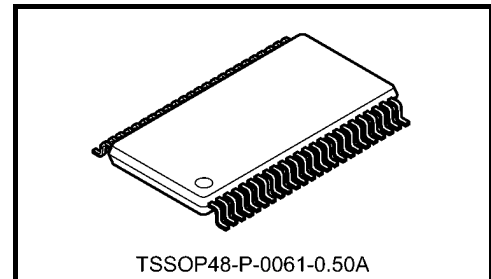

Weight: 0.25 g (typ.)

### Features

- Low-voltage operation:  $V_{CC} = 2.0$  to  $3.6$  V
- High-speed operation:  $t_{pd} = 6.2$  ns (max) ( $V_{CC} = 3.0$  to  $3.6$  V)
- Output current:  $|I_{OH}|/I_{OL} = 24$  mA (min) ( $V_{CC} = 3.0$  V)
- Latch-up performance:  $-500$  mA
- Package: TSSOP
- Power-down protection provided on all inputs and outputs

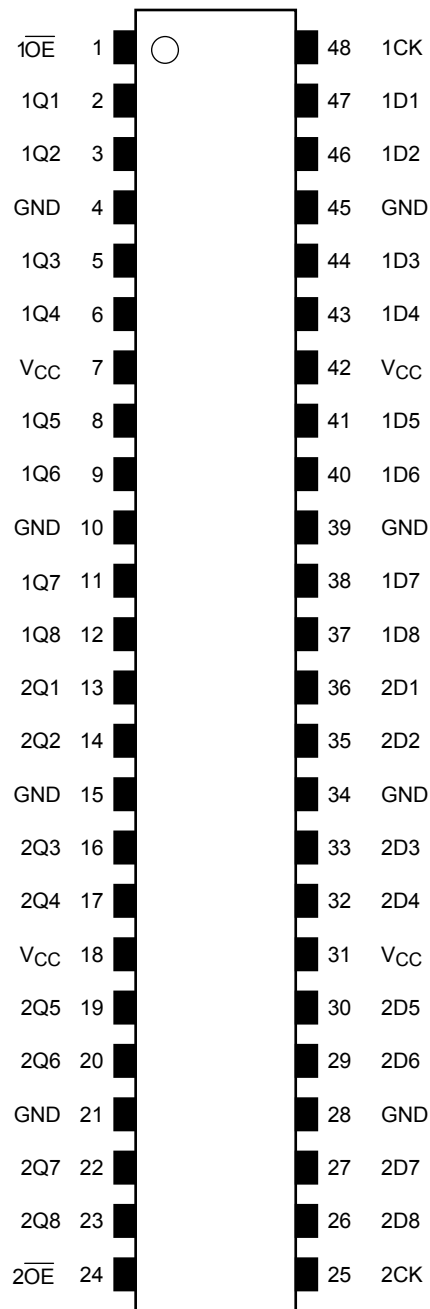

## Pin Assignment (top view)



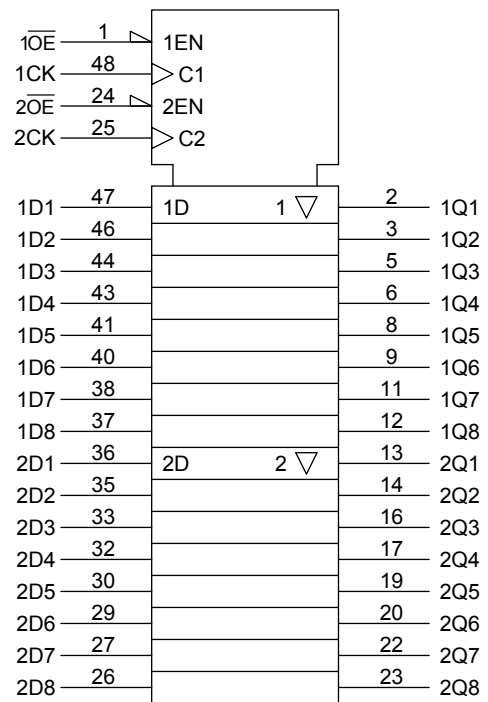

## IEC Logic Symbol



## Truth Table

Inputs			Outputs
$\overline{1OE}$	1CK	1D1-1D8	1Q1-1Q8
H	X	X	Z
L		X	Qn
L		L	L
L		H	H

Inputs			Outputs
$\overline{2OE}$	2CK	2D1-2D8	2Q1-2Q8
H	X	X	Z
L		X	Qn
L		L	L
L		H	H

X: Don't care

Z: High impedance

Qn: No change

## System Diagram

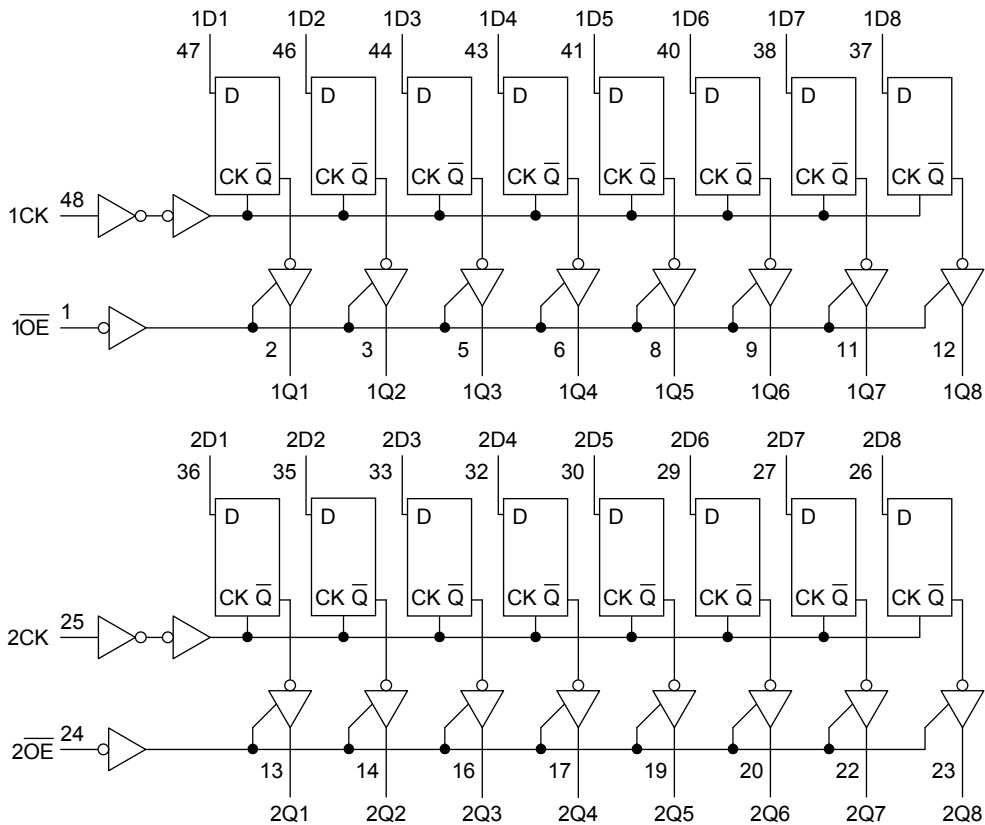

## Absolute Maximum Ratings (Note 1)

Characteristics	Symbol	Rating	Unit
Power supply voltage	$V_{CC}$	-0.5 to 6.0	V
Input voltage	$V_{IN}$	-0.5 to 7.0	V
Output voltage	$V_{OUT}$	-0.5 to 7.0 (Note 2)	V
		-0.5 to $V_{CC} + 0.5$ (Note 3)	
Input diode current	$I_{IK}$	-50	mA
Output diode current	$I_{OK}$	±50 (Note 4)	mA
DC output current	$I_{OUT}$	±50	mA
Power dissipation	$P_D$	400	mW
DC $V_{CC}$ /ground current per supply pin	$I_{CC}/I_{GND}$	±100	mA
Storage temperature	$T_{stg}$	-65 to 150	°C

Note 1: Exceeding any of the absolute maximum ratings, even briefly, lead to deterioration in IC performance or even destruction.

Using continuously under heavy loads (e.g. the application of high temperature/current/voltage and the significant change in temperature, etc.) may cause this product to decrease in the reliability significantly even if the operating conditions (i.e. operating temperature/current/voltage, etc.) are within the absolute maximum ratings and the operating ranges.

Please design the appropriate reliability upon reviewing the Toshiba Semiconductor Reliability Handbook (“Handling Precautions”/“Derating Concept and Methods”) and individual reliability data (i.e. reliability test report and estimated failure rate, etc).

Note 2: Output in OFF state

Note 3: High or low state.  $I_{OUT}$  absolute maximum rating must be observed.

Note 4:  $V_{OUT} < GND$ ,  $V_{OUT} > V_{CC}$

## Operating Ranges (Note 1)

Characteristics	Symbol	Rating	Unit
Power supply voltage	$V_{CC}$	2.0 to 3.6	V
		1.5 to 3.6 (Note 2)	
Input voltage	$V_{IN}$	0 to 5.5	V
Output voltage	$V_{OUT}$	0 to 5.5 (Note 3)	V
		0 to $V_{CC}$ (Note 4)	
Output current	$I_{OH}/I_{OL}$	±24 (Note 5)	mA
		±12 (Note 6)	
		±8 (Note 7)	
Operating temperature	$T_{opr}$	-40 to 85	°C
Input rise and fall time	$dt/dv$	0 to 10 (Note 8)	ns/V

Note 1: The operating ranges must be maintained to ensure the normal operation of the device. Unused inputs must be tied to either  $V_{CC}$  or GND.

Note 2: Data retention only

Note 3: Output in OFF state

Note 4: High or low state

Note 5:  $V_{CC} = 3.0$  to 3.6 V

Note 6:  $V_{CC} = 2.7$  to 3.0 V

Note 7:  $V_{CC} = 2.3$  to 2.7 V

Note 8:  $V_{IN} = 0.8$  to 2.0 V,  $V_{CC} = 3.0$  V

## Electrical Characteristics

### DC Characteristics (Ta = -40 to 85°C)

Characteristics		Symbol	Test Condition		V <sub>CC</sub> (V)	Min	Max	Unit	
Input voltage	H-level	V <sub>IH</sub>	—		2.3 to 2.7	1.7	—	V	
					2.7 to 3.6	2.0	—		
	L-level	V <sub>IL</sub>			2.3 to 2.7	—	0.7		
					2.7 to 3.6	—	0.8		
Output voltage	H-level	V <sub>OH</sub>	V <sub>IN</sub> = V <sub>IH</sub> or V <sub>IL</sub>		I <sub>OH</sub> = -100 μA	2.3 to 3.6	V <sub>CC</sub> - 0.2	—	V
					I <sub>OH</sub> = -8 mA	2.3	1.8	—	
					I <sub>OH</sub> = -12 mA	2.7	2.2	—	
					I <sub>OH</sub> = -18 mA	3.0	2.4	—	
					I <sub>OH</sub> = -24 mA	3.0	2.2	—	
	L-level	V <sub>OL</sub>			I <sub>OL</sub> = 100 μA	2.3 to 3.6	—	0.2	
					I <sub>OL</sub> = 8 mA	2.3	—	0.6	
					I <sub>OL</sub> = 12 mA	2.7	—	0.4	
					I <sub>OL</sub> = 16 mA	3.0	—	0.4	
					I <sub>OL</sub> = 24 mA	3.0	—	0.55	
Input leakage current		I <sub>IN</sub>	V <sub>IN</sub> = 0 to 5.5 V		2.3 to 3.6	—	±5.0	μA	
3-state output OFF state current		I <sub>OZ</sub>	V <sub>IN</sub> = V <sub>IH</sub> or V <sub>IL</sub> V <sub>OUT</sub> = 0 to 5.5 V		2.3 to 3.6	—	±5.0	μA	
Power-off leakage current		I <sub>OFF</sub>	V <sub>IN</sub> /V <sub>OUT</sub> = 5.5 V		0	—	10.0	μA	
Quiescent supply current		I <sub>CC</sub>	V <sub>IN</sub> = V <sub>CC</sub> or GND		2.3 to 3.6	—	20.0	μA	
			V <sub>IN</sub> /V <sub>OUT</sub> = 3.6 to 5.5 V		2.3 to 3.6	—	±20.0		
Increase in I <sub>CC</sub> per input		ΔI <sub>CC</sub>	V <sub>IH</sub> = V <sub>CC</sub> - 0.6 V		2.3 to 3.6	—	500		

## AC Characteristics (Ta = -40 to 85°C)

Characteristics	Symbol	Test Condition	Test Condition		Min	Max	Unit
			V <sub>CC</sub> (V)	CL(pF)			
Maximum clock frequency	f <sub>max</sub>	Figure 1, Figure 2	2.5 ± 0.2	30	—	—	MHz
			2.7	50	—	—	
			3.3 ± 0.3	50	170	—	
Propagation delay time (CK-Q)	t <sub>pLH</sub> t <sub>pHL</sub>	Figure 1, Figure 2	2.5 ± 0.2	30	1.5	7.4	ns
			2.7	50	1.5	6.5	
			3.3 ± 0.3	50	1.5	6.2	
3-state output enable time	t <sub>pZL</sub> t <sub>pZH</sub>	Figure 1, Figure 3	2.5 ± 0.2	30	1.5	7.9	ns
			2.7	50	1.5	6.3	
			3.3 ± 0.3	50	1.5	6.1	
3-state output disable time	t <sub>pLZ</sub> t <sub>pHZ</sub>	Figure 1, Figure 3	2.5 ± 0.2	30	1.5	7.2	ns
			2.7	50	1.5	6.2	
			3.3 ± 0.3	50	1.5	6.0	
Minimum pulse width (CK)	t <sub>w</sub> (H) t <sub>w</sub> (L)	Figure 1, Figure 2	2.5 ± 0.2	30	3.5	—	ns
			2.7	50	3.0	—	
			3.3 ± 0.3	50	3.0	—	
Minimum setup time	t <sub>s</sub>	Figure 1, Figure 2	2.5 ± 0.2	30	3.0	—	ns
			2.7	50	2.5	—	
			3.3 ± 0.3	50	2.5	—	
Minimum hold time	t <sub>h</sub>	Figure 1, Figure 2	2.5 ± 0.2	30	2.0	—	ns
			2.7	50	1.5	—	
			3.3 ± 0.3	50	1.5	—	
Output to output skew	t <sub>osLH</sub> t <sub>osHL</sub>	(Note)	2.5 ± 0.2	30	—	—	ns
			2.7	50	—	—	
			3.3 ± 0.3	50	—	1.0	

Note: Parameter guaranteed by design.  
 (t<sub>osLH</sub> = |t<sub>pLHm</sub> - t<sub>pLHn</sub>|, t<sub>osHL</sub> = |t<sub>pHLm</sub> - t<sub>pHLn</sub>|)

## Dynamic Switching Characteristics (Ta = 25°C, input: t<sub>r</sub> = t<sub>f</sub> = 2.5 ns, R<sub>L</sub> = 500 Ω)

Characteristics	Symbol	Test Condition	Test Condition		Typ.	Unit
			V <sub>CC</sub> (V)			
Quiet output maximum dynamic V <sub>OL</sub>	V <sub>OLP</sub>	V <sub>IH</sub> = 2.5 V, V <sub>IL</sub> = 0 V, C <sub>L</sub> = 30pF	2.5	0.6	V	
			3.3	0.8		
Quiet output minimum dynamic V <sub>OL</sub>	V <sub>OLV</sub>	V <sub>IH</sub> = 2.5 V, V <sub>IL</sub> = 0 V, C <sub>L</sub> = 30pF	2.5	0.6	V	
			3.3	0.8		

**Capacitive Characteristics (Ta = 25°C)**

Characteristics	Symbol	Test Condition	V <sub>CC</sub> (V)	Typ.	Unit
Input capacitance	C <sub>IN</sub>	—	3.3	7	pF
Output capacitance	C <sub>OUT</sub>	—	3.3	8	pF
Power dissipation capacitance	C <sub>PD</sub>	f <sub>IN</sub> = 10 MHz (Note)	3.3	25	pF

Note: C<sub>PD</sub> is defined as the value of the internal equivalent capacitance which is calculated from the operating current consumption without load.

Average operating current can be obtained by the equation:

$$I_{CC (opr)} = C_{PD} \cdot V_{CC} \cdot f_{IN} + I_{CC}/16 \text{ (per bit)}$$

**AC Test Circuit**

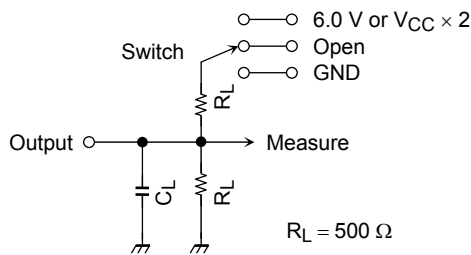

Parameter	Switch
t <sub>pLH</sub> , t <sub>pHL</sub>	Open
t <sub>pLZ</sub> , t <sub>pZL</sub>	6.0 V @V <sub>CC</sub> = 3.3 ± 0.3 V V <sub>CC</sub> × 2 @V <sub>CC</sub> = 2.5 ± 0.2 V
t <sub>pHZ</sub> , t <sub>pZH</sub>	GND

**Figure 1**

**AC Waveform**

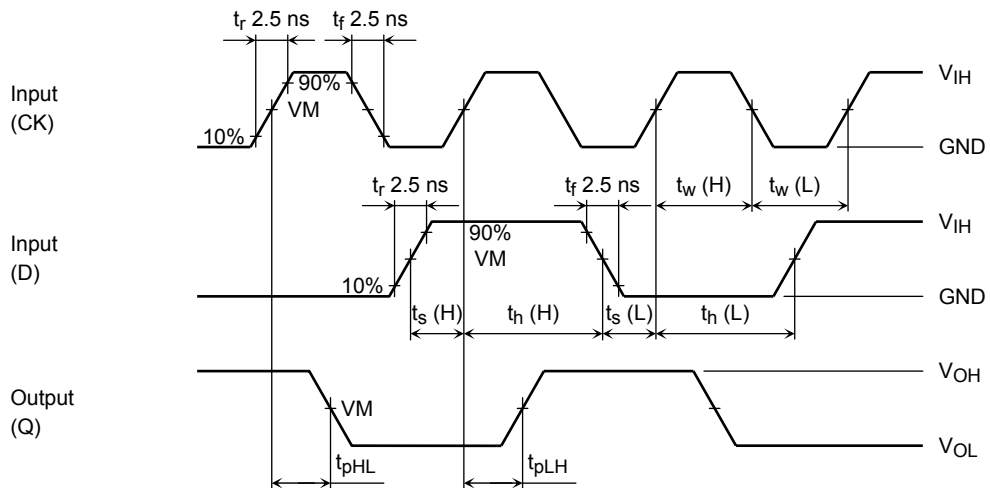

**Figure 2**  $t_{pLH}$ ,  $t_{pHL}$ ,  $t_w$ ,  $t_s$ ,  $t_h$

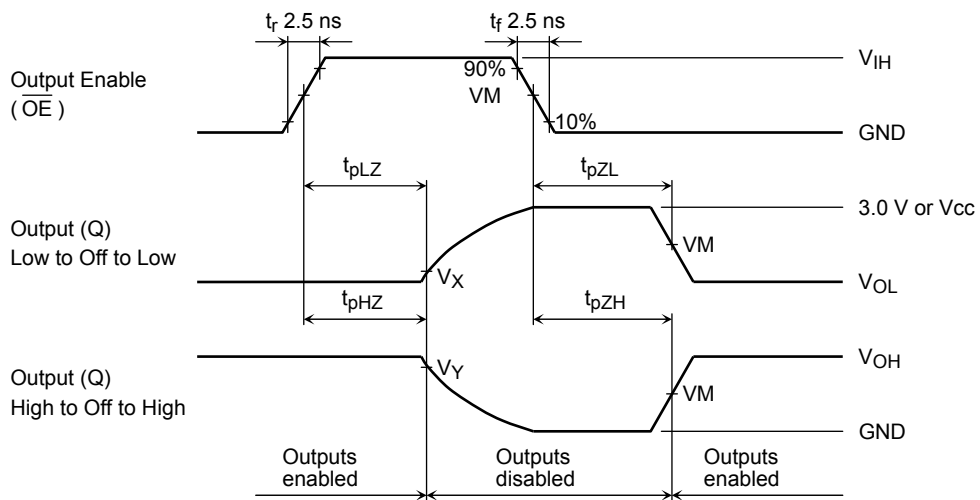

**Figure 3**  $t_{pLZ}$ ,  $t_{pHZ}$ ,  $t_{pZL}$ ,  $t_{pZH}$

Symbol	$V_{CC}$		
	$3.3 \pm 0.3 \text{ V}$	$2.7 \text{ V}$	$2.5 \pm 0.2 \text{ V}$
$V_{IH}$	$2.7 \text{ V}$	$2.7 \text{ V}$	$V_{CC}$
$V_M$	$1.5 \text{ V}$	$1.5 \text{ V}$	$V_{CC}/2$
$V_X$	$V_{OL} + 0.3 \text{ V}$	$V_{OL} + 0.3 \text{ V}$	$V_{OL} + 0.15 \text{ V}$
$V_Y$	$V_{OH} - 0.3 \text{ V}$	$V_{OH} - 0.3 \text{ V}$	$V_{OH} - 0.15 \text{ V}$



**Package Dimensions**

TSSOP48-P-0061-0.50A

Unit: mm

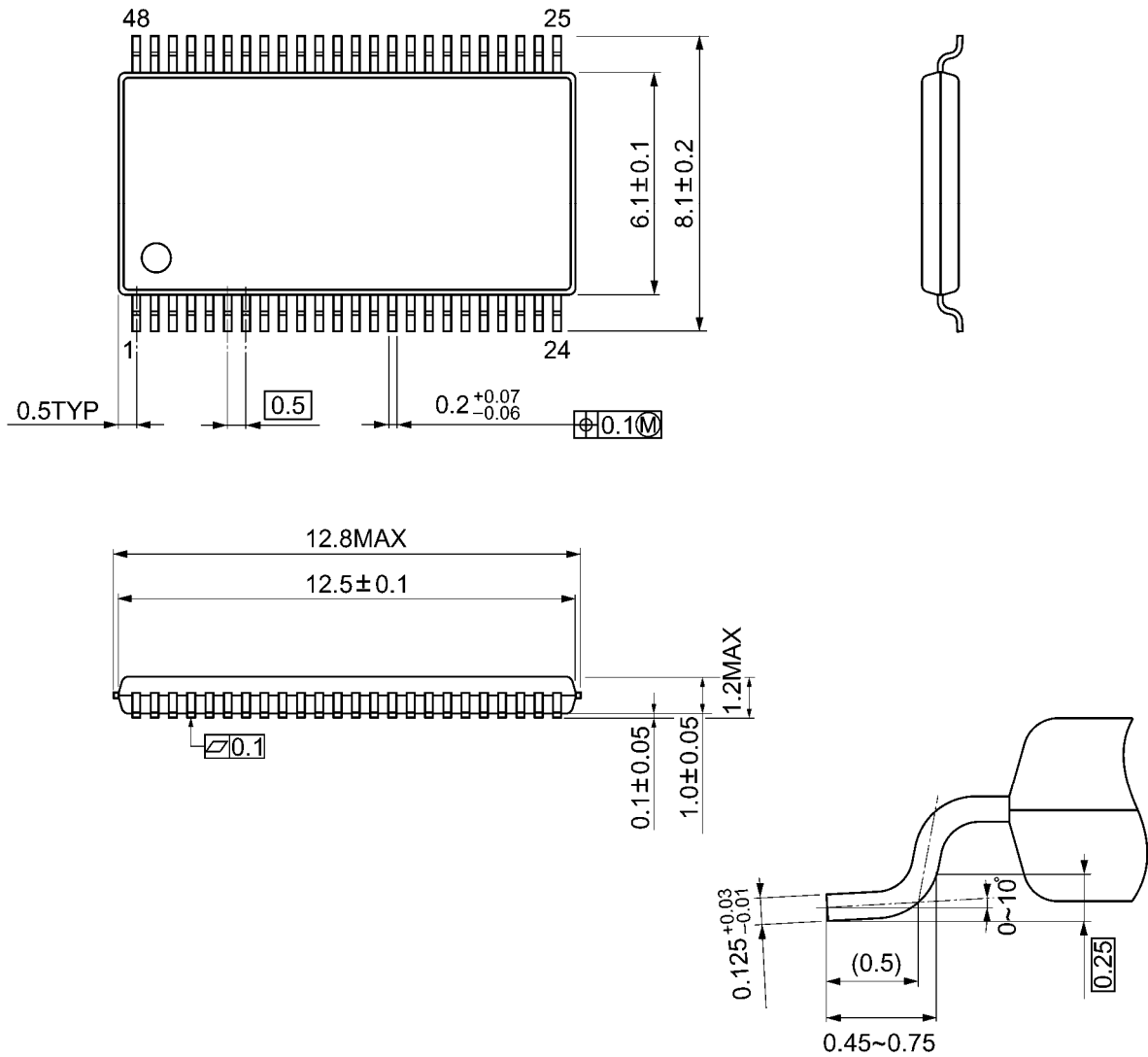

Weight: 0.25 g (typ.)

**RESTRICTIONS ON PRODUCT USE**

20070701-EN GENERAL

- The information contained herein is subject to change without notice.
- TOSHIBA is continually working to improve the quality and reliability of its products. Nevertheless, semiconductor devices in general can malfunction or fail due to their inherent electrical sensitivity and vulnerability to physical stress. It is the responsibility of the buyer, when utilizing TOSHIBA products, to comply with the standards of safety in making a safe design for the entire system, and to avoid situations in which a malfunction or failure of such TOSHIBA products could cause loss of human life, bodily injury or damage to property.  
In developing your designs, please ensure that TOSHIBA products are used within specified operating ranges as set forth in the most recent TOSHIBA products specifications. Also, please keep in mind the precautions and conditions set forth in the "Handling Guide for Semiconductor Devices," or "TOSHIBA Semiconductor Reliability Handbook" etc.
- The TOSHIBA products listed in this document are intended for usage in general electronics applications (computer, personal equipment, office equipment, measuring equipment, industrial robotics, domestic appliances, etc.). These TOSHIBA products are neither intended nor warranted for usage in equipment that requires extraordinarily high quality and/or reliability or a malfunction or failure of which may cause loss of human life or bodily injury ("Unintended Usage"). Unintended Usage include atomic energy control instruments, airplane or spaceship instruments, transportation instruments, traffic signal instruments, combustion control instruments, medical instruments, all types of safety devices, etc.. Unintended Usage of TOSHIBA products listed in this document shall be made at the customer's own risk.
- The products described in this document shall not be used or embedded to any downstream products of which manufacture, use and/or sale are prohibited under any applicable laws and regulations.
- The information contained herein is presented only as a guide for the applications of our products. No responsibility is assumed by TOSHIBA for any infringements of patents or other rights of the third parties which may result from its use. No license is granted by implication or otherwise under any patents or other rights of TOSHIBA or the third parties.
- Please contact your sales representative for product-by-product details in this document regarding RoHS compatibility. Please use these products in this document in compliance with all applicable laws and regulations that regulate the inclusion or use of controlled substances. Toshiba assumes no liability for damage or losses occurring as a result of noncompliance with applicable laws and regulations.