

HIGH POWER LED BULB

Data Sheet

Description:

These high power LED bulbs are specifically designed for flashlight electric equipment, indicator light switch and where a wide view angle. The 5mm round shaped radiation pattern (30°) and high luminous intensity ensure that these devices are excellent for wide field of view outdoor applications where a wide viewing angle and readability in sunlight are essential.

High efficiency LED materials are used in this Bulb. Every lamp is made with an advanced optical grade epoxy offering superior high shock and high temperature resistance in outdoor applications.

Feature:

- Wide view angle
- High luminous output
- Solid-state Vibration resistant
- Saving power
- Long life

Option:

- 24V AC/DC
- Other industry standard base.

A-BRIGHT

A-BRIGHT INDUSTRIAL CO.,LTD.

Part No.: AB-0351GA-24V0-M00-S

High Power LED Bulb

PACKAGE DIMENSIONS:

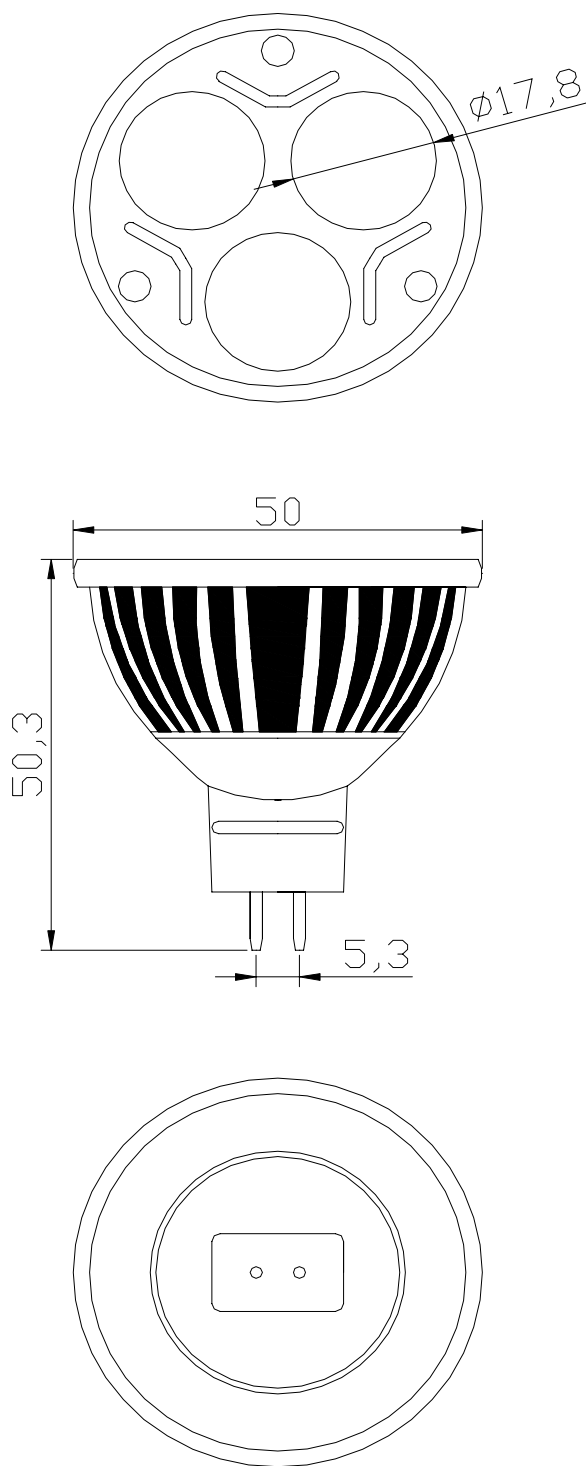

NOTE:

1. All dimensions are in millimeter.
2. Bulb base :MR16.
3. All tolerance are ± 0.5 mm.

Part No.: AB-0351GA-24V0-M00-S

High Power LED Bulb

FEATURE:

- 3x1W HI-POWER LED.
- SUPER LUMINOSITY SUPER GREEN LED (InGaN).
- WATER CLEAR PACKAGE.
- USING COPPER, HIGH PRECISION OPTICAL GLASS, ELECTRONIC CERAMIC AND OTHER RAW MATERIALS.
- WIDE VIEWING ANGLE.
- BASE MODEL MR16.
- ELECTRIC AC/DC BI-POLAR.
- RoHS APPROVALS.

ABSOLUTE MAXIMUM RATING: Ta = 25 °C

- OPERATING FREQUENCY 50 TO 60 Hz
- OPERATING TEMPERATURE..... -20 TO +40°C
- STORAGE TEMPERATURE..... -40 TO +85°C
- LED BULB LIFE..... 30000 HOURS

ABSOLUTE OPTICAL CHARACTERISTIC Ta= 25°C

- Lamp house Material/Parameter

Spec.	Input Voltage	LED Q'TY	Emitting Color	Dominant Wavelength	Luminous Flux		Forward Voltage		View Angle
				Typ.	Min.	Typ.	Typ.	Max.	Typ.
LED	24V (AC/DC)	3	GREEN	530	---	60	12	16	30