

AKD4552-A
Evaluation board Rev.0 for AK4552

GENERAL DESCRIPTION

AKD4552-A is an evaluation board for the digital audio 24bit A/D and D/A converter, AK4552. The AKD4552-A can evaluate A/D converter and D/A converter separately in addition to loopback mode (A/D → D/A). The A/D section can be evaluated by interfacing with AKM's DAC evaluation boards directly. The AKD4552-A has the interface with AKM's ADC evaluation boards. Therefore, it's easy to evaluate the D/A section. The AKD4552-A also has the digital audio interface and can achieve the interface with digital audio systems via opt-conductor.

■ Ordering guide

AKD4552-A --- Evaluation board for AK4552

FUNCTION

- DIT/DIR with optical input/output
- BNC connector for an external clock input

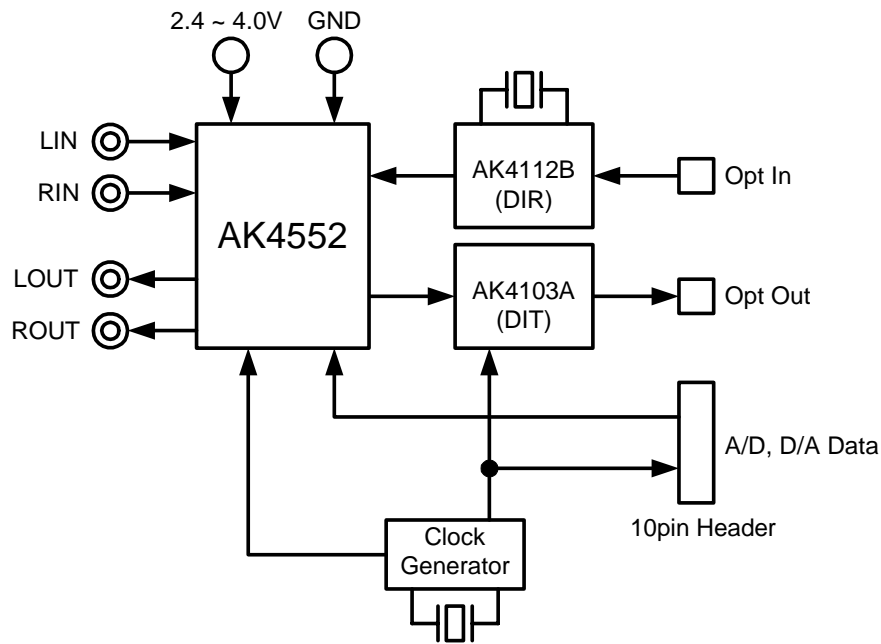

Figure 1. AKD4552-A Block Diagram

* Circuit diagram and PCB layout are attached at the end of this manual.

■ Analog Input Circuit

External analog signal fed through the BNC connector is terminated by a resistor of 560 ohms. The resistor value should be properly selected in order to meet the output impedance of the signal source.

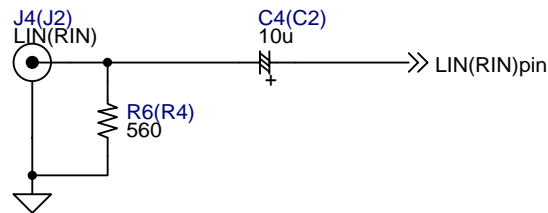

Figure 2. Input buffer circuit on board

* AKM assumes no responsibility for the trouble when using the circuit examples.

■ Analog Output Circuit

The AK4552 includes a combination of switched-capacitor filter (SCF) and continuous-time filter (CTF), so any external filters are not required.

■ Operation sequence

1) Set up the power supply lines.

[VA]	(orange)	= 2.4 ~ 4.0V	: for VA of AK4552 (typ. 3.0V)
[D2V]	(orange)	= 2.4 ~ 4.0V	: for D2V of 74LVC541 (typ. 3.0V)
[VCC]	(red)	= 3.6 ~ 5.0V	: for logic
[AGND]	(black)	= 0V	: for analog ground (including VSS of AK4552)
[DGND]	(black)	= 0V	: for logic ground

Each supply line should be distributed from the power supply unit.
D2V and VA must be same voltage level.

2) Set up the evaluation mode, jumper pins and DIP switches. (See the followings.)

3) Power on.

The AK4552 should be reset once bringing SW1 (PDN) "L" upon power-up.

■ Evaluation mode

Applicable Evaluation Mode

- (1) Evaluation of A/D using DIT (Optical Link)
- (2) Evaluation of D/A using DIR (Optical Link)
- (3) Evaluation of loopback mode (default)
- (4) Evaluation of D/A using A/D converted data
- (5) Evaluation of A/D using D/A converted data
- (6) All interface signals including master clock are fed externally.

(1) Evaluation of A/D using DIT (Optical Link)

PORT2 (DIT) and X2 (X'tal) is used. DIT generates audio bi-phase signal from received data and which is output through optical connector (TOTX176). It is possible to connect AKM's D/A converter evaluation boards on the digital-amplifier which equips DIR input. Nothing should be connected to PORT1 (DIR), PORT3 (ROM). In case of using external clock through a BNC connector (J5), select EXT on JP11 (CLK) and short JP8 (XTE) and open JP13 (EXT). AK4112B should be powered down.

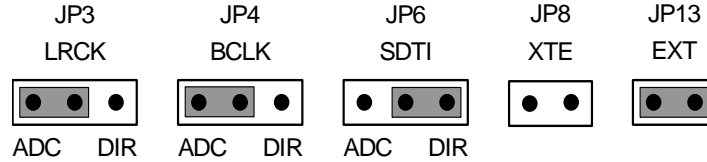

• Clock example

1-1) Normal speed of ADC (MCLK=256fs)

Master clock frequency example of X2 : X2 = 8.192MHz, 11.2896MHz, 12.288MHz

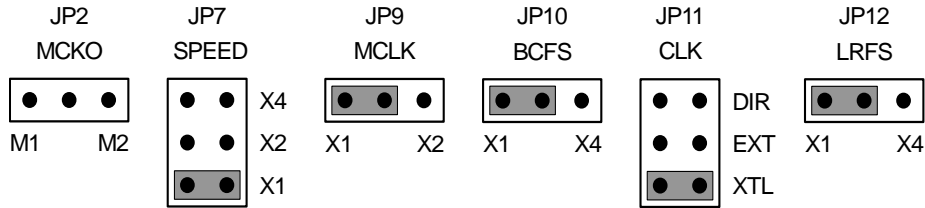

1-2) Normal speed of ADC (MCLK=512fs)

Master clock frequency example of X2 : X2 = 16.384MHz, 22.5792MHz, 24.576MHz

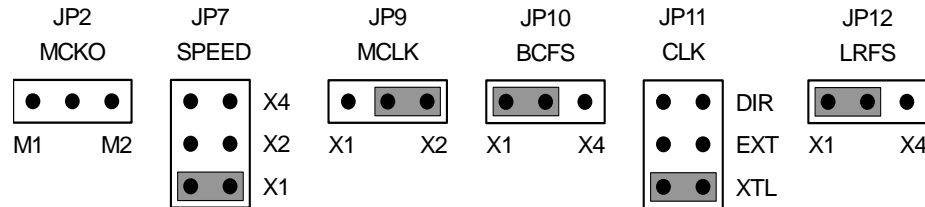

1-3) Double speed of ADC (MCLK=256fs)

Master clock frequency example of X2 : X2 = 16.384MHz, 22.5792MHz, 24.576MHz

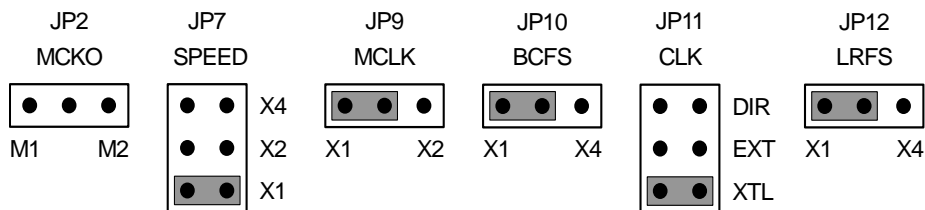

(2) Evaluation of D/A using DIR (Optical Link)

PORT1 (DIR) is used. DIR generates MCLK, BCLK, LRCK and SDATA from the received data through optical connector (TORX176). Used for the evaluation using CD test disk. Nothing should be connected to PORT3 (ROM). Set up "H" (AK4112B : PLL mode) for SW2-5 (CM0).



• Clock example

2-1) Normal speed of DAC (MCLK=256fs)

Input fs example for PORT1 : fs = 32kHz, 44.1kHz, 48kHz

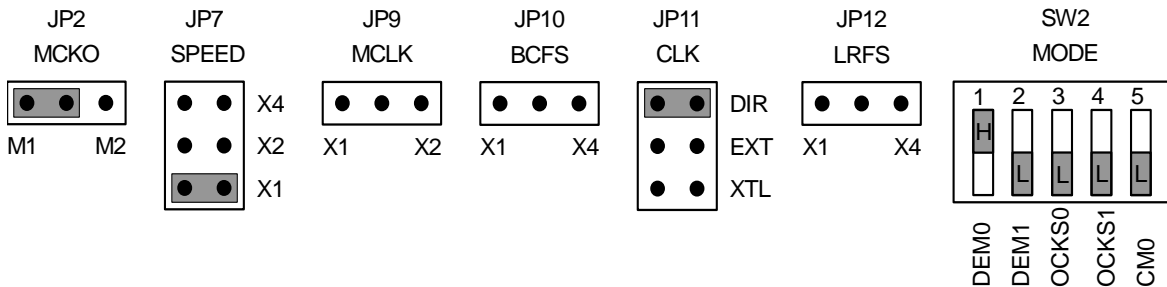

2-2) Normal speed of DAC (MCLK=512fs)

Input fs example for PORT1 : fs = 32kHz, 44.1kHz, 48kHz

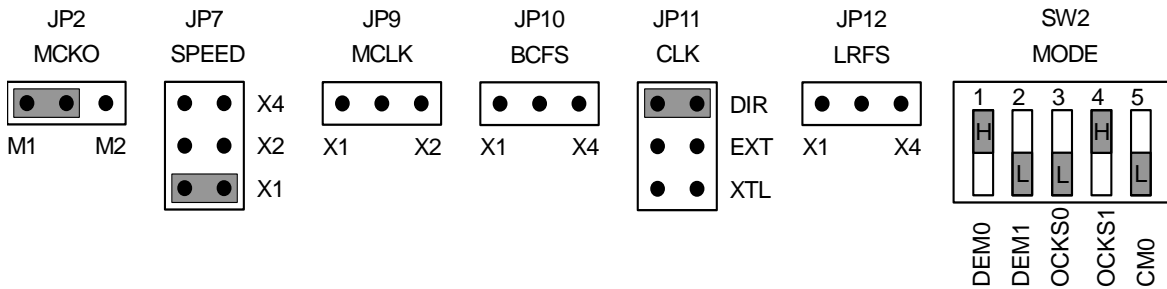

2-3) Double speed of DAC (MCLK=256fs)

Input fs example for PORT1 : fs = 64kHz, 88.2kHz, 96kHz

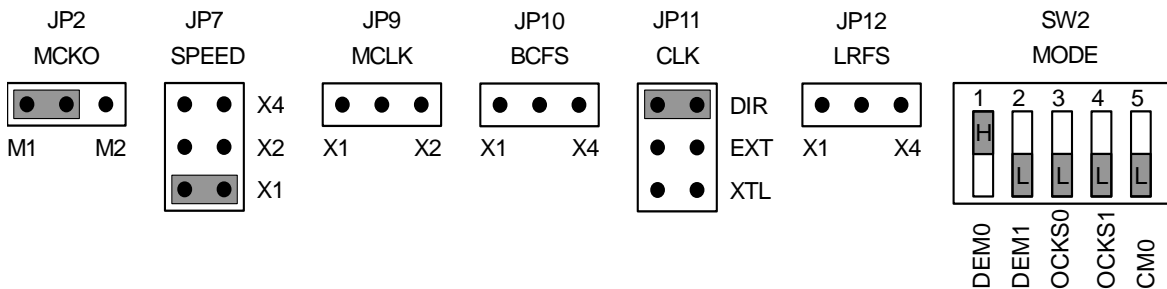

2-4) 1/2 decimation of DAC (MCLK=128fs)

Input fs example for PORT1 : fs = 64kHz, 88.2kHz, 96kHz

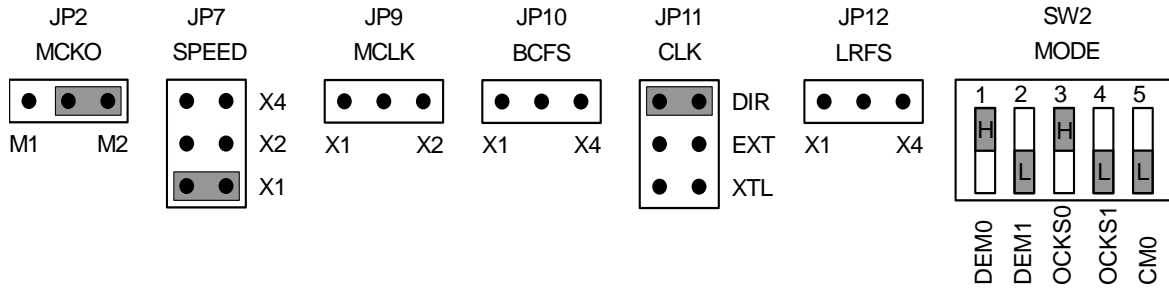

(3) Evaluation of loopback mode (default)

Using U4 (AK4112B) and X1 (X'tal). Nothing should be connected to PORT1 (DIR), PORT3 (ROM). Set up "H" (AK4112B : X'tal mode) for SW2-5 (CM0).

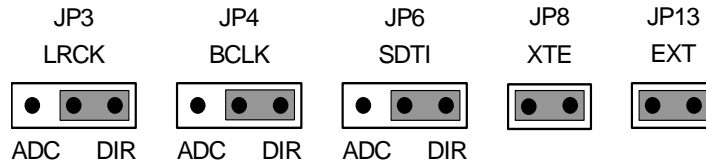

• Clock example

3-1) Normal speed (MCLK=256fs)

Master clock frequency example of X1 : X1 = 8.192MHz, 11.2896MHz, 12.288MHz

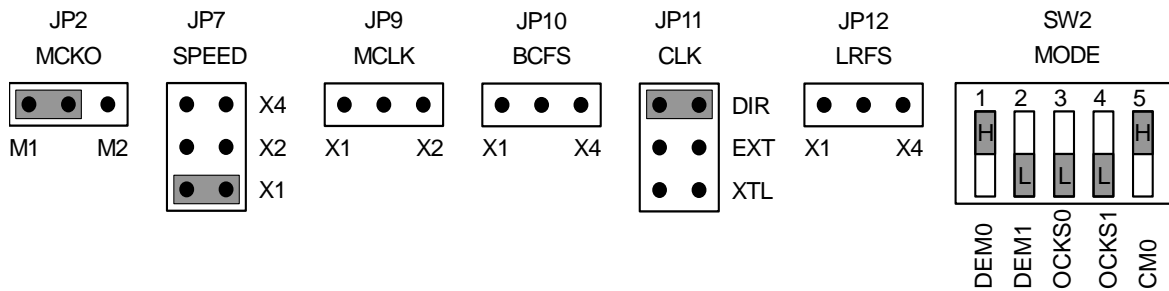

3-2) Normal speed (MCLK=512fs)

Master clock frequency example of X1 : X1 = 16.384MHz, 22.5792MHz, 24.576MHz

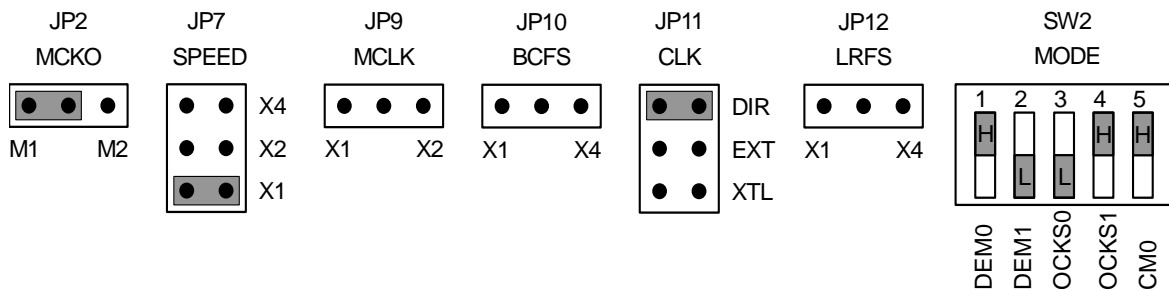

3-3) Double speed (MCLK=256fs)

Master clock frequency example of X1 : X1 = 16.384MHz, 22.5792MHz, 24.576MHz

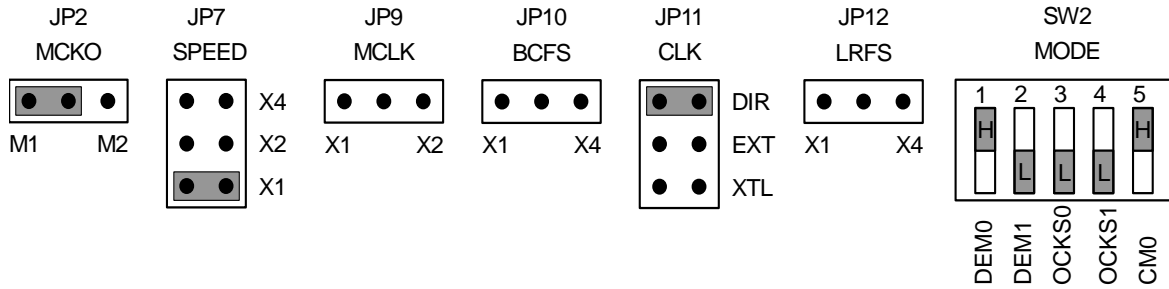

(4) Evaluation of D/A using A/D converted data

It is possible to make evaluation in the form of analog inputs and analog outputs by interfacing with various AKM's A/D evaluation boards with PORT3 (ROM). Nothing should be connected to PORT1 (DIR). In case of using external clock through a BNC connector (J5), select EXT on JP11 (CLK) and short JP8 (XTE) and open JP13 (EXT). This mode corresponds to normal speed only.

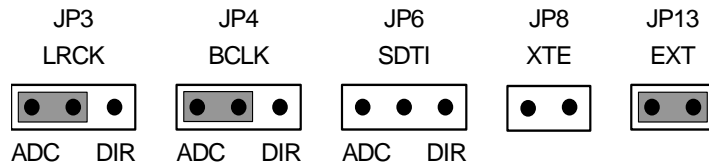

• Clock example

4-1) Normal speed of DAC (MCLK=256fs)

Master clock frequency example of X2 : X2 = 8.192MHz, 11.2896MHz, 12.288MHz

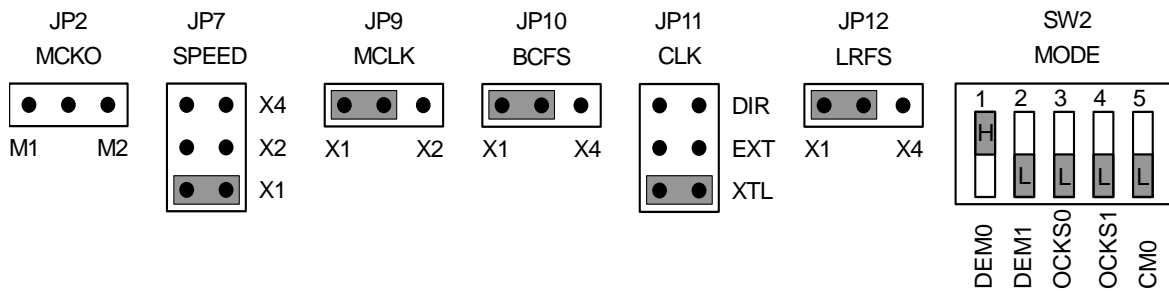

4-2) Normal speed of DAC (MCLK=512fs)

Master clock frequency example of X2 : X2 = 16.384MHz, 22.5792MHz, 24.576MHz

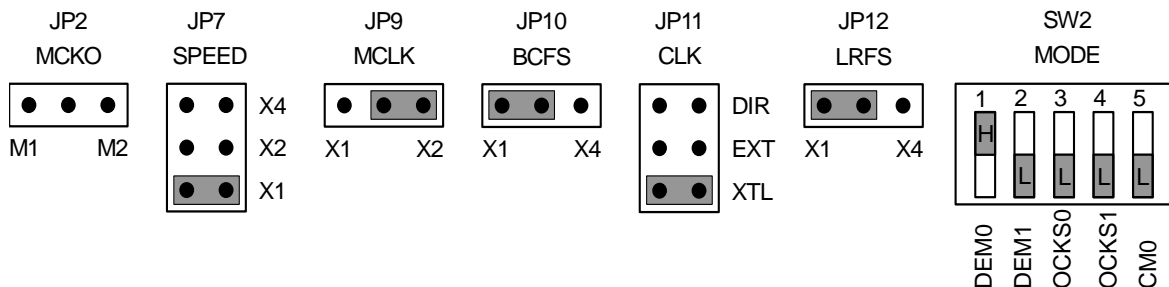

(5) Evaluation of A/D using D/A converted data

It is possible to make evaluation in the form of analog inputs and analog outputs by interfacing with various AKM's D/A evaluation boards with PORT3 (ROM). Nothing should be connected to PORT1 (DIR).

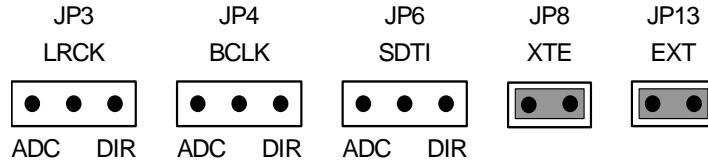

• Clock example

5-1) Normal speed of ADC (MCLK=256fs)
Do not use X2.

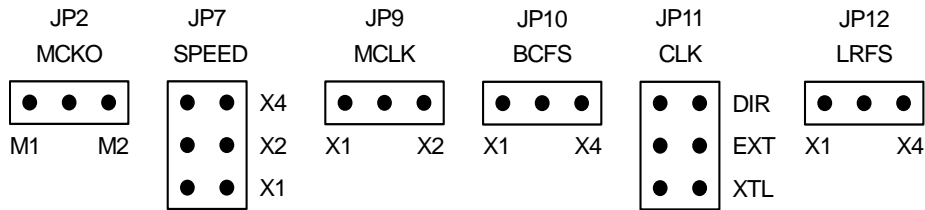

5-2) Normal speed of ADC (MCLK=512fs)
Do not use X2.

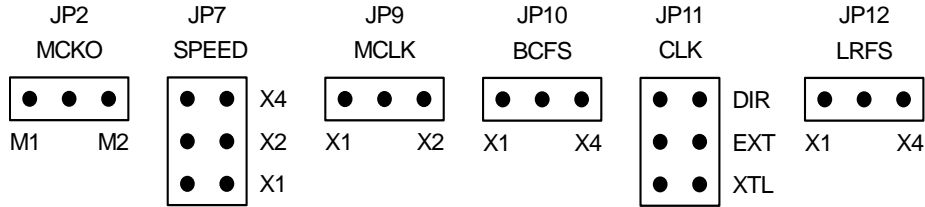

(6) All interface signals including master clock are fed externally.

Under the following set-up, all external signals needed for the AK4552 to operate could be fed through PORT3 (ROM). In case of interfacing external sources to D/A converter, JP6 (SDTI) should be open. And in case of using A/D data to externally, JP6 (SDTI) is set ADC side. When JP6 (SDTI) is open, the A/D data can be output from the SDTO pin of PORT3 (ROM) at the same time if JP5 (SDTO) is short.

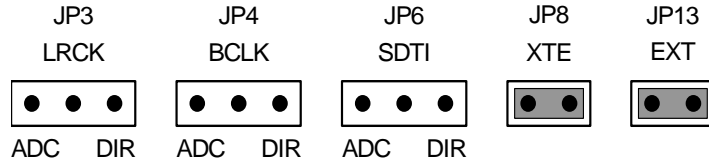

• Clock example

6-1) Normal speed, Double speed, 4 times speed of ADC and DAC
Do not use X2.

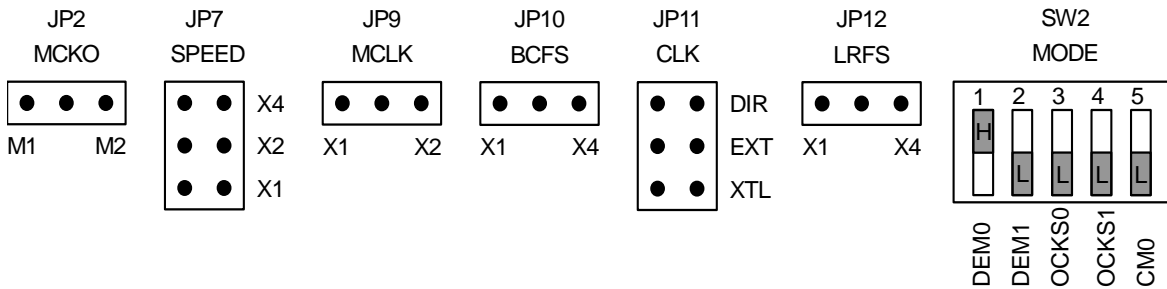

■ DIP switch set up

Upper-side is “H” and lower-side is “L”.

[SW2] (MODE) : Sets the de-emphasis filter of AK4552 and clock mode of U4 (AK4112B).

No.	Pin Name	Mode
1	DEM0	See Table 2.
2	DEM1	
3	OCKS0	See Table 3.
4	OCKS1	
5	CM0	L : X'tal mode, H : PLL mode

Table 1. Set up SW2

DEM1	DEM0	Mode
L	L	44.1kHz
L	H	OFF
H	L	48kHz
H	H	32kHz

default

Table 2. Set up of DEM0/1 of AK4552

No.	OCKS1	OCKS0	MCKO1	MCKO2	fs (kHz)
0	L	L	256fs	256fs	32, 44.1, 48, 96
1	H	L	512fs	128fs	32, 44.1, 48

Table 3. Set up of OCKS0/1 for AK4112B

■ Other jumper pins set up

[JP1] (GND): Analog ground and digital ground

open: separated

short: common (The connector “DGND” can be open.) <default>

[JP5] (SDTO): SDTO of AK4552

Always open. It is possible to short for evaluation mode 6.

■ The function of the toggle SW

Upper-side is “H” and lower-side is “L”.

[SW1] (PDN): Resets the AK4552. Keep “H” during normal operation.

[SW3] (DIR): Resets the AK4112B. Keep “H” during normal operation.

[SW4] (DIT): Resets the AK4103A. Keep “H” during normal operation.

■ Indication for LED

[LED1] (ERF): Monitor ERF pin of the AK4112B. LED turns on when some error has occurred to AK4112B.

MEASUREMENT RESULTS

[Measurement condition]

- Measurement unit : Audio Precision, System two Cascade
- MCLK : 256fs
- BCLK : 64fs
- fs : 32kHz, 44.1kHz, 48kHz, 96kHz
- Bit : 24bit
- Band width : ADC : 10Hz ~ 20kHz (Normal Speed), 10Hz ~ 48kHz (Double Speed)
- Measurement Filter : DAC : 10Hz ~ 20kHz (Normal Speed), 10Hz ~ 40kHz (Double Speed)
- Power Supply : VA = VD = 3.0V
- Interface : DIT/DIR
- Temperature : Room

Parameter		Result (Lch / Rch)	Unit
ADC Analog Input Characteristics			
S/(N+D) (-0.5dB Input)	fs=32kHz	87.8 / 87.9	dB
	fs=44.1kHz	88.5 / 88.5	dB
	fs=48kHz	89.2 / 89.2	dB
	fs=96kHz	89.5 / 89.4	dB
D-Range (-60dB Input)	fs=32kHz, A-weighted	96.1 / 96.1	dB
	fs=44.1kHz, A-weighted	97.1 / 97.1	dB
	fs=48kHz, A-weighted	97.5 / 97.5	dB
	fs=96kHz	93.3 / 93.3	dB
S/N	fs=32kHz, A-weighted	96.1 / 96.1	dB
	fs=44.1kHz, A-weighted	97.1 / 97.1	dB
	fs=48kHz, A-weighted	97.6 / 97.6	dB
	fs=96kHz	93.3 / 93.3	dB
Interchannel Isolation		118.5 / 118.7	dB
DAC Analog Output Characteristics			
S/(N+D) (0dB Output)	fs=32kHz	88.3 / 89.2	dB
	fs=44.1kHz	88.1 / 88.8	dB
	fs=48kHz	88.3 / 89.2	dB
	fs=96kHz	85.6 / 86.3	dB
D-Range (-60dB Output)	fs=32kHz, A-weighted	100.0 / 100.0	dB
	fs=44.1kHz, A-weighted	100.4 / 100.4	dB
	fs=48kHz, A-weighted	100.6 / 100.6	dB
	fs=96kHz	95.6 / 95.6	dB
S/N	fs=32kHz, A-weighted	100.9 / 100.9	dB
	fs=44.1kHz, A-weighted	101.6 / 101.6	dB
	fs=48kHz, A-weighted	101.6 / 101.6	dB
	fs=96kHz	96.0 / 96.0	dB
Interchannel Isolation		116.2 / 116.4	dB

1. ADC (Normal Speed)

AKM

AK4552 ADC THD+N vs. Input Level
VA=VD=3.0V, fs=44.1kHz, fin=1kHz

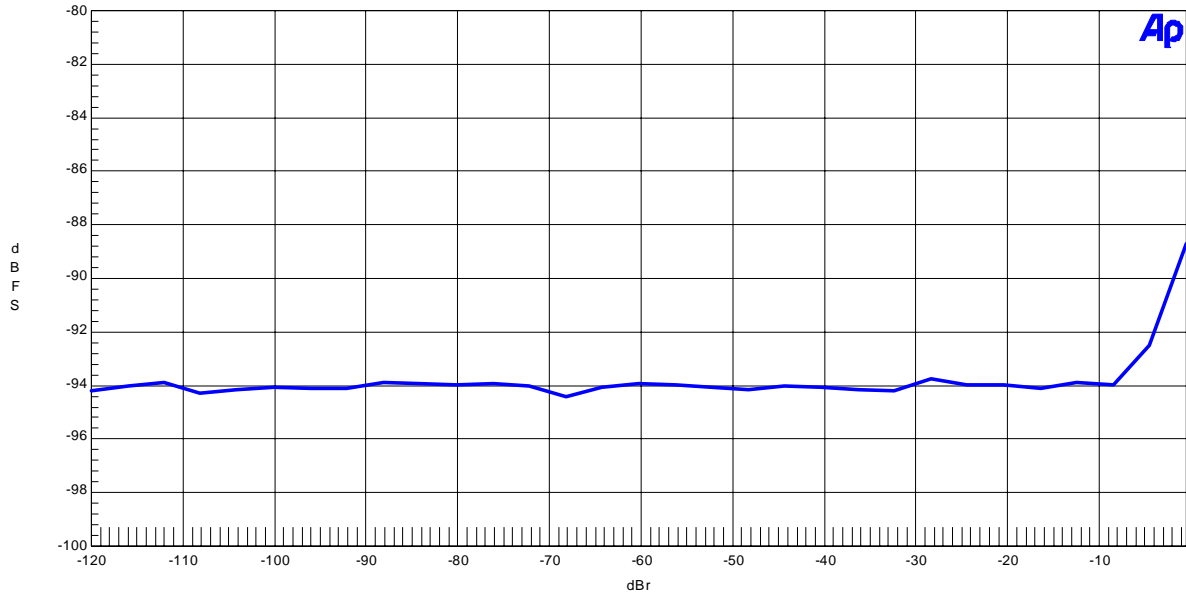

Figure 1. THD+N vs. Input Level

AKM

AK4552 ADC THD+N vs. Input Frequency
VA=VD=3.0V, fs=44.1kHz, Input=-0.5dBr

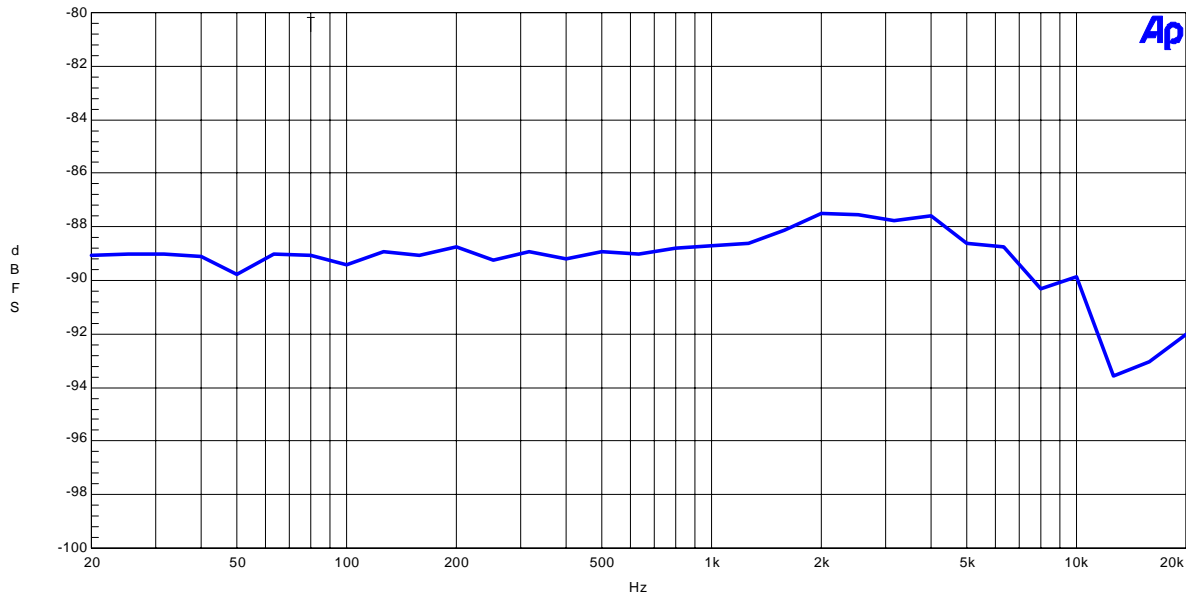

Figure 2. THD+N vs. Input Frequency

AKM

AK4552 ADC Linearity
VA=VD=3.0V, fs=44.1kHz, fin=1kHz

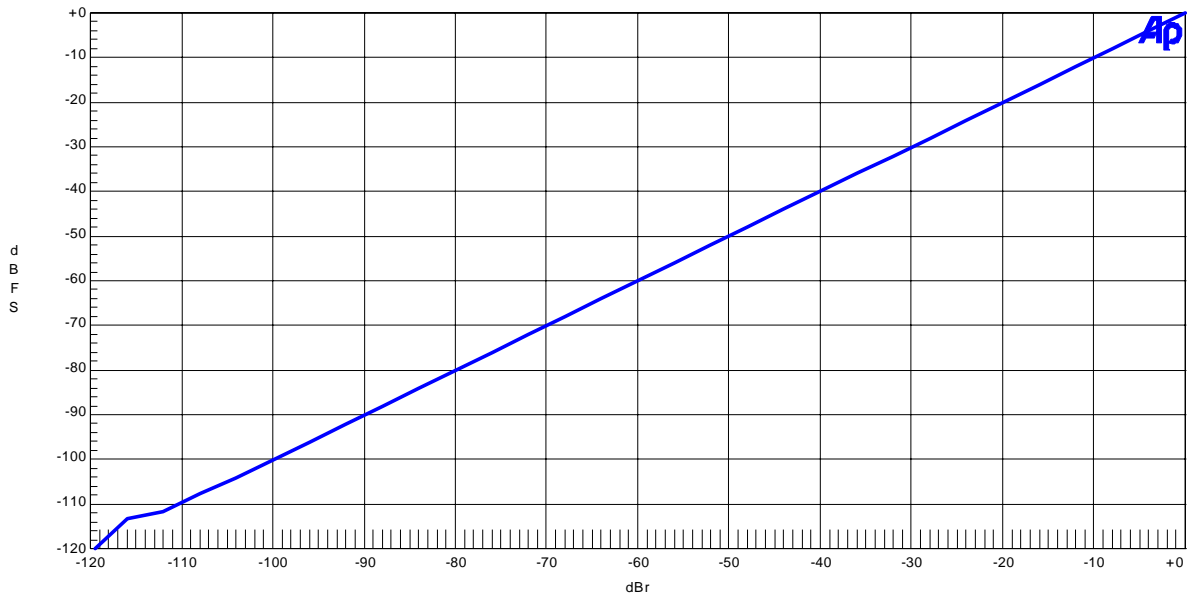

Figure 3. Linearity

AKM

AK4552 ADC Frequency Response
VA=VD=3.0V, fs=44.1kHz, Input=-0.5dBr

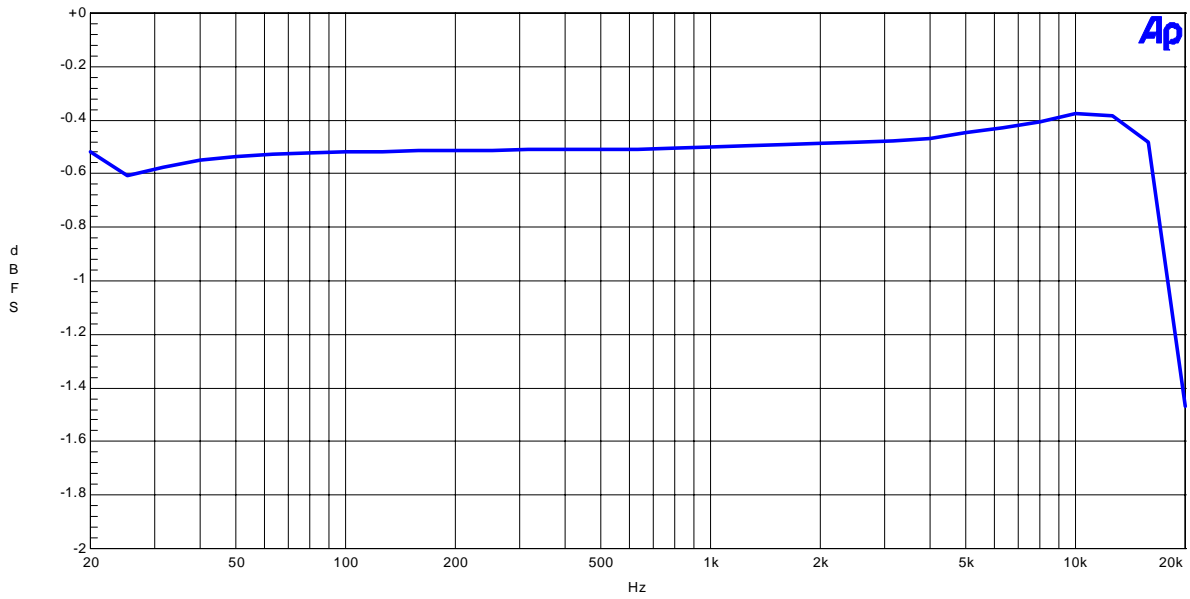

Figure 4. Frequency Response

AKM

AK4552 ADC Crosstalk
VA=VD=3.0V, fs=44.1kHz, Input=-0.5dBr

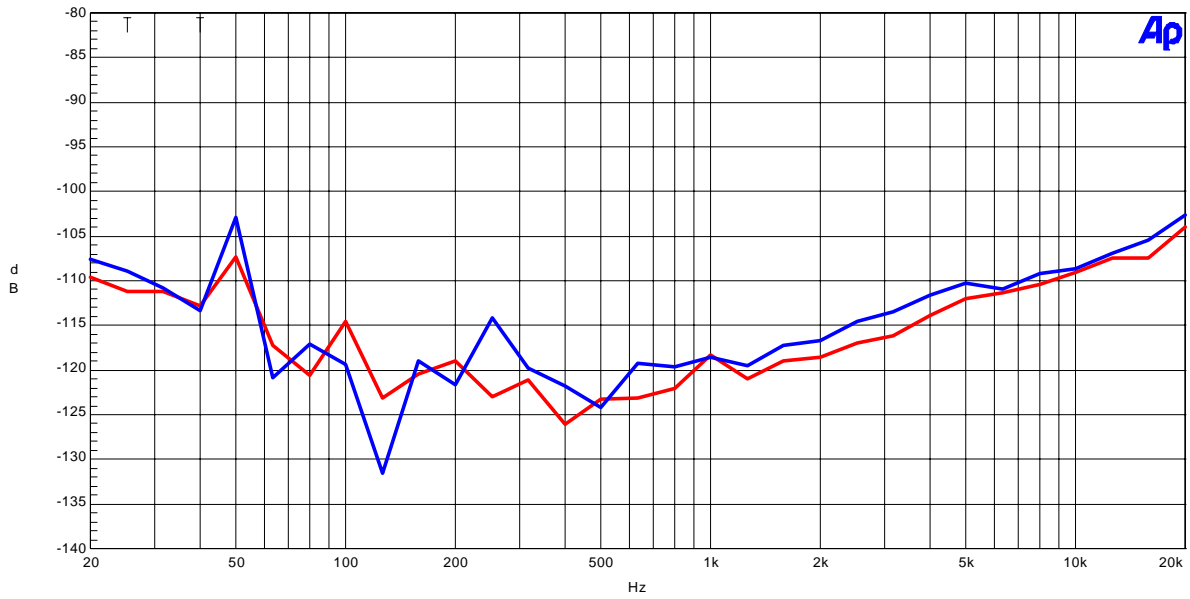

Figure 5. Crosstalk

AKM

AK4552 ADC FFT Plot
VA=VD=3.0V, fs=44.1kHz, Input=-0.5dBr, fin=1kHz

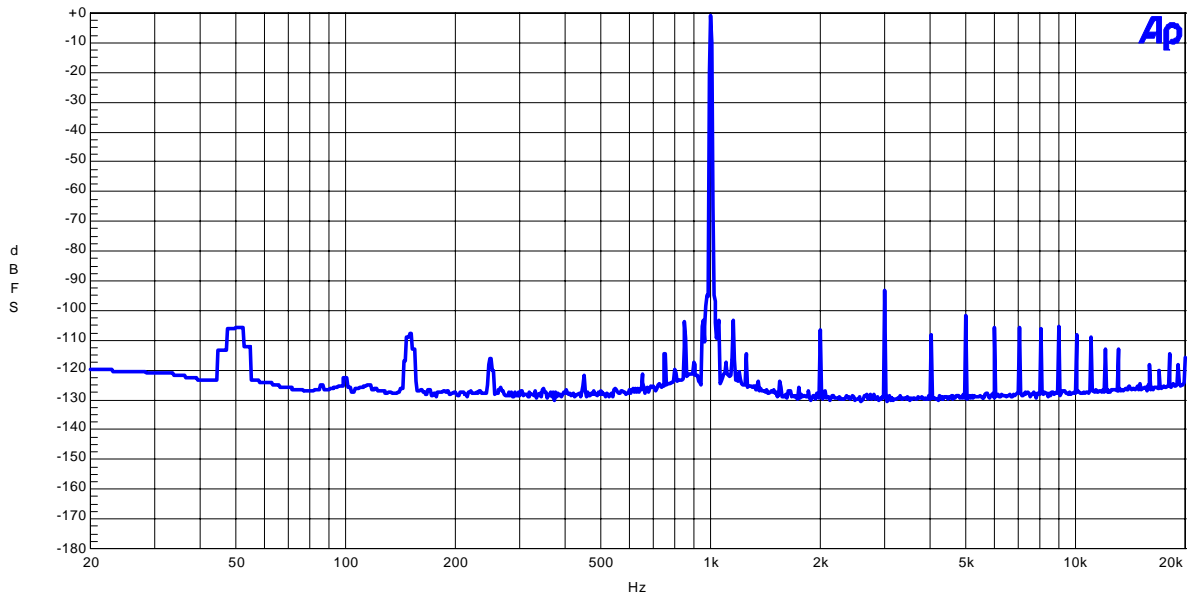

Figure 6. FFT Plot

AKM

AK4552 ADC FFT Plot
VA=VD=3.0V, fs=44.1kHz, Input=-60dB, fin=1kHz

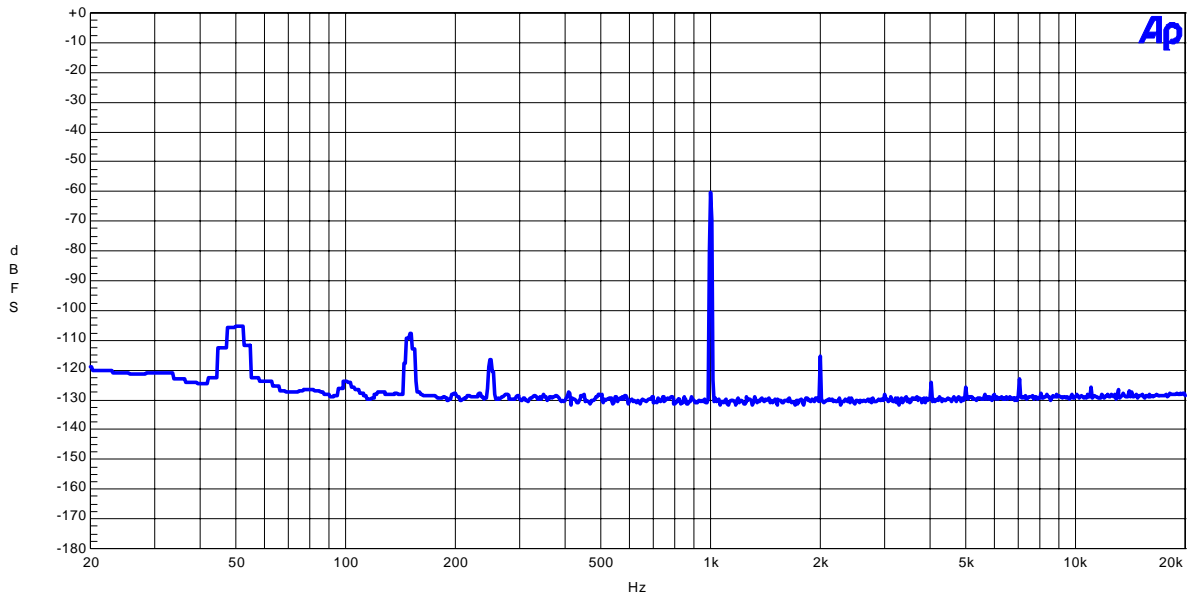

Figure 7. FFT Plot

AKM

AK4552 ADC FFT Plot
VA=VD=3.0V, fs=44.1kHz, fin=None

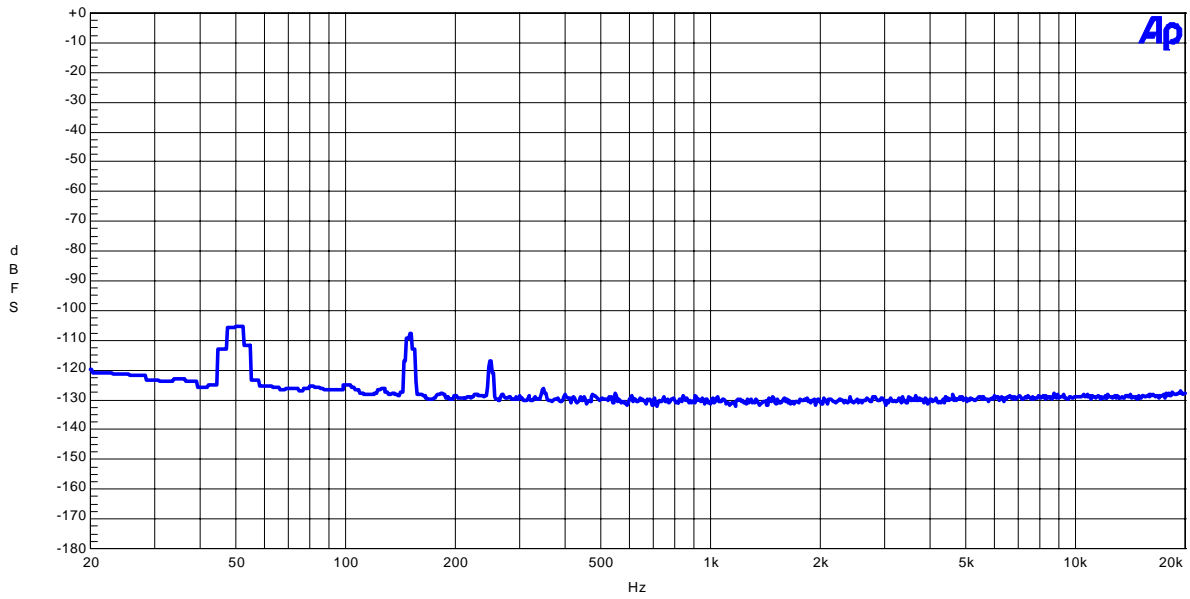

Figure 8. FFT Plot

2. DAC (Normal Speed)

AKM

AK4552 DAC THD+N vs. Input Level
VA=VD=3.0V, fs=44.1kHz, fin=1kHz

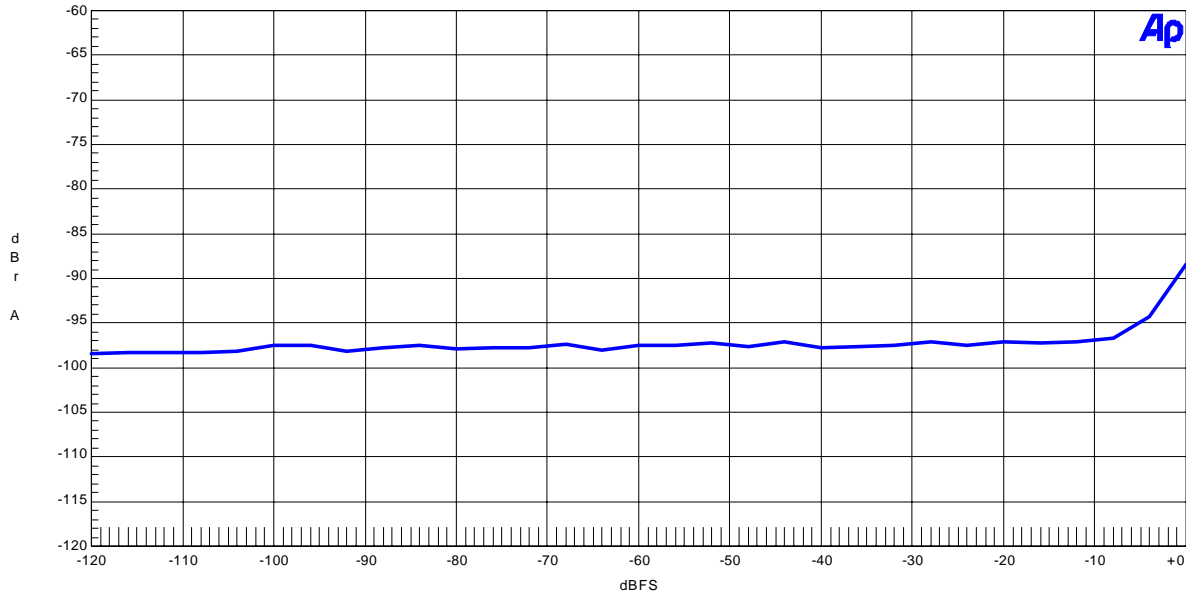

Figure 1. THD+N vs. Input Level

AKM

AK4552 DAC THD+N vs. Input Frequency
VA=VD=3.0V, fs=44.1kHz, Input=0dBFS

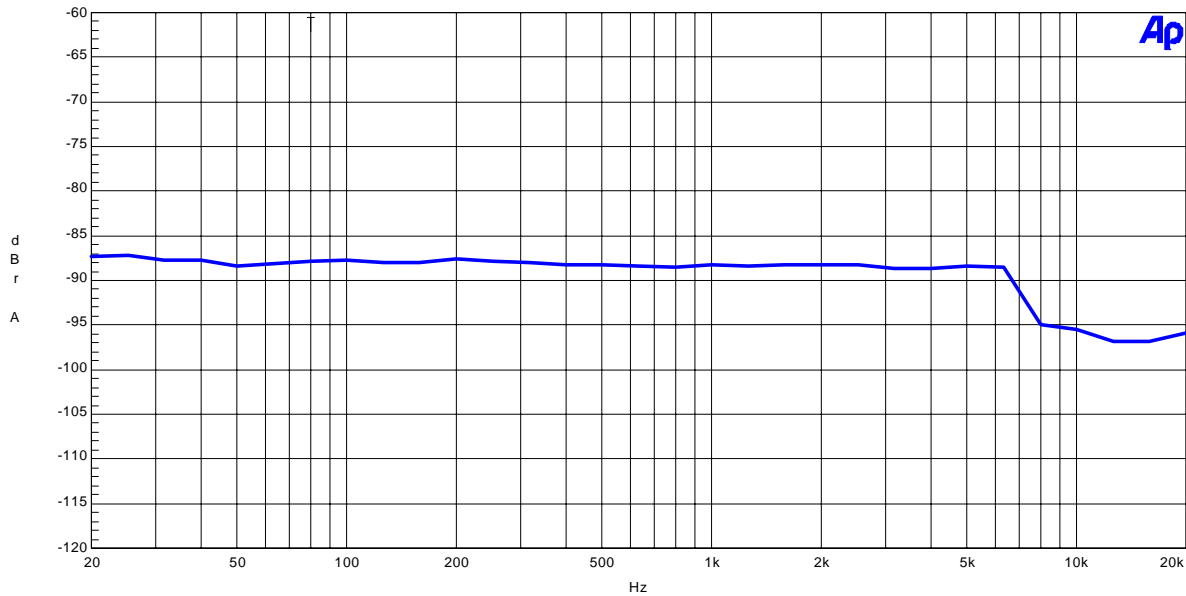

Figure 2. THD+N vs. Input Frequency

AKM

AK4552 DAC Linearity
VA=VD=3.0V, fs=44.1kHz, fin=1kHz

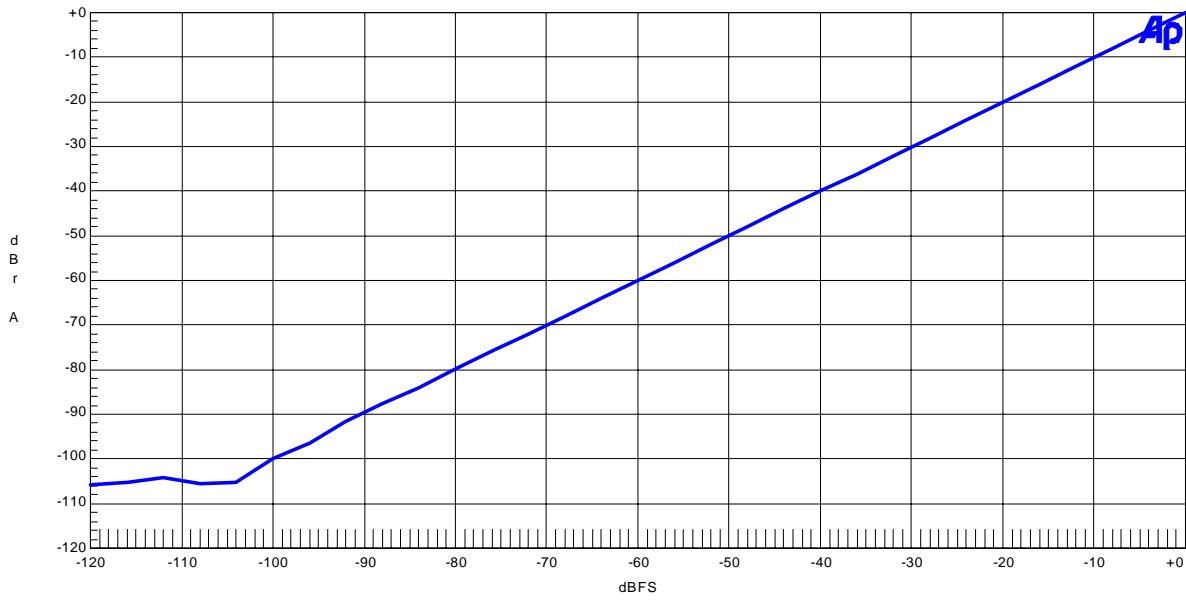

Figure 3. Linearity

AKM

AK4552 DAC Frequency Response
VA=VD=3.0V, fs=44.1kHz, Input=0dBFS

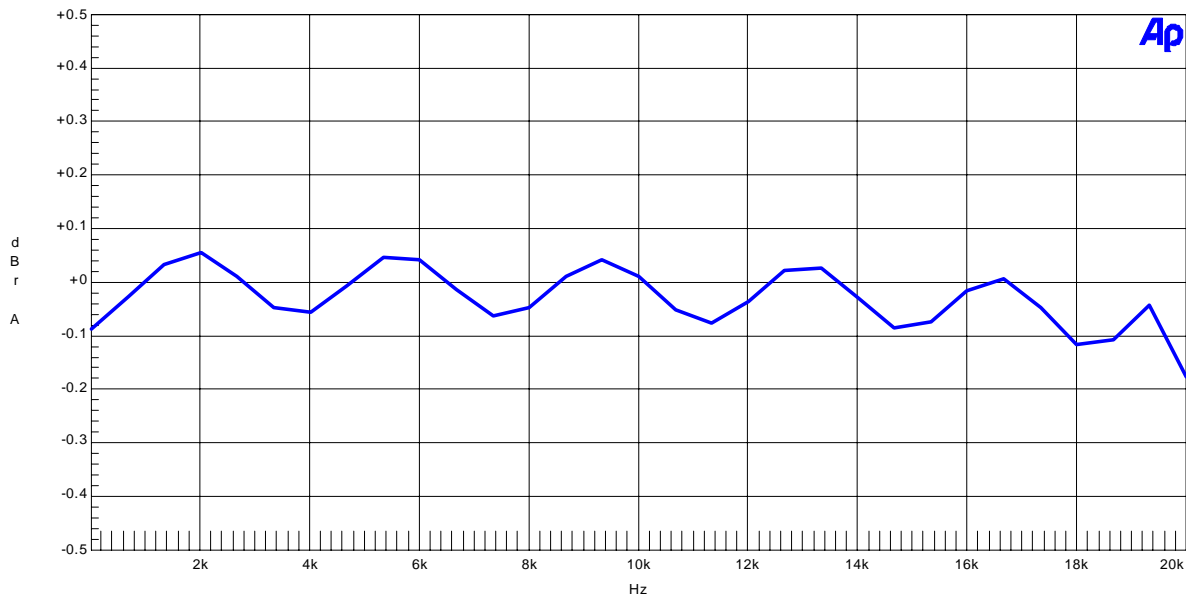

Figure 4. Frequency Response

AKM

AK4552 DAC Crosstalk
VA=VD=3.0V, fs=44.1kHz, Input=0dBFS

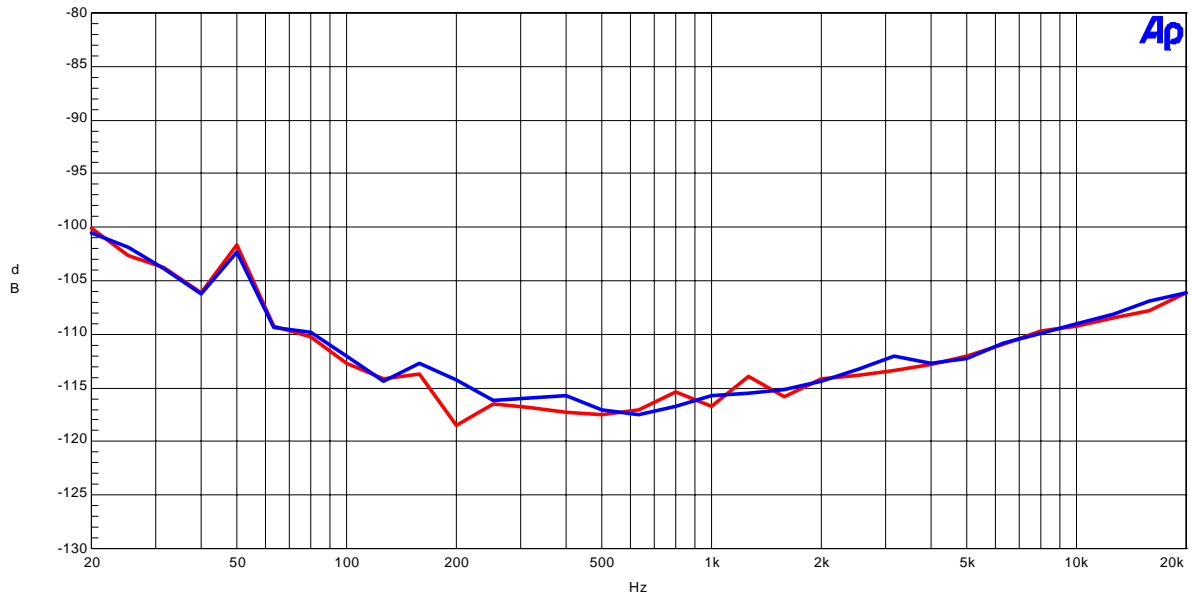

Figure 5. Crosstalk

AKM

AK4552 DAC FFT Plot
VA=VD=3.0V, fs=44.1kHz, Input=0dBFS, fin=1kHz

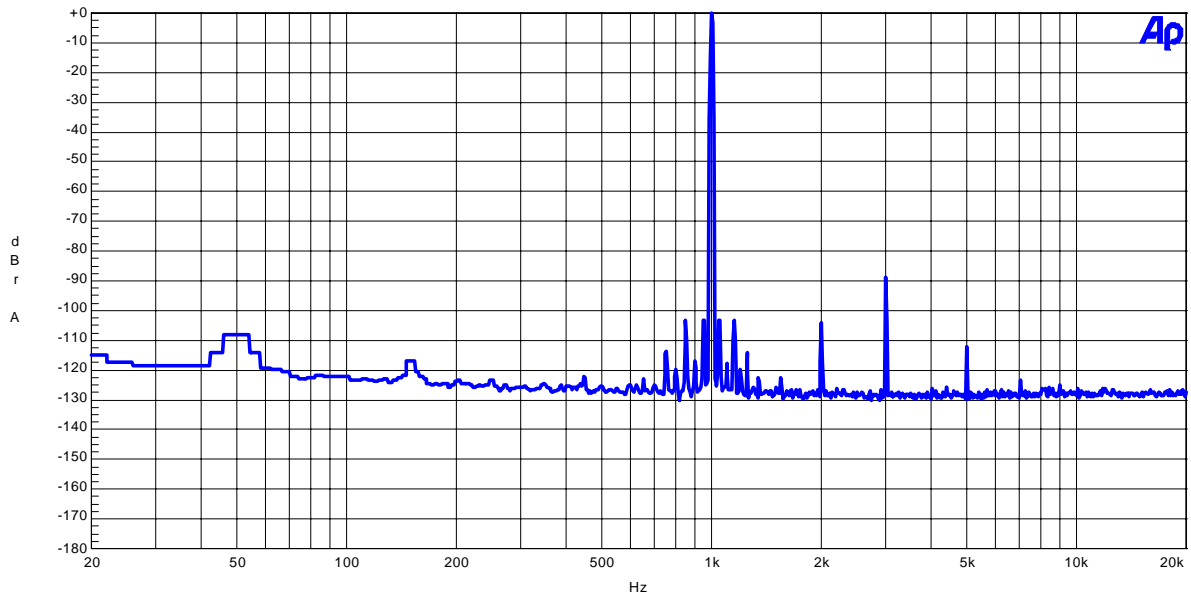

Figure 6. FFT Plot

AKM

AK4552 DAC FFT Plot
VA=VD=3.0V, fs=44.1kHz, Input=-60dBFS, fin=1kHz

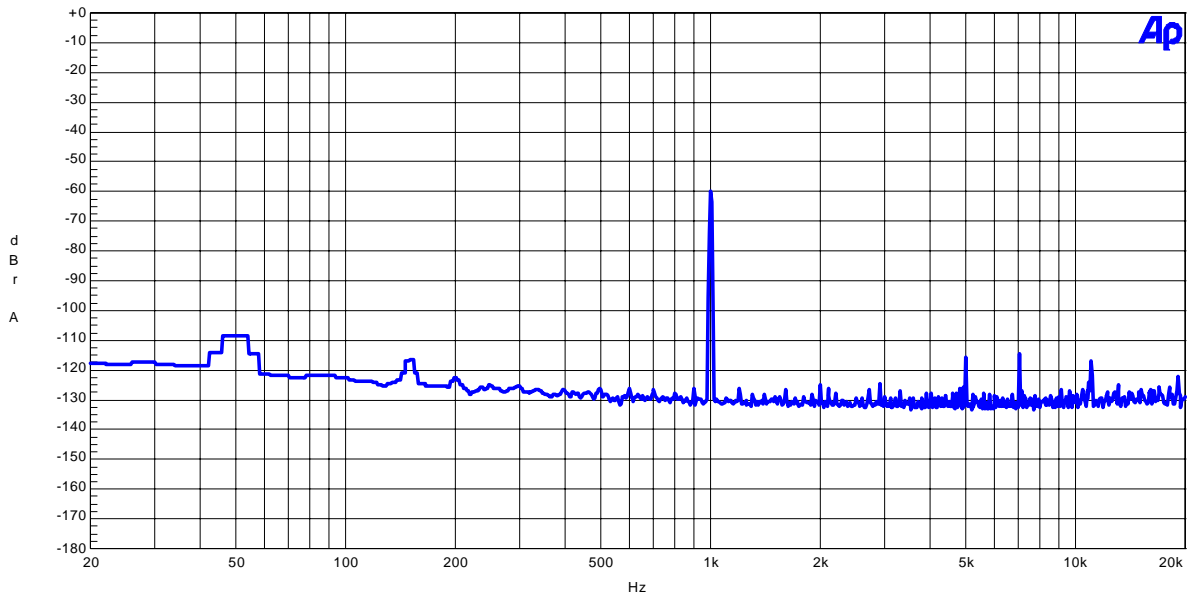

Figure 7. FFT Plot

AKM

AK4552 DAC FFT Plot
VA=VD=3.0V, fs=44.1kHz, fin=None

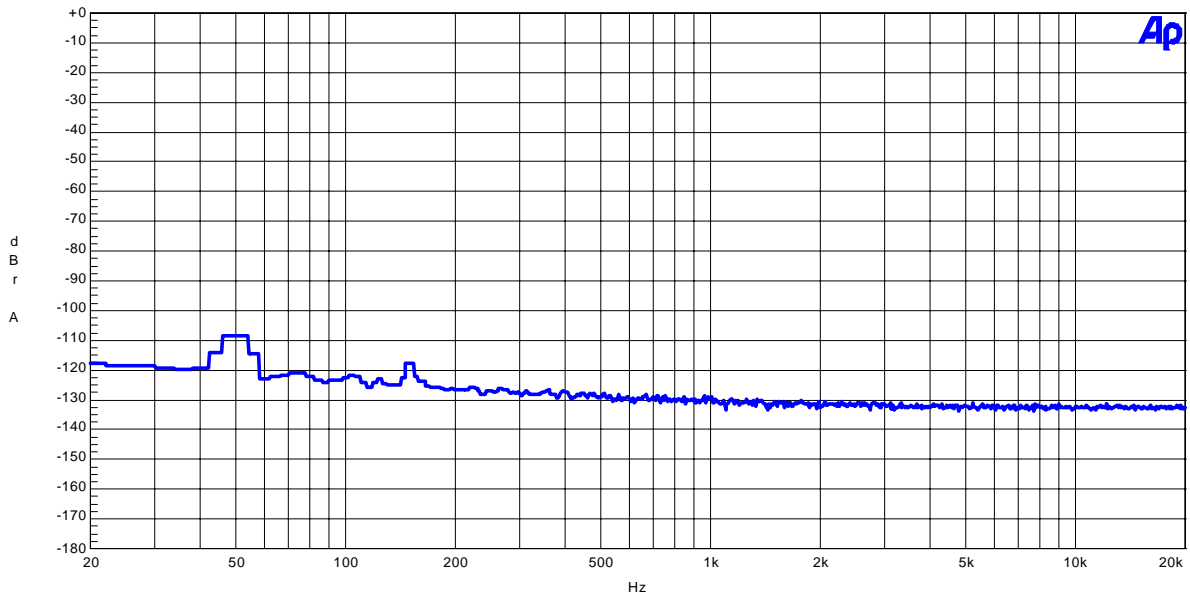

Figure 8. FFT Plot

3. ADC (Double Speed)

AKM

AK4552 ADC THD+N vs. Input Level
VA=VD=3.0V, fs=96kHz, fin=1kHz

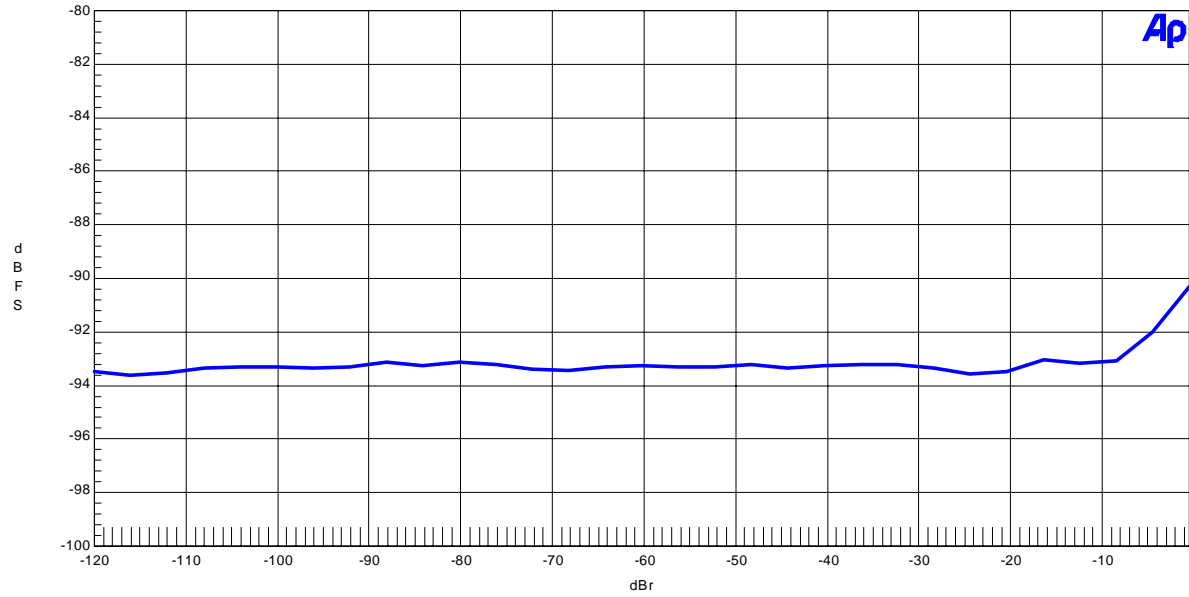

Figure 1. THD+N vs. Input Level

AKM

AK4552 ADC THD+N vs. Input Frequency
VA=VD=3.0V, fs=96kHz, Input=-0.5dBr

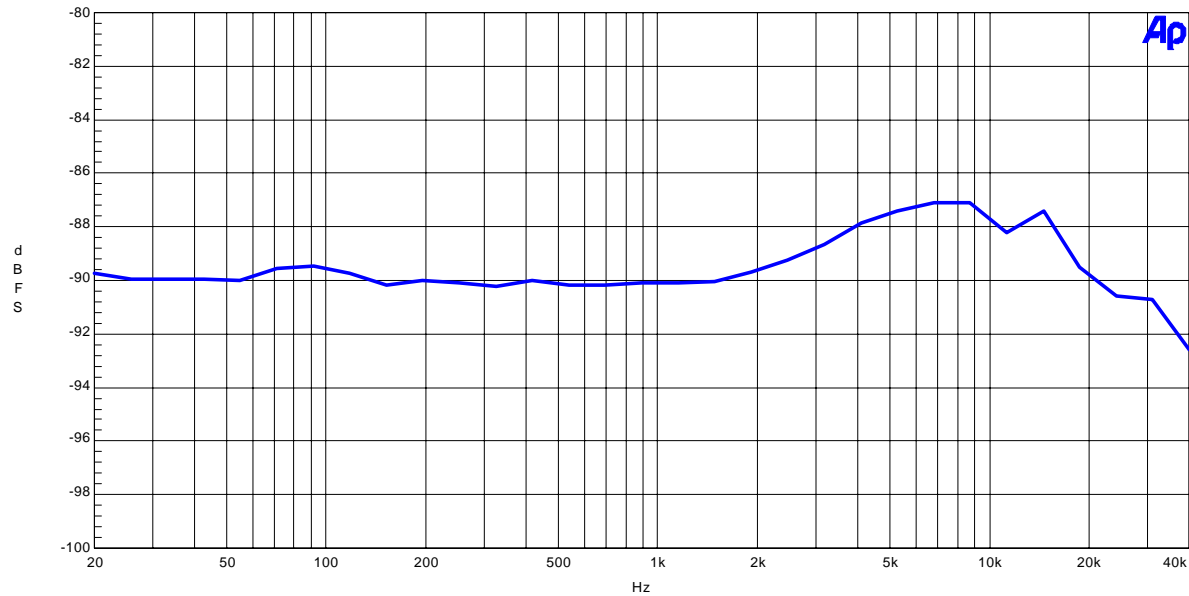

Figure 2. THD+N vs. Input Frequency

AKM

AK4552 ADC Linearity
VA=VD=3.0V, fs=96kHz, fin=1kHz

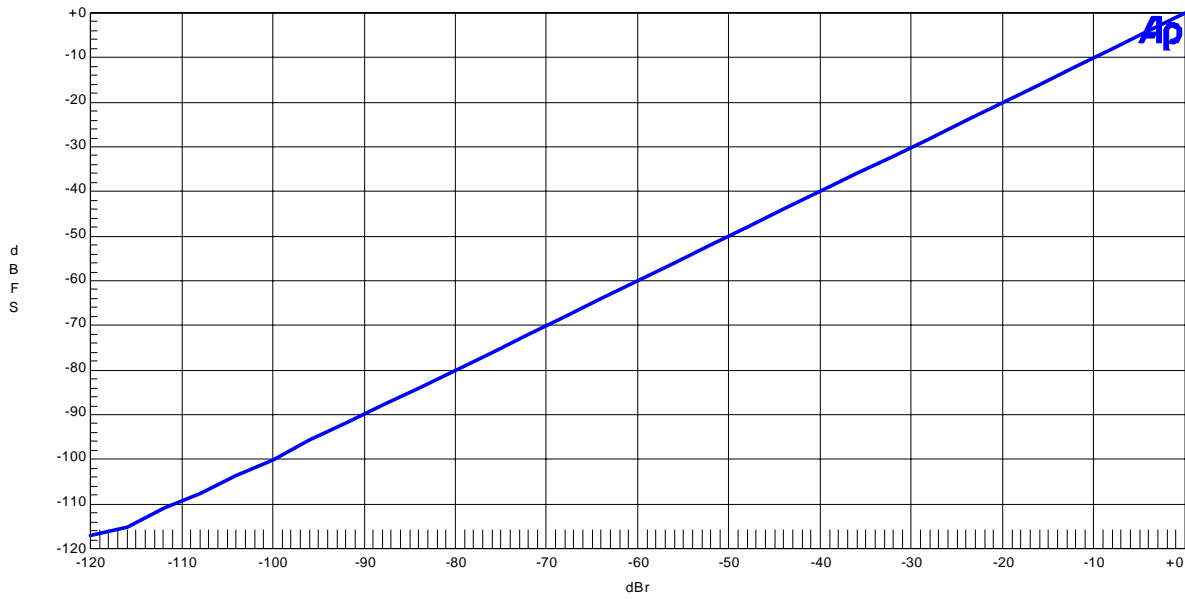

Figure 3. Linearity

AKM

AK4552 ADC Frequency Response
VA=VD=3.0V, fs=96kHz, Input=-0.5dBr

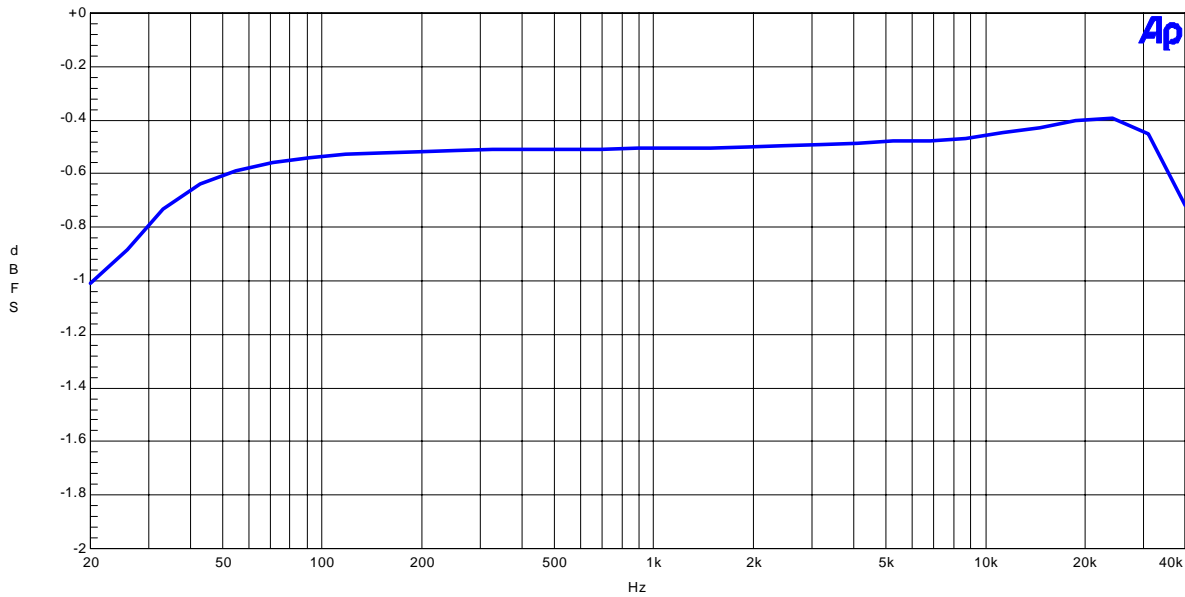

Figure 4. Frequency Response

AKM

AK4552 ADC Crosstalk
VA=VD=3.0V, fs=96kHz, Input=-0.5dBr

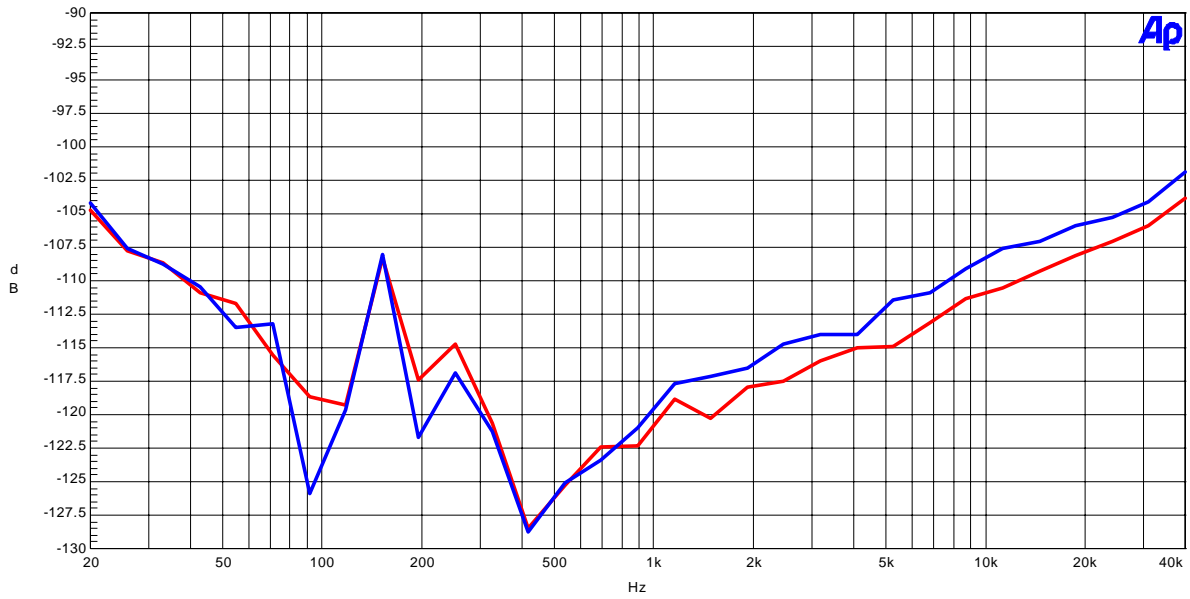

Figure 5. Crosstalk

AKM

AK4552 ADC FFT Plot
VA=VD=3.0V, fs=96kHz, Input=-0.5dBr, fin=1kHz

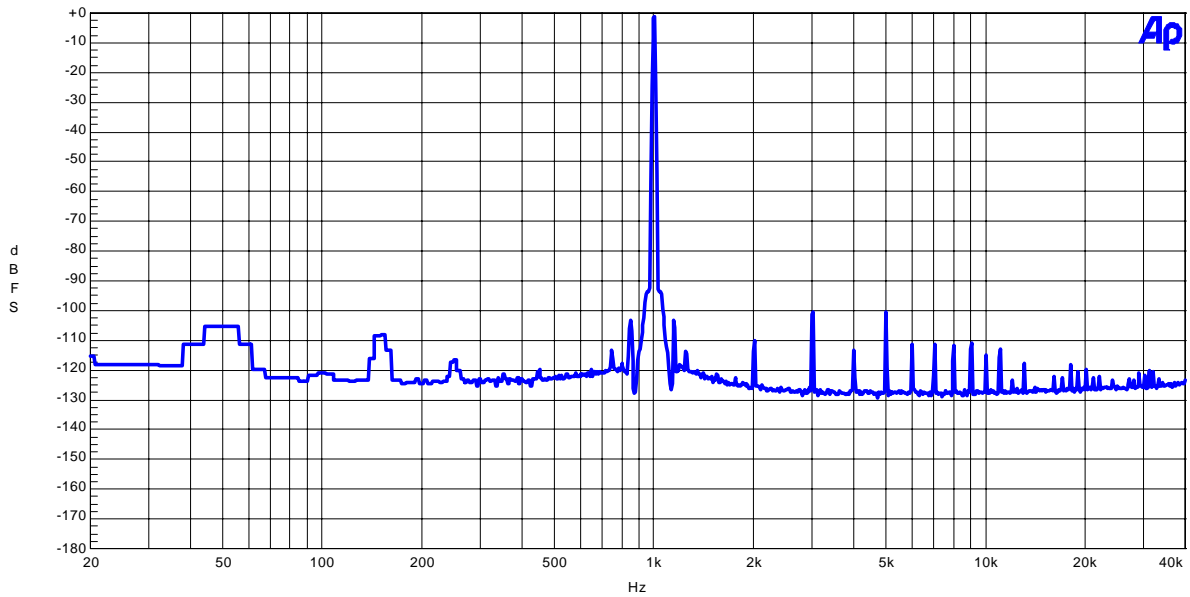

Figure 6. FFT Plot

AKM

AK4552 ADC FFT Plot
VA=VD=3.0V, fs=96kHz, Input=-60dB, fin=1kHz

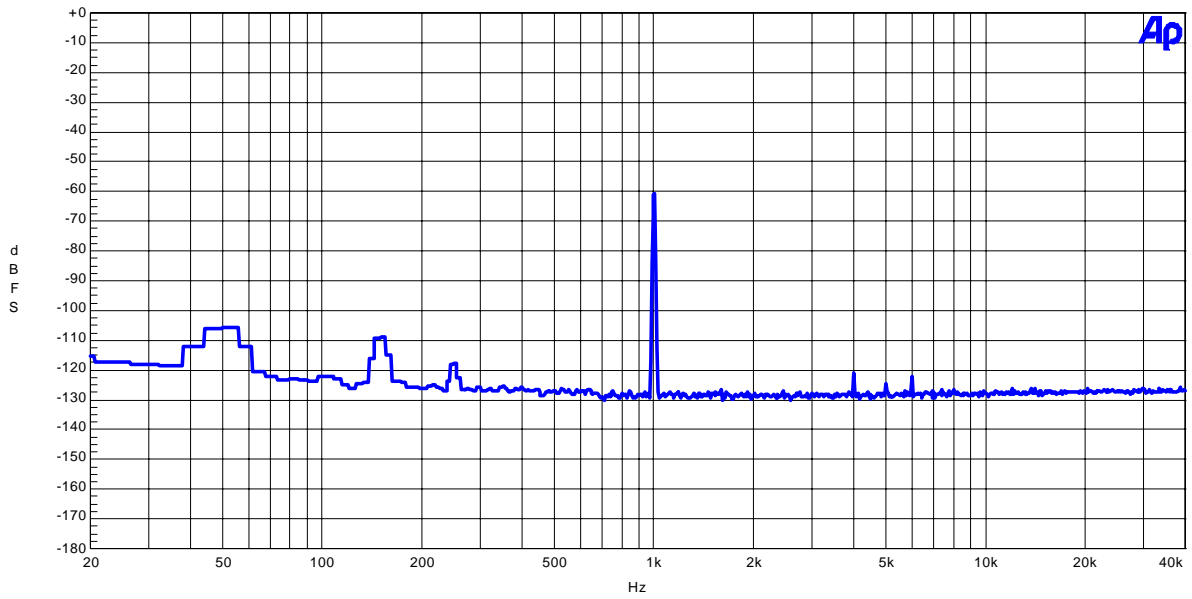

Figure 7. FFT Plot

AKM

AK4552 ADC FFT Plot
VA=VD=3.0V, fs=96kHz, fin=None

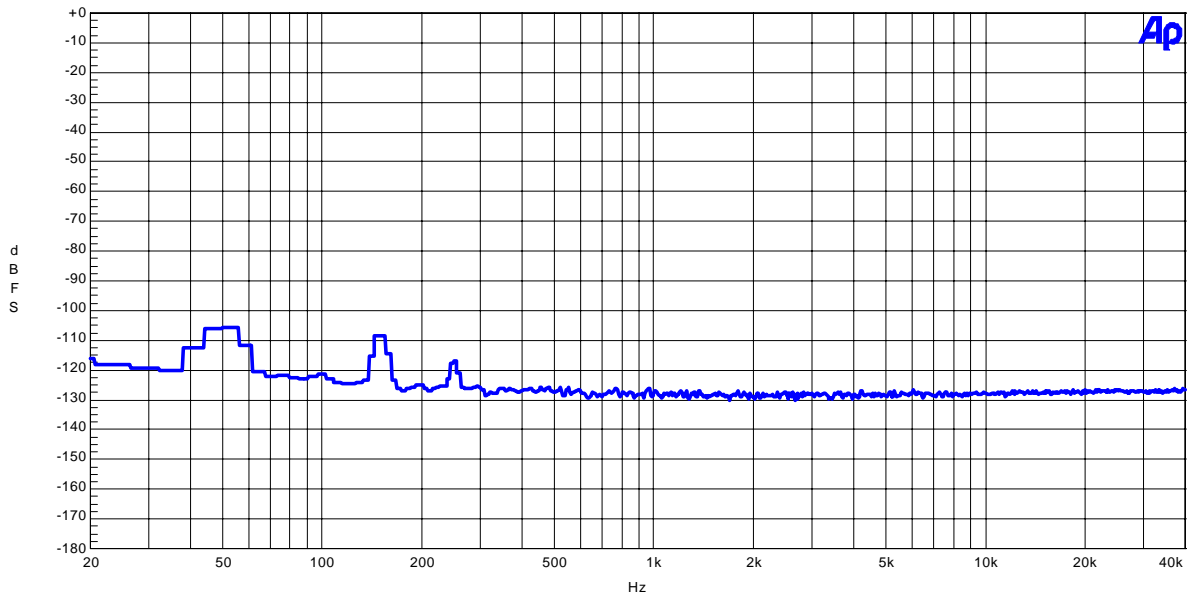

Figure 8. FFT Plot

4. DAC (Double Speed)

AKM

AK4552 DAC THD+N vs. Input Level
 VA=VD=3.0V, fs=96kHz, fin=1kHz

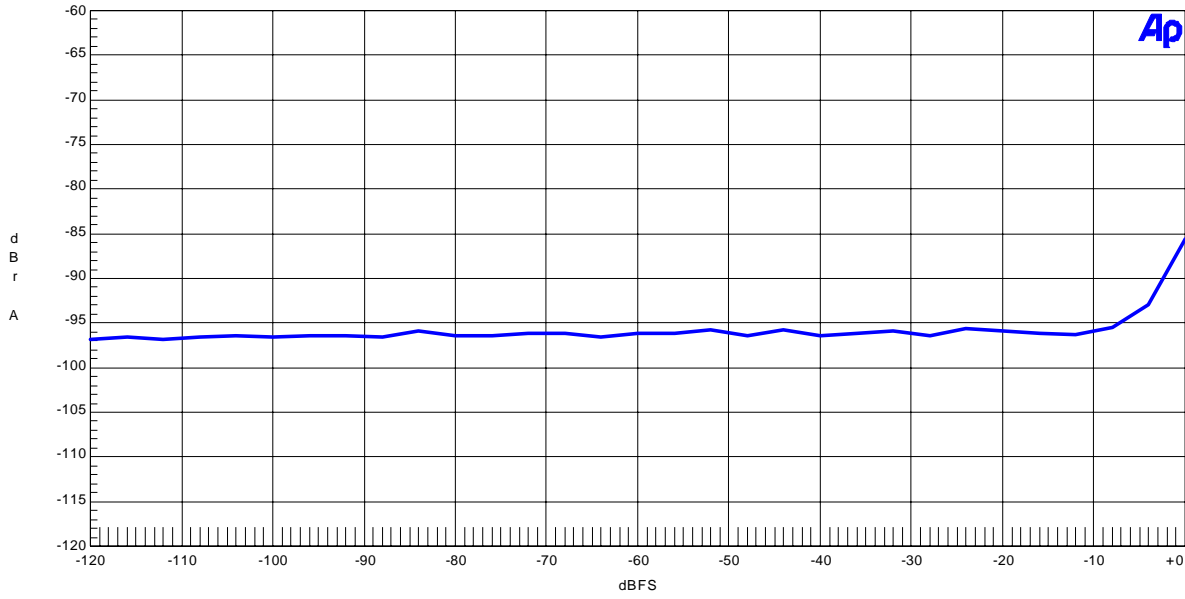

Figure 1. THD+N vs. Input Level

AKM

AK4552 DAC THD+N vs. Input Frequency
 VA=VD=3.0V, fs=96kHz, Input=0dBFS

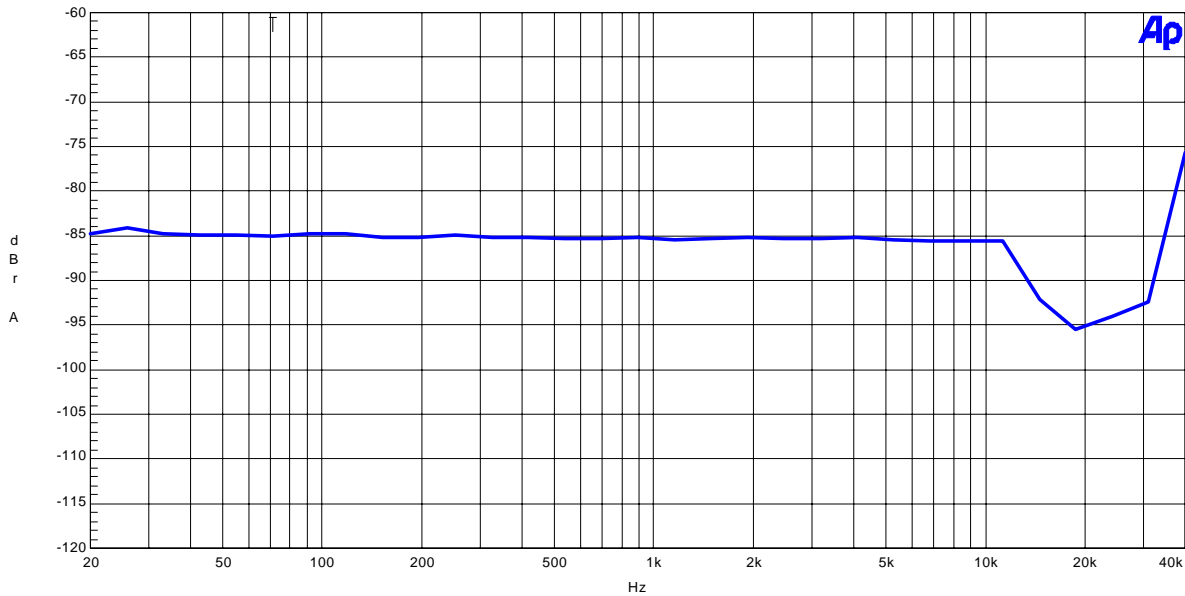

Figure 2. THD+N vs. Input Frequency

AKM

AK4552 DAC Linearity
VA=VD=3.0V, fs=96kHz, fin=1kHz

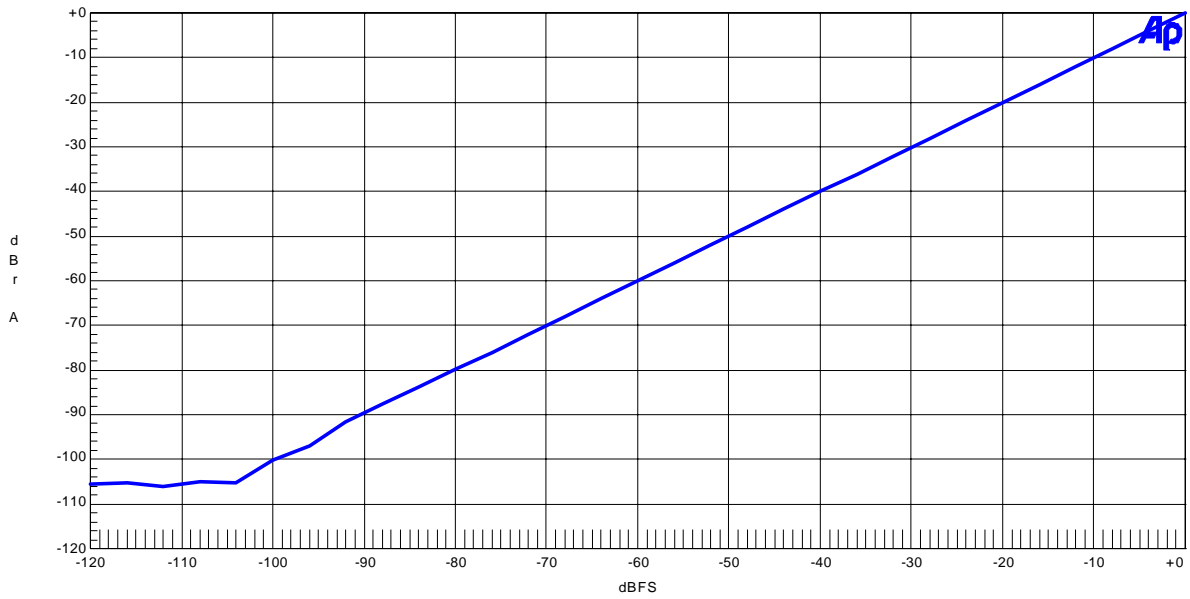

Figure 3. Linearity

AKM

AK4552 DAC Frequency Response
VA=VD=3.0V, fs=96kHz, Input=0dBFS

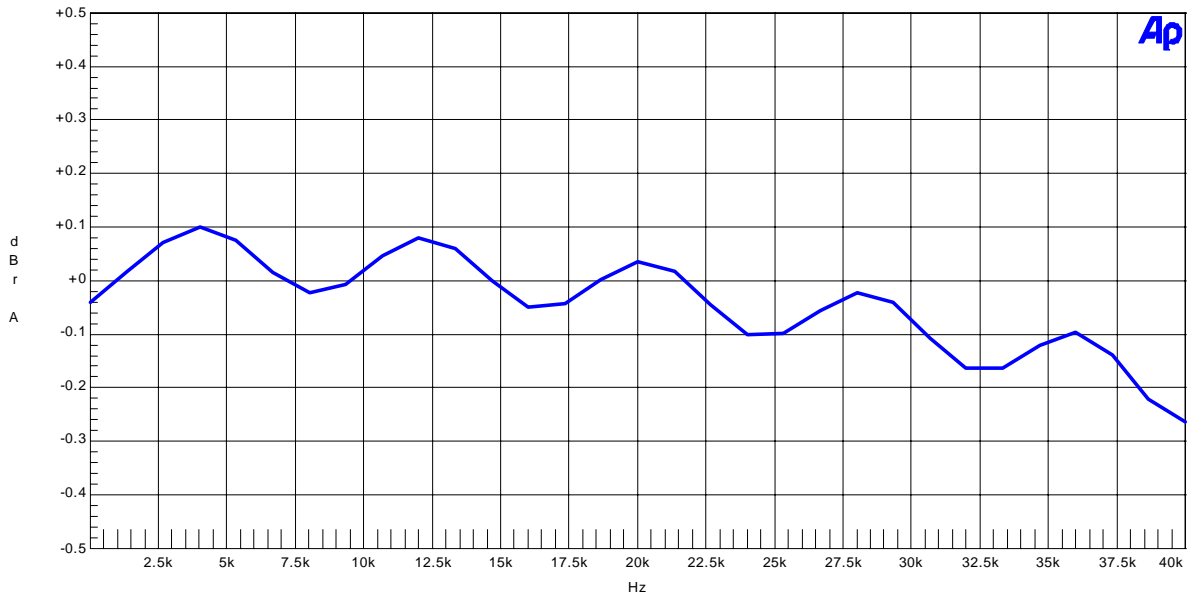

Figure 4. Frequency Response

AKM

AK4552 DAC Crosstalk
VA=VD=3.0V, fs=96kHz, Input=0dBFS

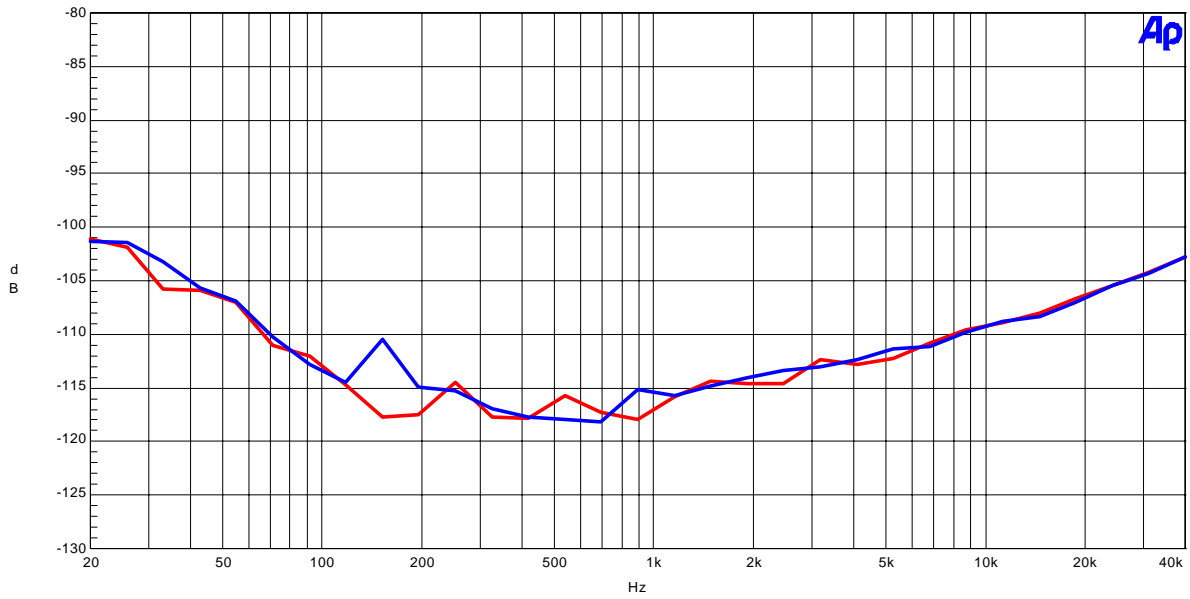

Figure 5. Crosstalk

AKM

AK4552 DAC FFT Plot
VA=VD=3.0V, fs=96kHz, Input=0dBFS, fin=1kHz

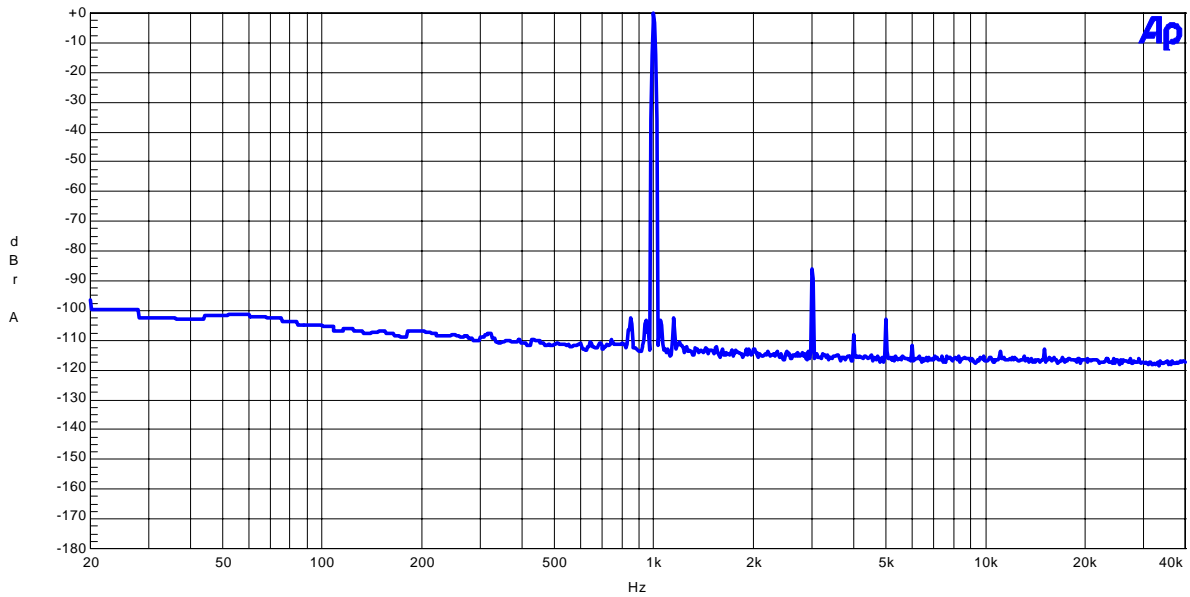

Figure 6. FFT Plot

AKM

AK4552 DAC FFT Plot
VA=VD=3.0V, fs=96kHz, Input=-60dBFS, fin=1kHz

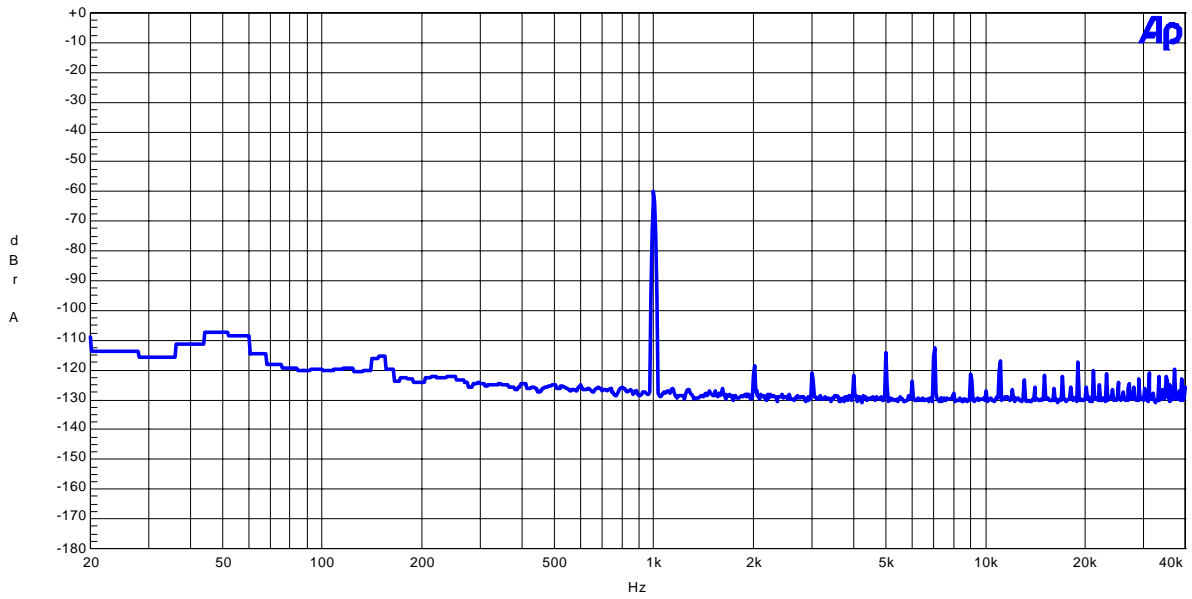

Figure 7. FFT Plot

AKM

AK4552 DAC FFT Plot
VA=VD=3.0V, fs=96kHz, fin=None

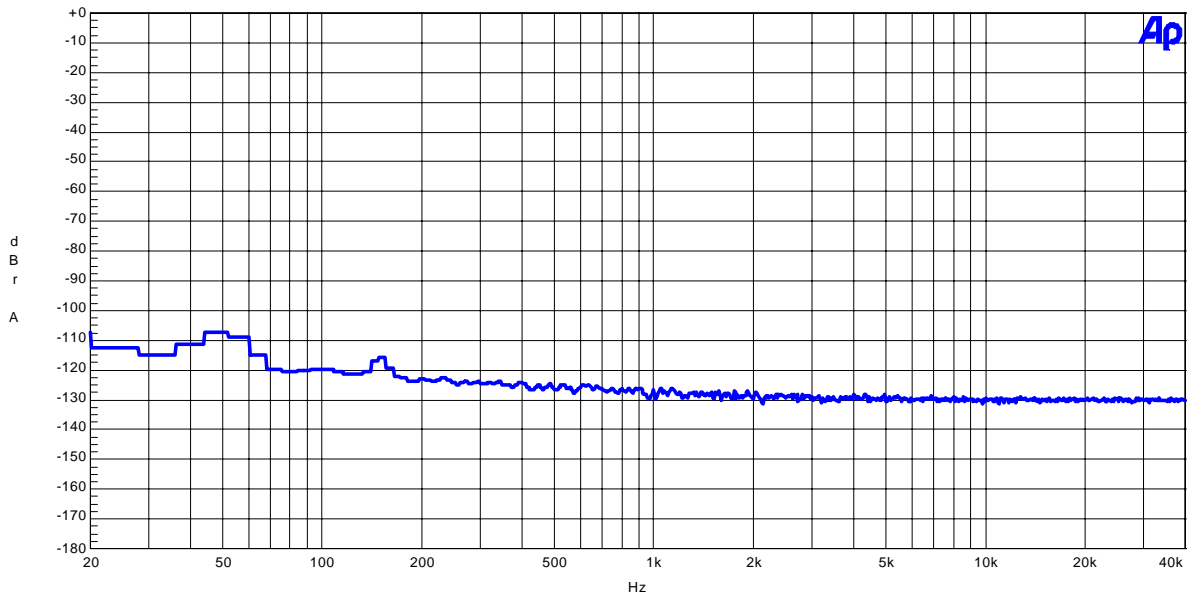

Figure 8. FFT Plot

Revision History

Date	Manual Revision	Board Revision	Reason	Contents
05/10/18	KM080600	0	First Edition	

IMPORTANT NOTICE

- These products and their specifications are subject to change without notice. Before considering any use or application, consult the Asahi Kasei Microsystems Co., Ltd. (AKM) sales office or authorized distributor concerning their current status.
- AKM assumes no liability for infringement of any patent, intellectual property, or other right in the application or use of any information contained herein.
- Any export of these products, or devices or systems containing them, may require an export license or other official approval under the law and regulations of the country of export pertaining to customs and tariffs, currency exchange, or strategic materials.
- AKM products are neither intended nor authorized for use as critical components in any safety, life support, or other hazard related device or system, and AKM assumes no responsibility relating to any such use, except with the express written consent of the Representative Director of AKM. As used here:
 - (a) A hazard related device or system is one designed or intended for life support or maintenance of safety or for applications in medicine, aerospace, nuclear energy, or other fields, in which its failure to function or perform may reasonably be expected to result in loss of life or in significant injury or damage to person or property.
 - (b) A critical component is one whose failure to function or perform may reasonably be expected to result, whether directly or indirectly, in the loss of the safety or effectiveness of the device or system containing it, and which must therefore meet very high standards of performance and reliability.
- It is the responsibility of the buyer or distributor of an AKM product who distributes, disposes of, or otherwise places the product with a third party to notify that party in advance of the above content and conditions, and the buyer or distributor agrees to assume any and all responsibility and liability for and hold AKM harmless from any and all claims arising from the use of said product in the absence of such notification.

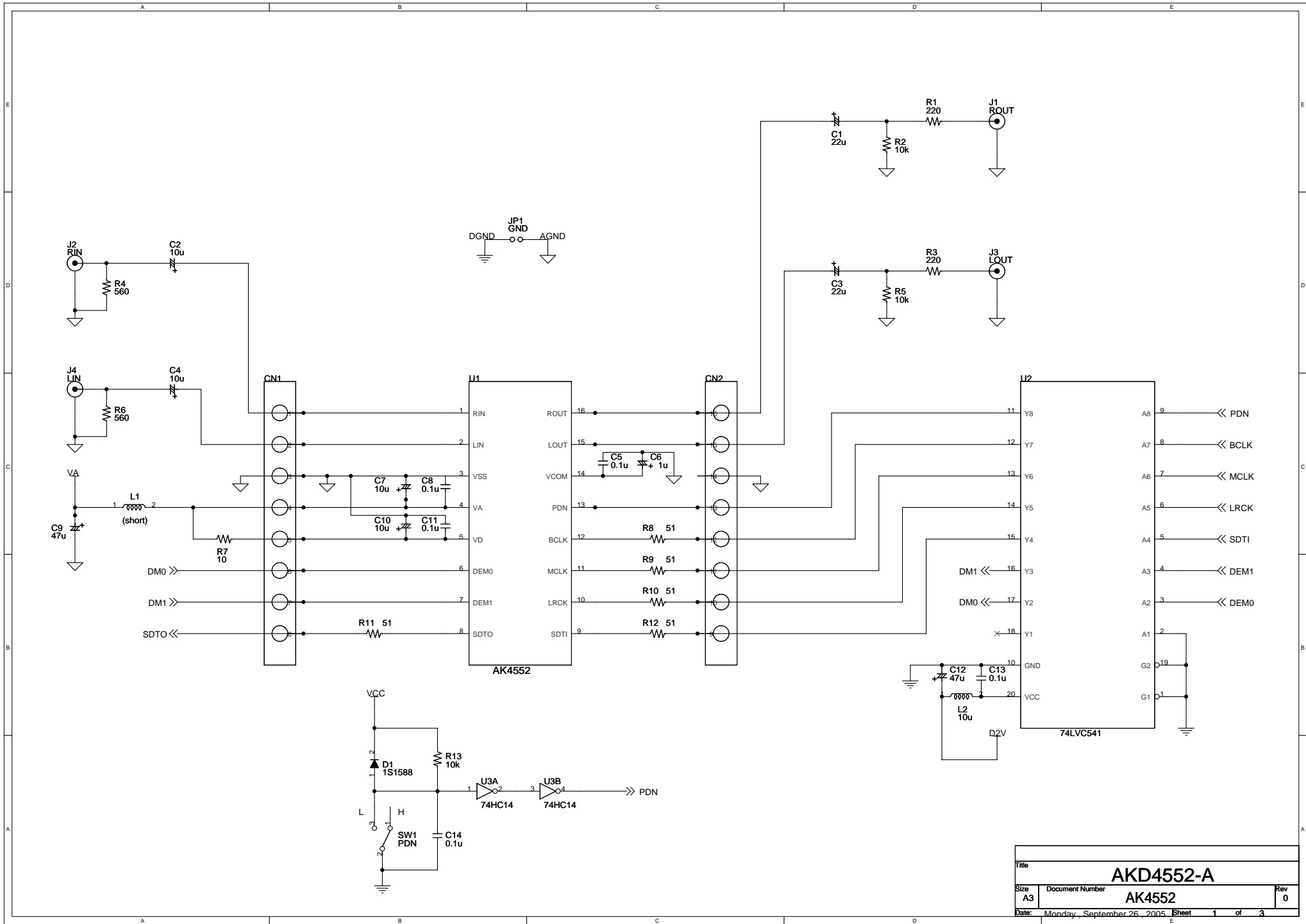

Title			AKD4552-A		
Size	Document Number	AK4552			Rev
A3					0
Date:	Monday, September 26, 2005	Sheet	1	of	3

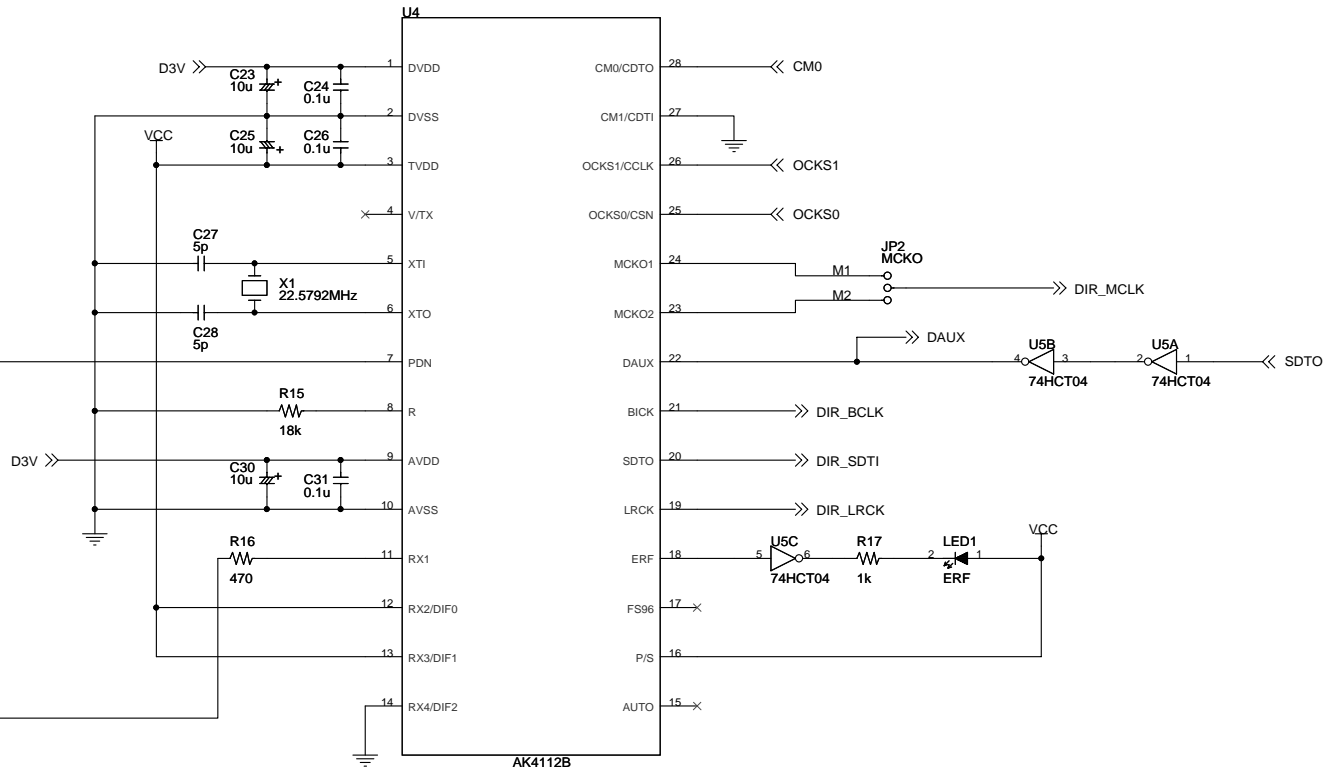
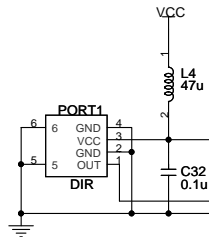
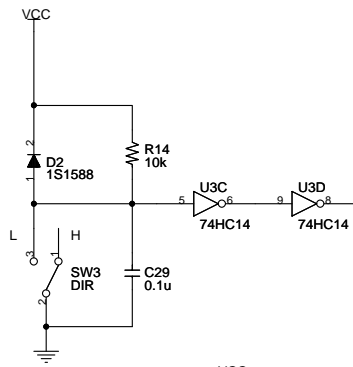
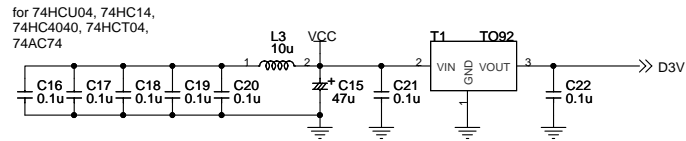
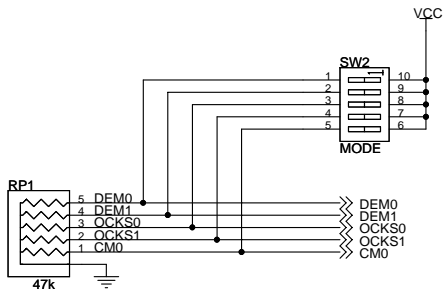

Title		
AKD4552-A		
Size	Document Number	Rev
A3	DIR	0
Date: Monday, September 26, 2005 Sheet 2 of 3		

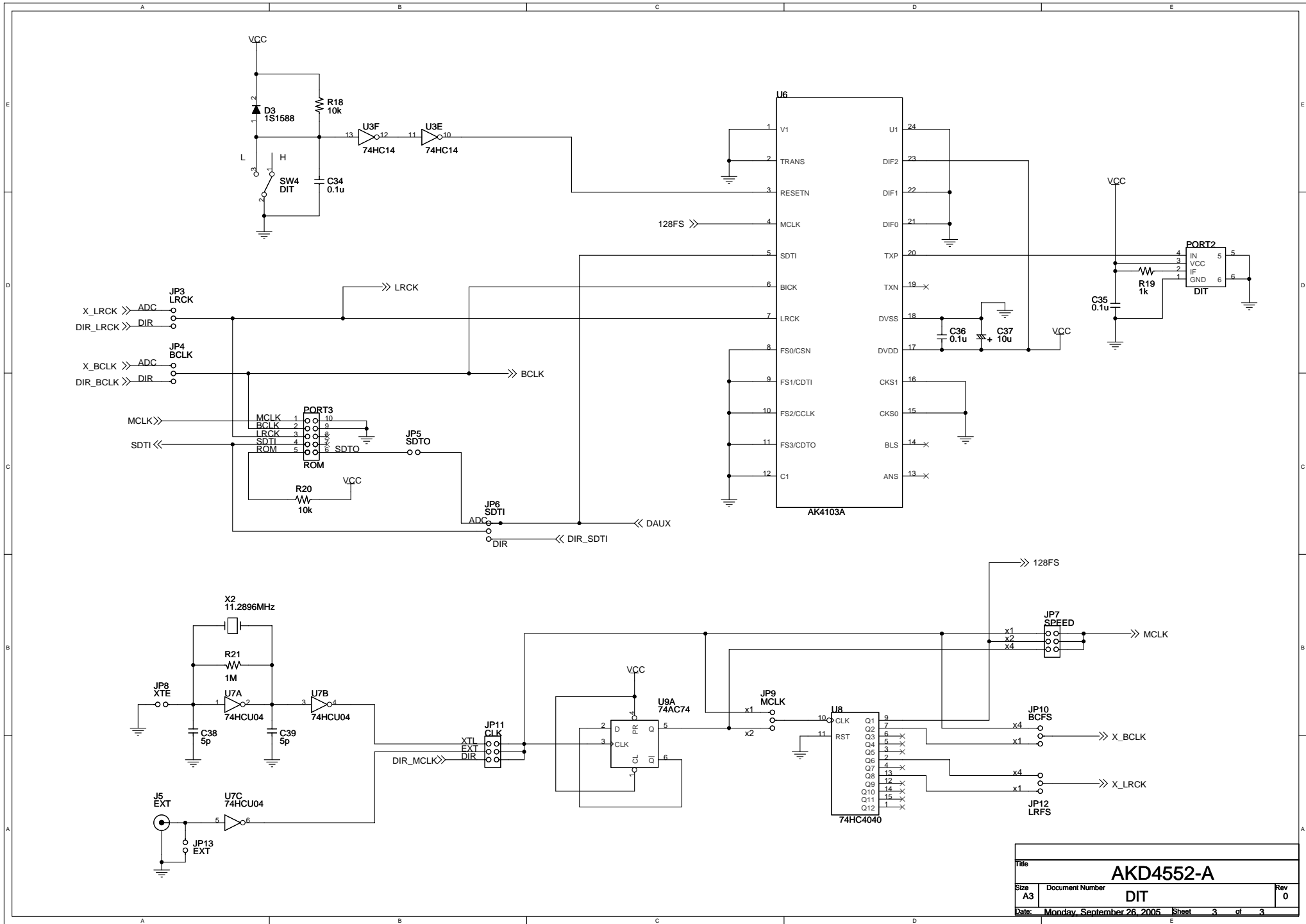

Title			AKD4552-A		
Size	Document Number	DIT			Rev
A3					0
Date:	Monday, September 26, 2005	Sheet	3	of	3

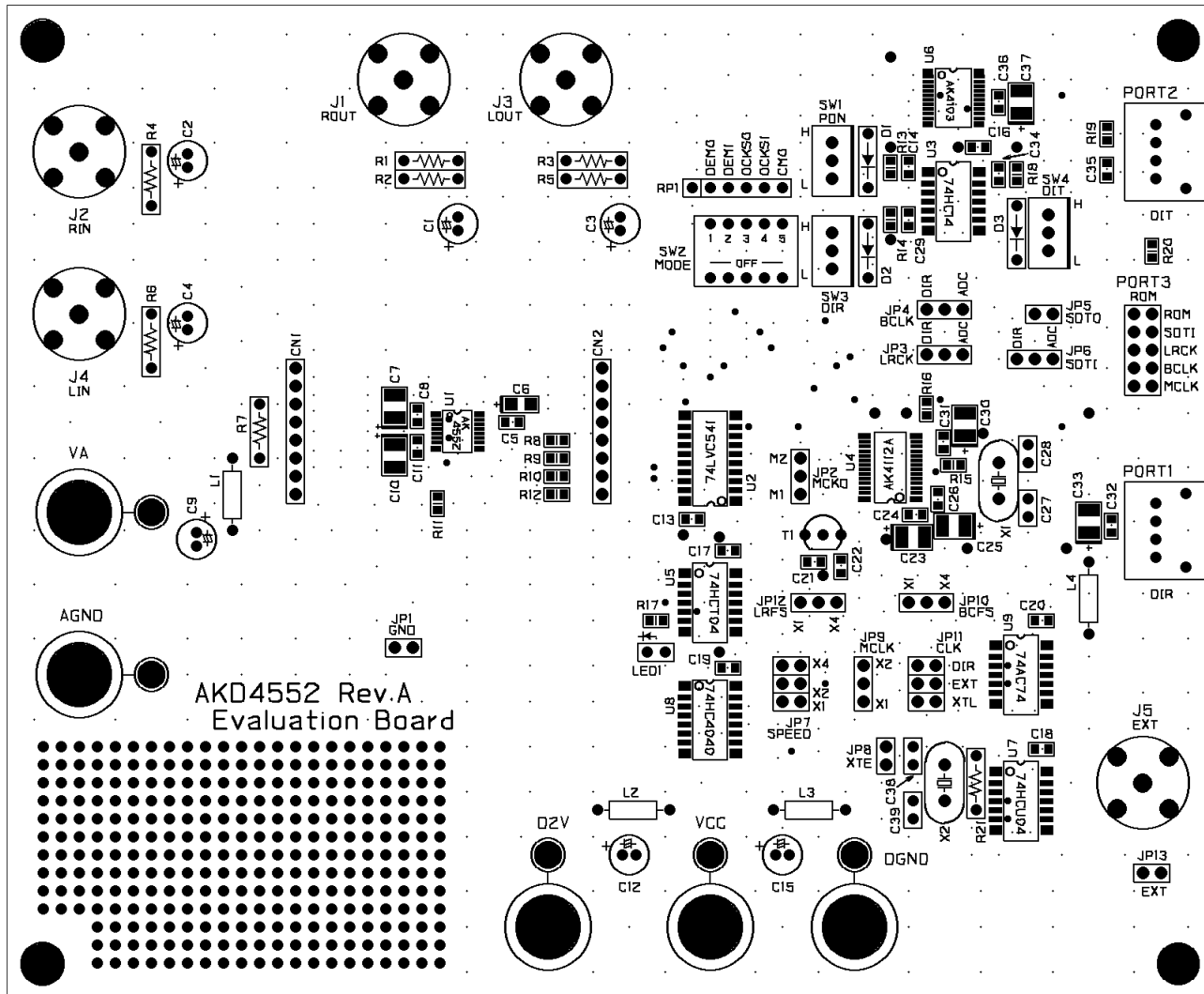

AKD4552 Rev.A
Evaluation Board

AKD4552 Rev.A L1 SR SILK

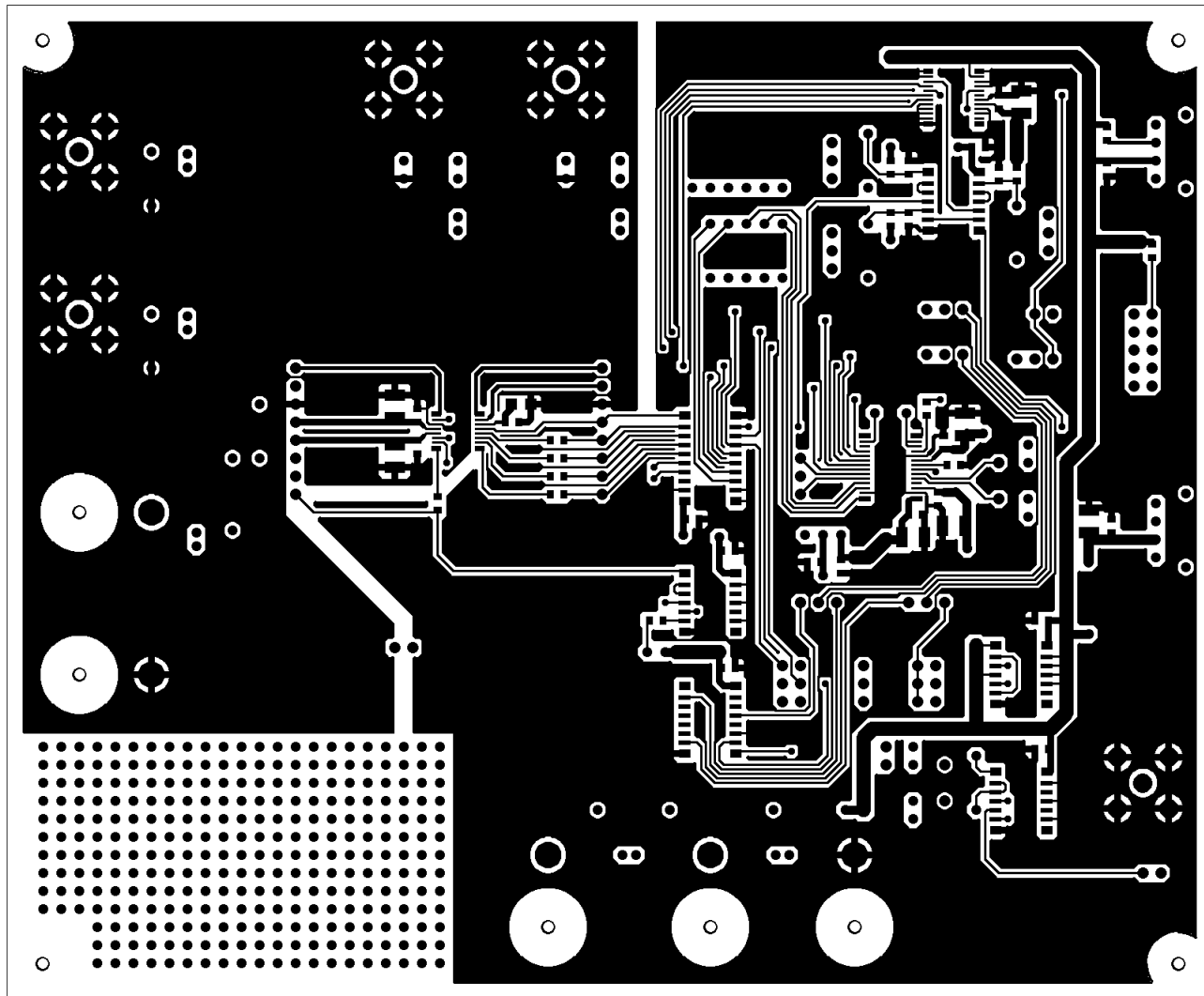

AKD4552 Rev.A L1

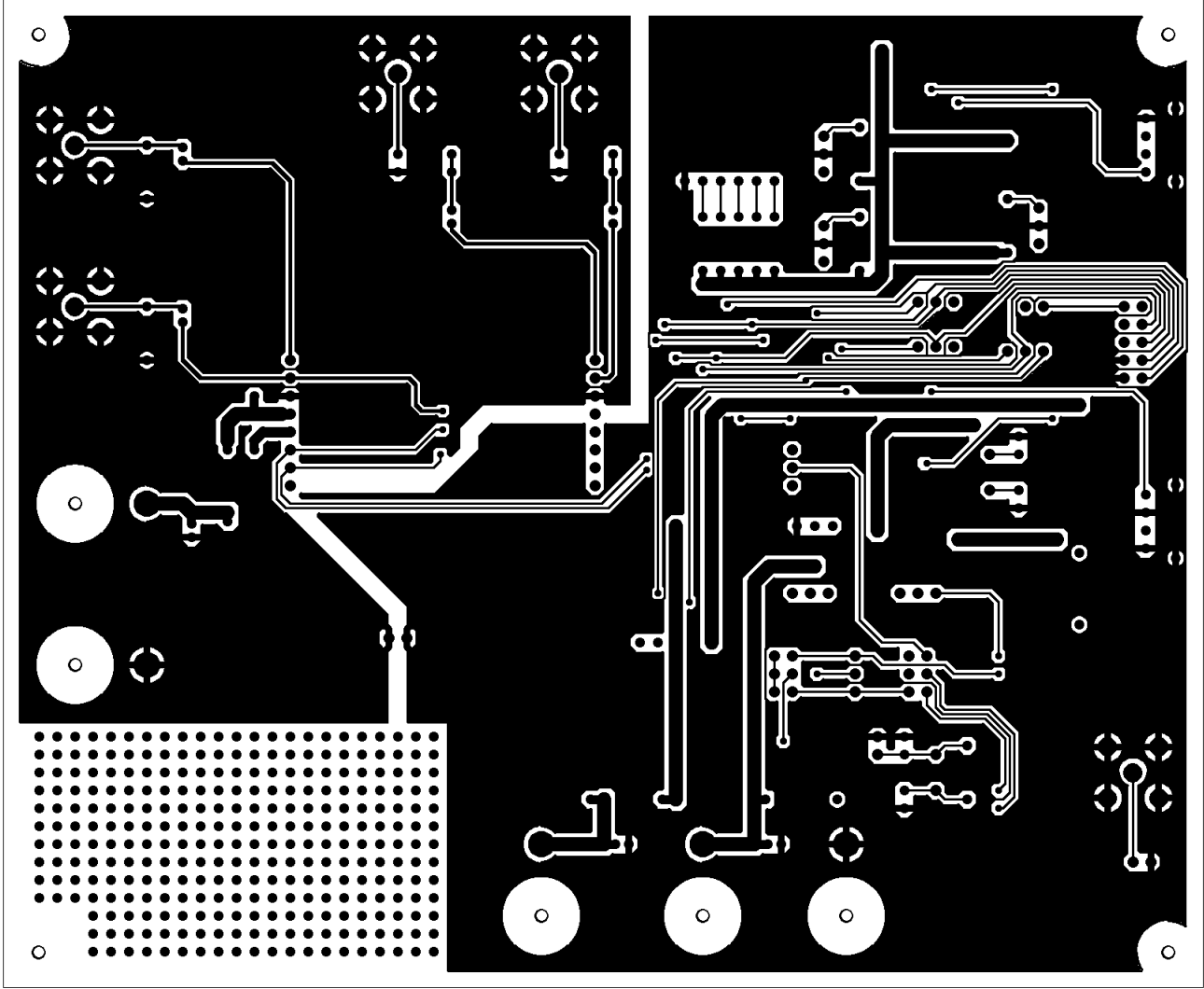

AKD4525 Rev.A LS