

# ULTRA MINIATURE RELAY SIGNAL RELAY

## FTR-C1 Series

RoHS compliant

### ■ FEATURES

- Dimensions of large contact gap relay  
 Height: 9.3 mm maximum (THT)  
           9.65 mm maximum (SMT)  
 Length: 15 mm maximum  
 Width: 7.5 mm maximum
- Conforms to IEC60950 / EN60950 / UL1950/ C22.2  
 No.950 spacing & high breakdown voltage  
     Clearance: 2.0 mm ( coil and contacts)  
     Creepage: 2.5 mm ( coil and contacts)
- HIGH RELIABILITY  
 Bifurcated contacts
- Low power consumption 280 mW (latching type  
 140mW)
- RoHS Compliant since beginning of production

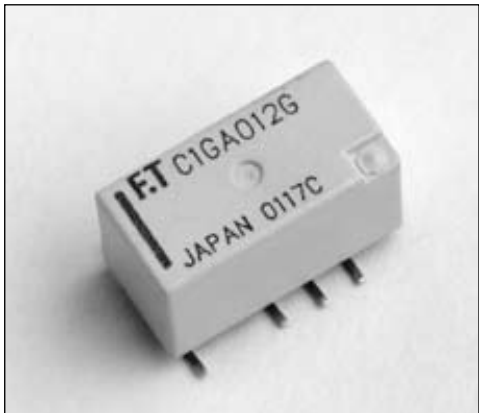

### ■ ORDERING INFORMATION

[Example]      FTR-C1    C    A    012    G-(B05)\*  
                     (a)        (b) (c)    (d)    (e) (f)

(a)	Series Name	FTR-C1
(b)	Terminal Appearance	C: Through hole type G: Surface mount type
(c)	Operation Function	A: Standard Type B: Single coil latching type
(d)	Coil Number	Nominal Voltage
(e)	Contact Material	G: Silver alloy

**Remarks: Actual marking on relay would not carry code FTR and be as below:**

**Ordering code                      Actual marking**  
**FTR-C1CA03G                      →                      C1CA03G**

\* If ordering tape and reel package, please add "B05" after the partnumber (tape and reel is only available for SMT type, example: FTR-C1GA003G-B05)

# FTR-C1 Series

## ■ COIL DATA CHART

Standard type

Model		Nominal Voltage	Coil Resistance (±10%)	Must Operate Voltage	Must Release Voltage	Nominal Operating Power (±10%)
THT	SMT					
FTR-C1CA003G	FTR-C1GA003G	3 VDC	32.1Ω	2.25 VDC	0.3 VDC	280 mW
FTR-C1CA4.5G	FTR-C1GA4.5G	4.5 VDC	72.3 Ω	3.38 VDC	0.45 VDC	280 mW
FTR-C1CA005G	FTR-C1GA005G	5 VDC	89.3 Ω	3.75 VDC	0.5 VDC	280 mW
FTR-C1CA012G	FTR-C1GA012G	12VDC	514 Ω	9.00 VDC	1.2 VDC	280 mW
FTR-C1CA024G	FTR-C1GA024G	24VDC	1920 Ω	18.0 VDC	2.4 VDC	300 mW

Note: All values in the table are measured at 20°C.

Single coil latching type

Model		Nominal Voltage	Coil Resistance (±10%)	Set Voltage	Reset Voltage	Nominal Operating Power (±10%)
THT	SMT					
FTR-C1CB003G	FTR-C1GB003G	3 VDC	64 Ω	2.25 VDC	2.25 VDC	140 mW
FTR-C1CB4.5G	FTR-C1GB4.5G	4.5 VDC	145Ω	3.38 VDC	3.38 VDC	140 mW
FTR-C1CB005G	FTR-C1GB005G	5 VDC	179Ω	3.75 VDC	3.75 VDC	140 mW
FTR-C1CB012G	FTR-C1GB012G	12VDC	1029Ω	9.00 VDC	9.00 VDC	140 mW
FTR-C1CB024G	FTR-C1GB024G	24VDC	3200Ω	18.0 VDC	18.0 VDC	180 mW

Note: - All values in the table are measured at 20°C.  
 - Single coil latching type is applying to the standard now.

# FTR-C1 Series

## ■ SPECIFICATIONS

Item		FTR-C1CA ( )G FTR-C1GA ( )G	
Contact	Arrangement	2 Form C	
	Material	Silver alloy	
	Resistance (initial)	Max. 100m ohm (at 1A 6VDC)	
	Max. Switching Power	37.5AV / 30W	
	Max. Switching Voltage	250VAC, 220 VDC	
	Max. Switching Current	1 A	
Coil	Operating Temperature	-40° C to + 85° C (no frost)	
	Max. Allowable Voltage	150% nominal voltage (at 20° C)	
Time Value	Operate Time	Max. 10ms (at nominal voltage, without bounce)	
	Release Time (without diode)	Max. 10ms (at nominal voltage, without bounce)	
Insulation	Resistance (at 500 VDC)		Min. 1,000M ohm S
	Dielectric Strength	Between open contacts	1,500VAC, 1 minute
		Between adjacent contacts	1,500VAC, 1 minute
		Between coil and contacts	3,000VAC, 1 minute
	Surge Strength	Between open contacts	2,500V (at 2/10 microsec)
		Between adjacent contacts	2,500V (at 2/10 microsec)
Between coil and contacts		5,000V (at 2/10 microsec)	
Life	Mechanical	10x10 <sup>6</sup> operations min. (at 10Hz)	
	Electrical (resistive load)	100x10 <sup>3</sup> operations min. at 1A, 30VDC, 0.5Hz 100x10 <sup>3</sup> operations min. at 0.1A, 48VDC, 0.5Hz 100x10 <sup>3</sup> operations min. at 0.3A, 125VDC, 0.5Hz	
Vibration Resistance	Misoperation	10 to 55 Hz at double amplitude of 3.3 mm	
	Endurance	10 to 55 Hz at double amplitude of 5 mm	
Shock Resistance	Misoperation	Min. 500 m/s <sup>2</sup>	
	Endurance	Min. 1,000 m/ s <sup>2</sup>	
UL / CSA	Contact Rating	0.3A 125 VAC 1A 30VDC 0.3 110VDC	
IEC060950 UL1950 C22.2 No.950 EN60950	Insulation Class	Supplementary Insulation	
	Working Voltage	250 V	
	Pollution Degree	2	
	Clearance	2.0 mm (between coil and contacts)	
	Creepage Distance	2.5 mm (between coil and contacts)	

## ■ DIMENSIONS AND SCHEMATICS

Through hole type

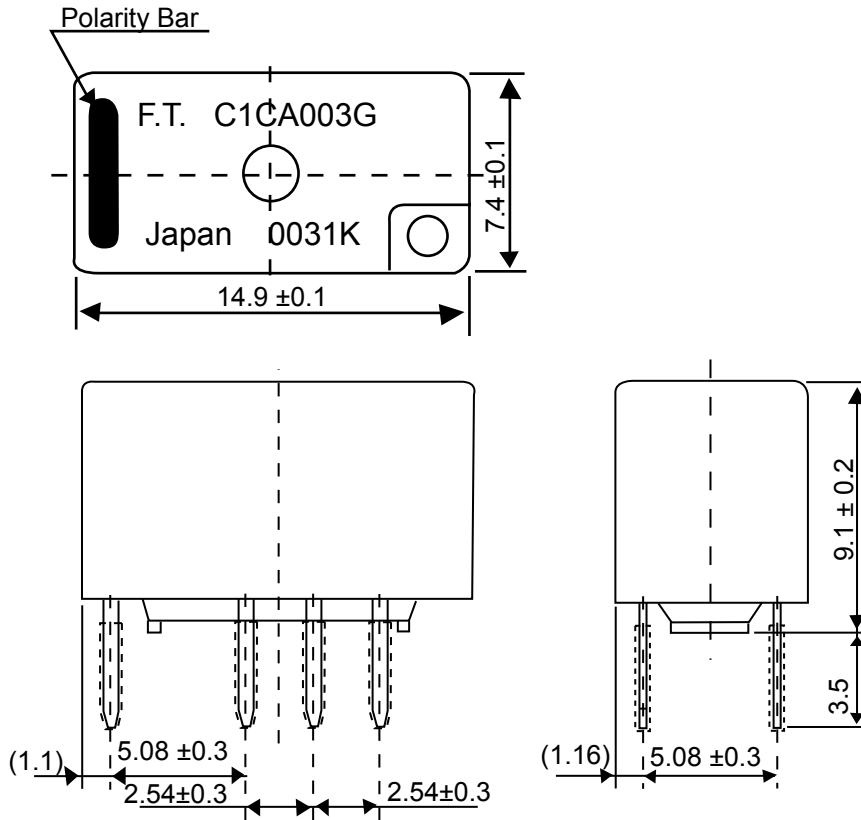

Unit: mm

## ■ TERMINAL DESIGNATIONS

Standard type  
(Bottom view de-energized position)

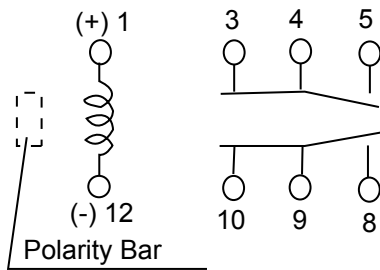

Single Coil Latching type  
(Bottom view reset position)

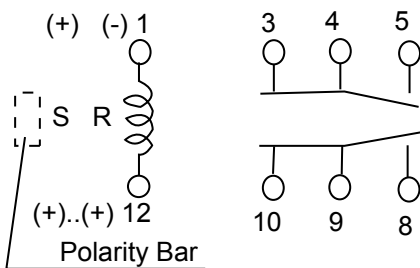

## ■ RECOMMENDED MOUNTING PAD

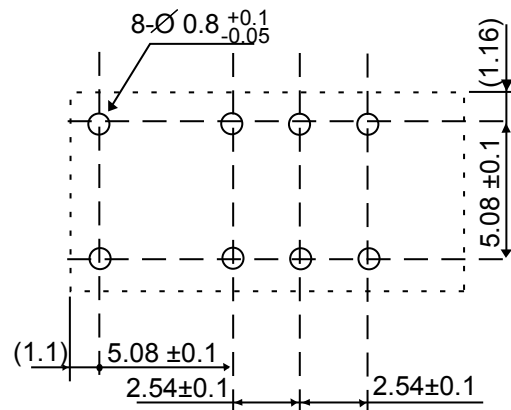

S shows the polarity of set position  
R shows the polarity of reset position

Unit: mm

# FTR-C1 Series

## ■ DIMENSIONS AND SCHEMATICS

Surface mount type

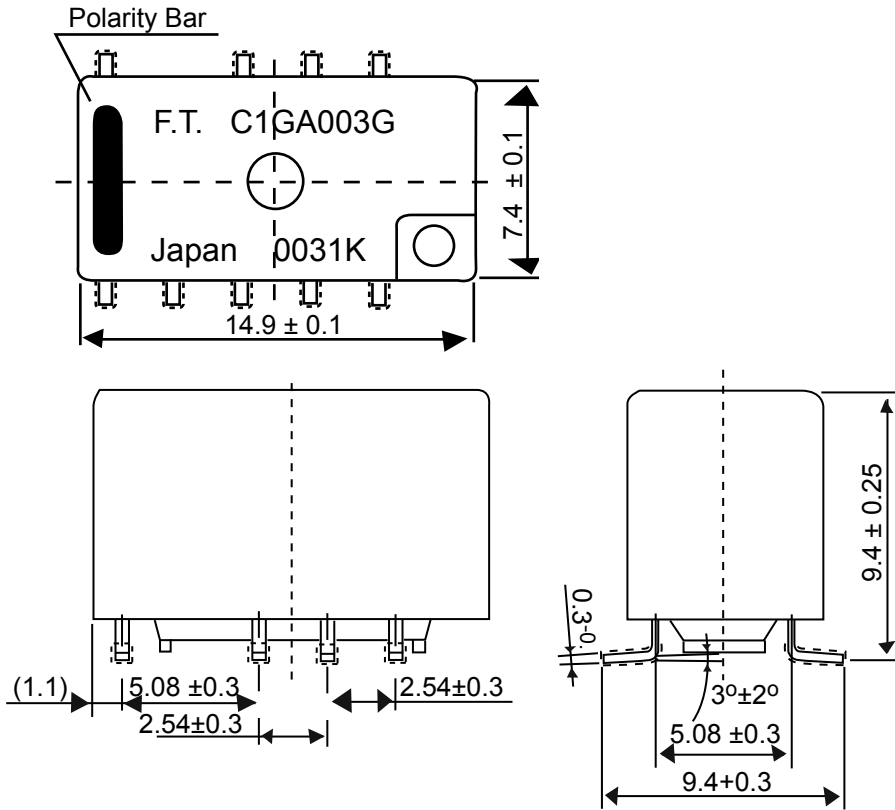

Unit: mm

## ■ TERMINAL DESIGNATIONS

Standard type

(Top view de-energized position)

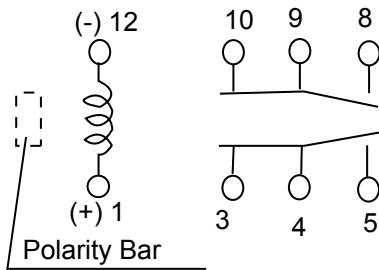

Single Coil Latching type

(Bottom view reset position)

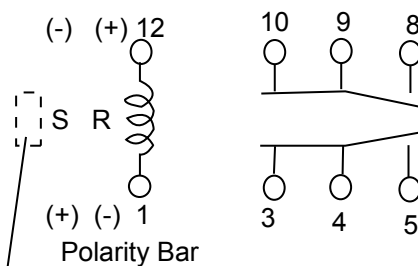

## ■ RECOMMENDED MOUNTING PAD

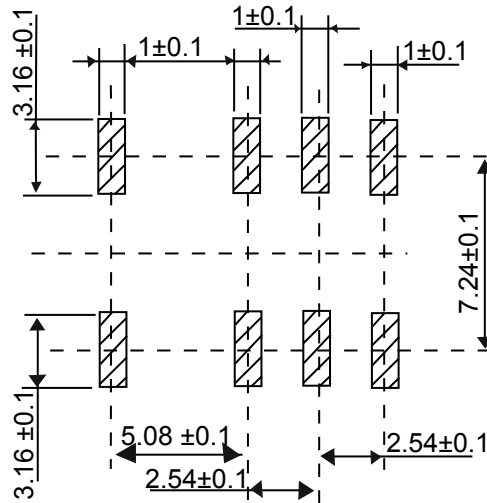

S shows the polarity of set position  
R shows the polarity of reset position

Unit: mm

# FTR-C1 Series

## ■ RECOMMENDED SOLDERING CONDITIONS (TEMPERATURE PROFILE)

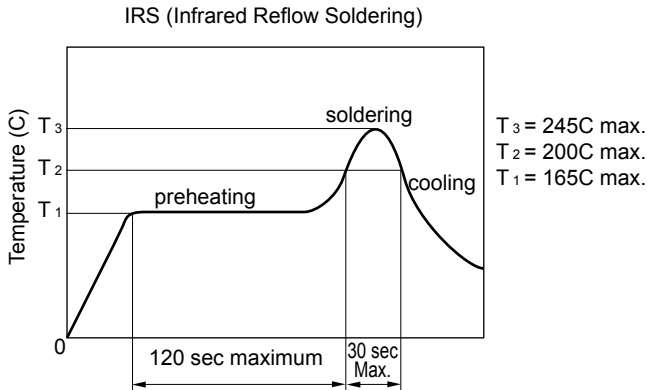

- Note:
1. Temperature profiles show the temperature of PC board surface.
  2. Please perform soldering test with your actual PC board before mass production, since the temperatures of PC board surfaces vary according to the size of PC board, status of parts mounting and heating method.

## ■ PACKAGING

Packaging method (only tape packaging is available)

1. Taping standards: JIS C 0806 and RC-10092B (EIAJ)
2. Reel type: TB2416 or TB2416
3. Reel type: RD24D
4. Quantity of 1 reel: 500 pieces

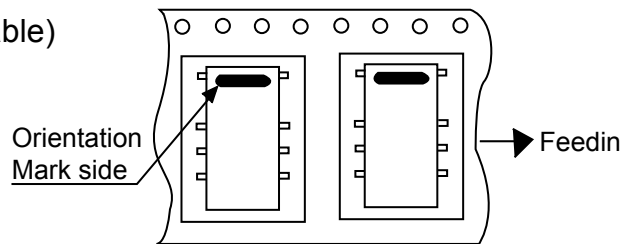

Tape Dimensions:

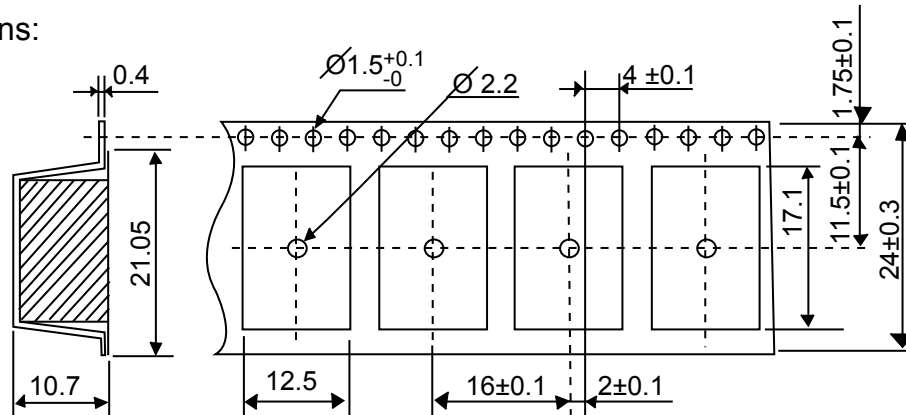

Reel Dimensions:

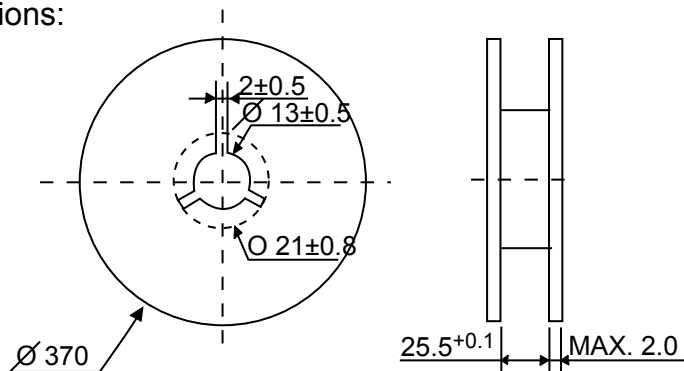

Unit: mm

## RoHS Compliance and Lead Free Relay Information

### 1. General Information

- Relays produced after the specific date code that is indicated on each data sheet are lead-free now. Most of our signal and power relays are lead-free. Please refer to Lead-Free Status Info. (<http://www.fujitsu.com/us/downloads/MICRO/fcai/relays/lead-free-letter.pdf>)
- Lead free solder paste currently used in relays is Sn-3.0Ag-0.5Cu.
- All signal and most power relays also comply with RoHS. Please refer to individual data sheets. Relays that are RoHS compliant do not contain the 5 hazardous materials that are restricted by RoHS directive (lead, mercury, chromium IV, PBB, PBDE).
- It has been verified that using lead-free relays in leaded assembly process will not cause any problems (compatible).
- "LF" is marked on each outer and inner carton. (No marking on individual relays).
- To avoid leaded relays (for lead-free sample, etc.) please consult with area sales office.
- We will ship leaded relays as long as the leaded relay inventory exists.

Note: Cadmium was exempted from RoHS on October 21, 2005. (Amendment to Directive 2002/95/EC)

### 2. Recommended Lead Free Solder Profile

- Recommended solder paste Sn-3.0Ag-0.5Cu and Sn-3.0 Cu-Ni (only FTR-B3 and FTR-B4 from February 2005).

#### Reflow Solder condition for SMT

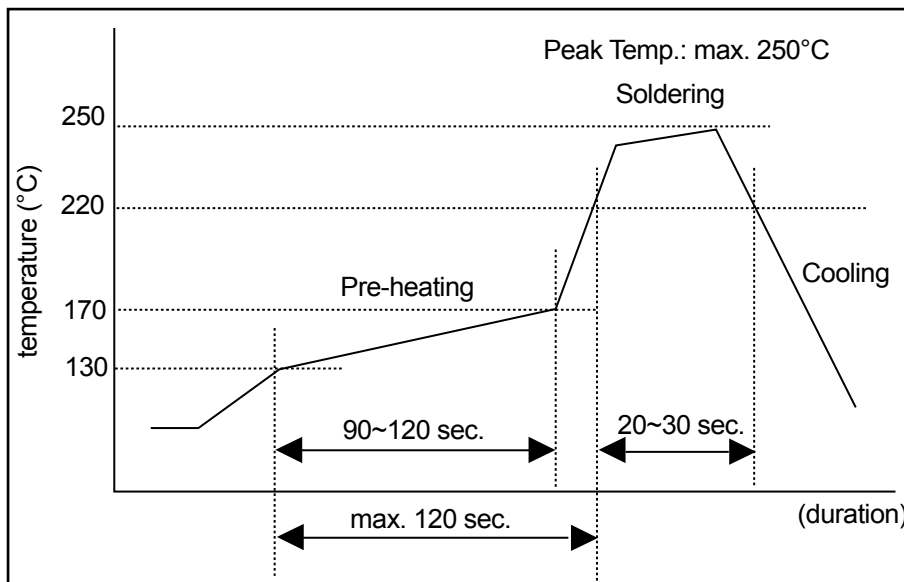

#### Flow Solder condition:

Pre-heating: maximum 120°C  
Soldering: dip within 5 sec. at 260°C solder bath

#### Solder by Soldering Iron:

Soldering Iron  
Temperature: maximum 360°C  
Duration: maximum 3 sec.

We highly recommend that you confirm your actual solder conditions

### 3. Moisture Sensitivity

- Moisture Sensitivity Level standard is not applicable to electromechanical relays.

### 4. Tin Whisker

- SnAgCu and SnCuNi solder is known as low risk of tin whisker. No considerable length whisker was found by our in-house test.

## Fujitsu Components International Headquarter Offices

### Japan

Fujitsu Component Limited  
Gotanda-Chuo Building  
3-5, Higashigotanda 2-chome, Shinagawa-ku  
Tokyo 141, Japan  
Tel: (81-3) 5449-7010  
Fax: (81-3) 5449-2626  
Email: [promothq@ft.ed.fujitsu.com](mailto:promothq@ft.ed.fujitsu.com)  
Web: [www.fcl.fujitsu.com](http://www.fcl.fujitsu.com)

### North and South America

Fujitsu Components America, Inc.  
250 E. Caribbean Drive  
Sunnyvale, CA 94089 U.S.A.  
Tel: (1-408) 745-4900  
Fax: (1-408) 745-4970  
Email: [components@us.fujitsu.com](mailto:components@us.fujitsu.com)  
Web: <http://us.fujitsu.com/components/>

### Europe

Fujitsu Components Europe B.V.  
Diamantlaan 25  
2132 WV Hoofddorp  
Netherlands  
Tel: (31-23) 5560910  
Fax: (31-23) 5560950  
Email: [info@fceu.fujitsu.com](mailto:info@fceu.fujitsu.com)  
Web: <http://www.fujitsu.com/emea/services/components/>

### Asia Pacific

Fujitsu Components Asia Ltd.  
102E Pasir Panjang Road  
#04-01 Citilink Warehouse Complex  
Singapore 118529  
Tel: (65) 6375-8560  
Fax: (65) 6273-3021  
Email: [fcal@fcal.fujitsu.com](mailto:fcal@fcal.fujitsu.com)  
Web: <http://www.fujitsu.com/sg/services/micro/components/>

©2007 Fujitsu Components America, Inc. All rights reserved. All trademarks or registered trademarks are the property of their respective owners.

Fujitsu Components America does not warrant that the content of datasheet is error free. In a continuing effort to improve our products Fujitsu Components America, Inc. reserves the right to change specifications/datasheets without prior notice. Rev. April 13, 2007