

General Description

It is mainly suitable for battery pack or power management in cell phone, and PDA.

FEATURES

- $V_{DSS} = -20V$, $I_D = -10A$.
- Drain-Source ON Resistance.
 - : $R_{DS(ON)} = 14m\ \Omega$ (Max.) @ $V_{GS} = -4.5V$, $I_D = -10A$.
 - : $R_{DS(ON)} = 24m\ \Omega$ (Max.) @ $V_{GS} = -2.5V$, $I_D = -7.6A$.

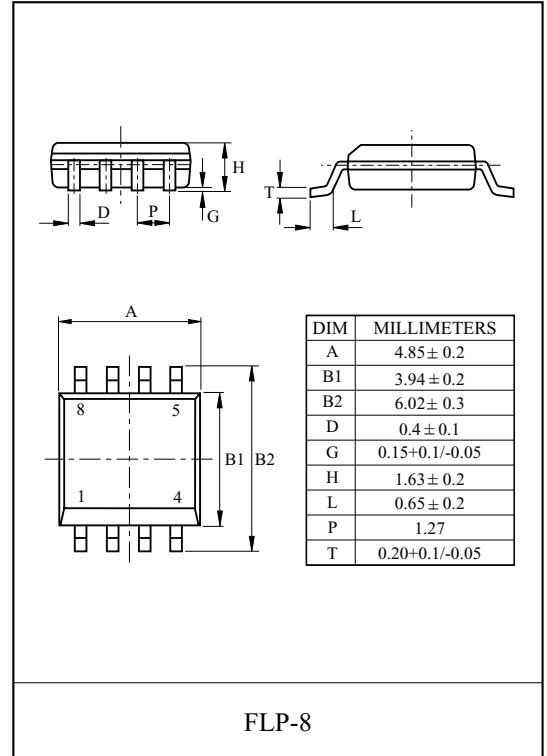

MAXIMUM RATING (Ta=25 °C)

CHARACTERISTIC		SYMBOL	RATING	UNIT
Drain-Source Voltage		V_{DSS}	-20	V
Gate-Source Voltage		V_{GSS}	±12	V
Drain Current	DC	I_D^*	±10	A
	Pulsed (Note1)	I_{DP}^*	±48	
Source-Drain Diode Current		I_S^*	-2.3	A
Drain Power Dissipation	Ta=25 °C	P_D^*	1.6	W
	Ta=100 °C		0.625	
Maximum Junction Temperature		T_j	150	°C
Storage Temperature Range		T_{stg}	-55 ~ 150	°C
Thermal Resistance, Junction to Ambient		R_{thJA}^*	80	°C/W

* : Surface Mounted on 1" × 1" FR4 Board, t ≤ 5sec.

PIN CONNECTION (TOP VIEW)

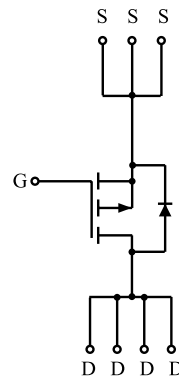
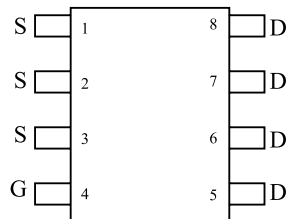

KMA010P20Q

ELECTRICAL CHARACTERISTICS (Ta=25 °C)

CHARACTERISTIC	SYMBOL	TEST CONDITION	MIN.	TYP.	MAX.	UNIT
Static						
Drain-Source Breakdown Voltage	BV _{DSS}	I _D =-250 μA, V _{GS} =0V,	-20	-	-	V
Drain Cut-off Current	I _{DSS}	V _{GS} =0V, V _{DS} =-20V	-	-	-1	μA
		V _{GS} =0V, V _{DS} =-16V, T _j =70 °C	-	-	-5	
Gate Threshold Voltage	V _{th}	V _{DS} =V _{GS} , I _D =-250 μA	-0.6	-	-	V
Gate Leakage Current	I _{GSS}	V _{GS} =±12V, V _{DS} =0V	-	-	±100	nA
Drain-Source ON Resistance	R _{DS(ON)}	V _{GS} =-4.5V, I _D =-10A (Note 1)	-	11	14	m Ω
		V _{GS} =-2.5V, I _D =-7.6A (Note 1)	-	18	24	
ON State Drain Current	I _{D(ON)}	V _{GS} =-4.5V, V _{DS} =-5V (Note 1)	-48	-	-	A
Forward Transconductance	g _{fs}	V _{DS} =-5V, I _D =-10A (Note 1)	-	31	-	S
Source-Drain Diode Forward Voltage	V _{SD}	I _S =-10A, V _{GS} =0V (Note 1)	-	-	-1.1	V
Dynamic (Note 2)						
Total Gate Charge	Q _g	V _{DS} =-10V, R _D =1.0 Ω V _{GS} =-4.5V (Fig.1)	-	36	-	nC
Gate-Source Charge	Q _{gs}		-	5	-	
Gate-Drain Charge	Q _{gd}		-	13	-	
Turn-on Delay time	t _{d(on)}	V _{DD} =-10V, R _D =1.0 Ω, V _{GS} =-4.5V, R _G =6 Ω (Fig.2)	-	10	-	ns
Turn-on Rise time	t _r		-	72	-	
Turn-off Delay time	t _{d(off)}		-	78	-	
Turn-off Fall time	t _f		-	108	-	

Note 1) Pulse test : Pulse width ≤300 μs, Duty Cycle ≤2%.

Note 2) Guaranteed by design. Not subject to production testing.

KMA010P20Q

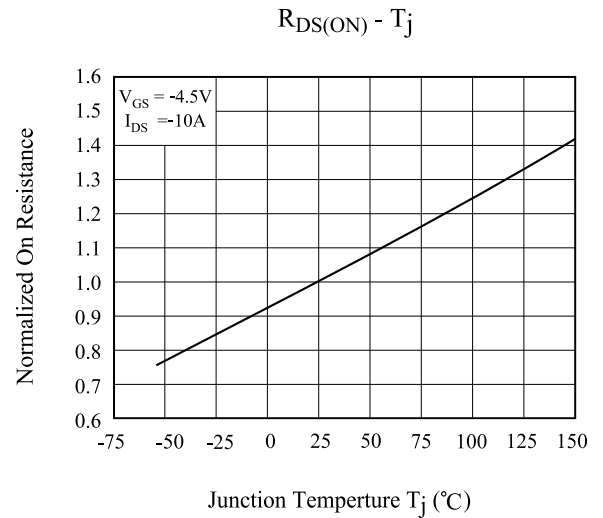
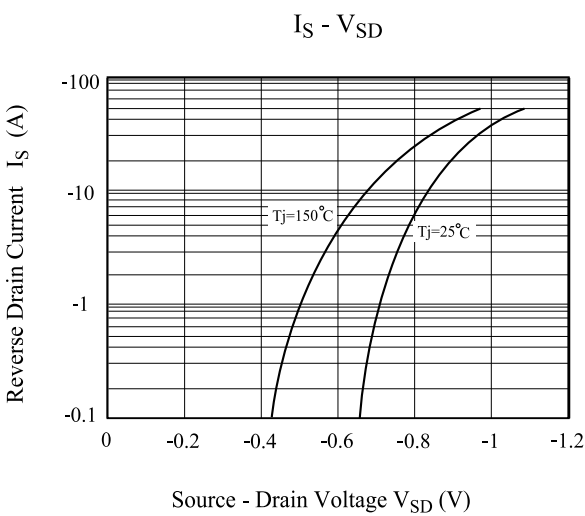
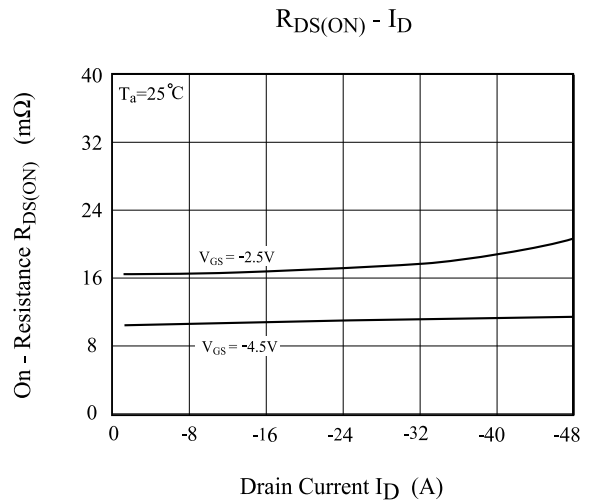
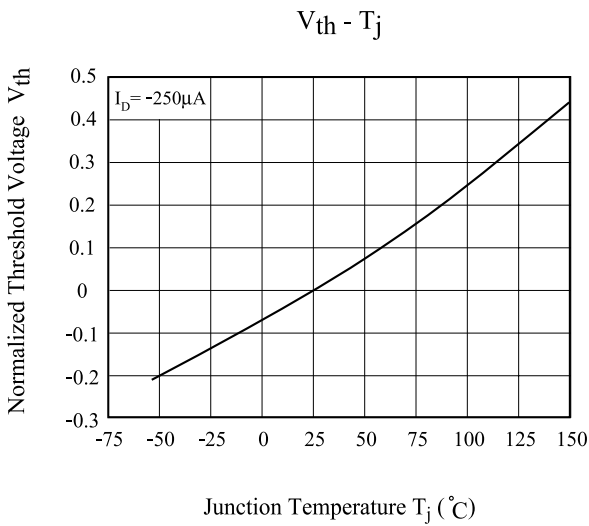
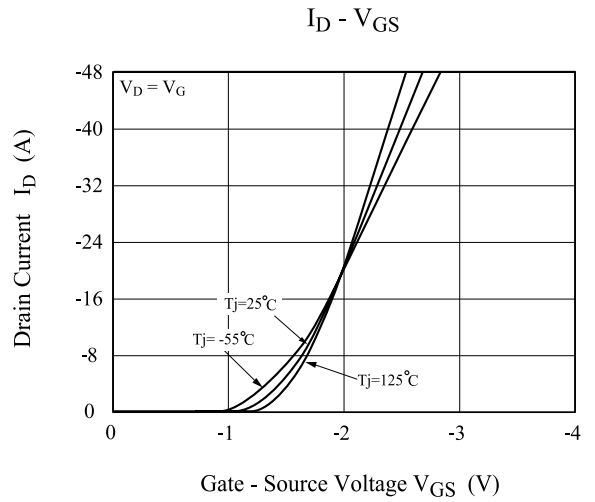
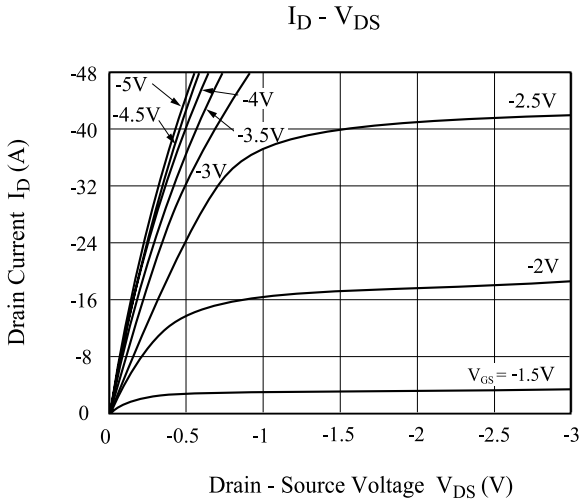

KMA010P20Q

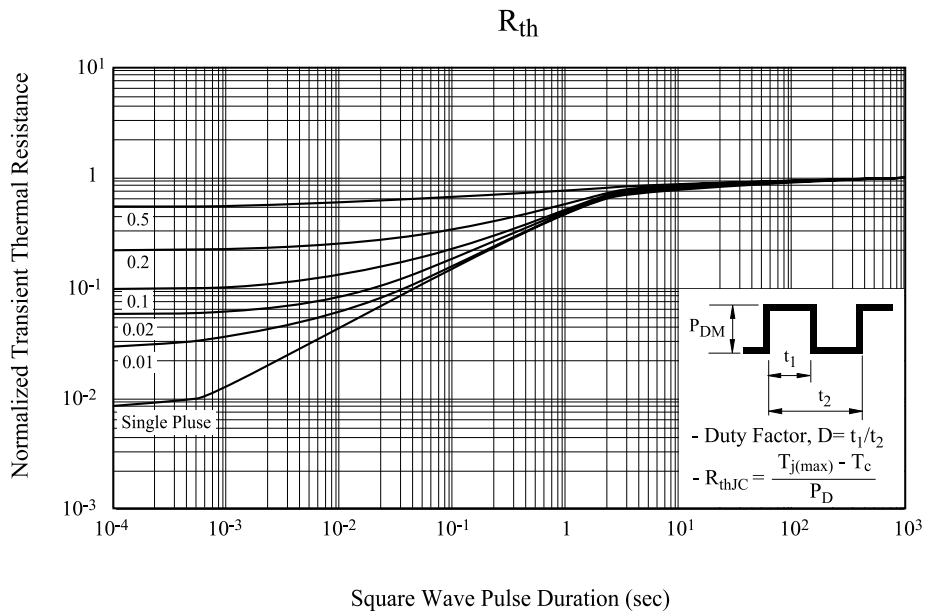
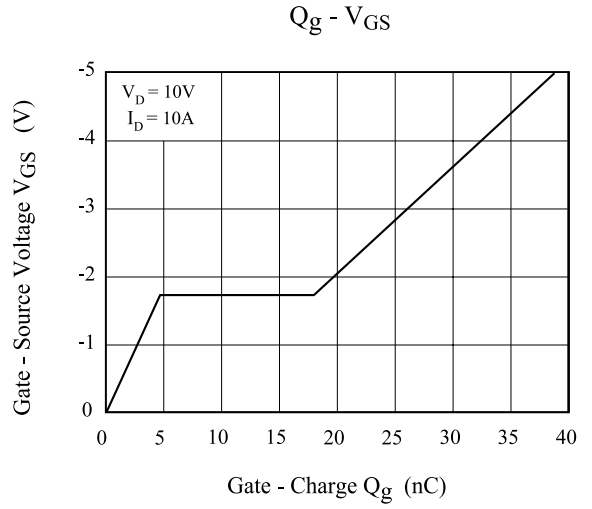
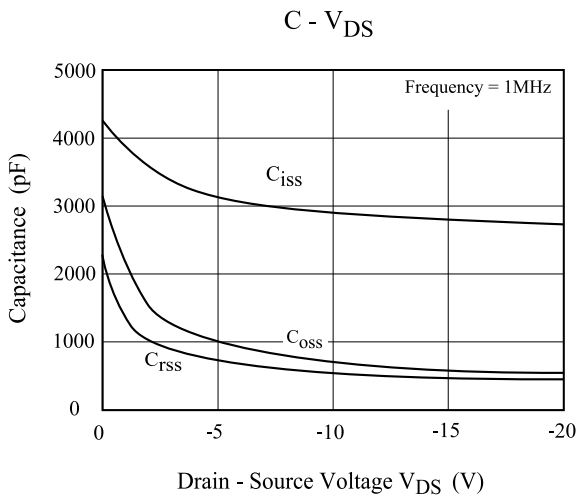

KMA010P20Q

Fig. 1 Gate Charge

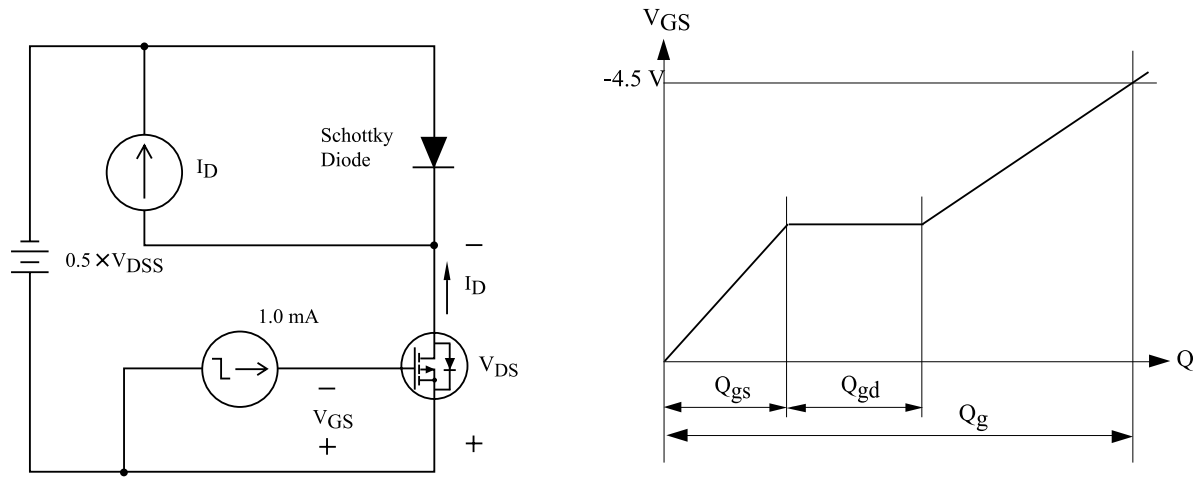

Fig. 2 Resistive Load Switching

