

# 2.3 to 2.5 GHz 1 Watt Power Amplifier

## Features

- ✕ 48% Power Added Efficiency
- ✕ 31.5 dBm Output Power
- ✕ Low Distortion
- ✕ Low Cost SO-8 Surface Mount Package

## General Description

The CMM2321 is a power amplifier intended for use in 2.4 GHz ISM band applications such as wireless datacom equipment, wireless bar code scanners and inter-building campus networks. This flexible amplifier can be biased to support the requirements of frequency hopping or direct sequence systems. The CMM2321 is packaged in a low-cost, space efficient SO-8 power package that gives excellent electrical stability and thermal handling performance with a  $R_{\theta}$  of less than 18° C/W. The part is designed to require minimal external circuitry for bias matching, simplifying design and keeping board space and cost to a minimum.

## Functional Block Diagram

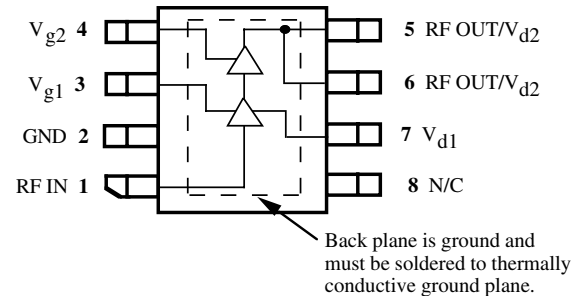

## Applications

- ✕ Wireless Datacom
- ✕ Wireless Bar Code Scanners
- ✕ Inter-Building Campus Networks

## Absolute Maximum Ratings

Parameter	Rating	Parameter	Rating	Parameter	Rating
Drain Voltage (+V <sub>d</sub> )	+9.0 V*	Power Dissipation	5 W	Operating Temperature	-40°C to +100°C
Drain Current (I <sub>d</sub> )	1.8 A	Thermal Resistance	18°C/W	Channel Temperature	175°C
RF Input Power	+15 dBm*	Storage Temperature	-65°C to +150°C	Soldering Temperature	260°C for 5 Sec.
DC Gate Voltage (-V <sub>g</sub> )	-4.0 V*				

\* Max (+V<sub>d</sub>) and (-V<sub>g</sub>) under linear operation. Max potential difference across the device in RF compression (2V<sub>d</sub> - |V<sub>g</sub>|) not to exceed the minimum breakdown voltage (V<sub>br</sub>) of +18V.

## Recommended Operating Conditions

Parameter	Typ	Units	Parameter	Typ	Units
Drain Voltage (+V <sub>d</sub> )	4.5 to 5.1	Volts	Operating Temperature (PC Board)	-30 to +80	°C

## Electrical Characteristics

The following specifications are guaranteed at room temperature with drain voltage (+V<sub>d</sub>) = 4.8 V @ 2.45 GHz in Celeritek test fixture.

Parameter	Condition	Min	Typ	Max	Units
Frequency Range		2.3		2.5	GHz
P <sub>-1dB</sub>		30	30.5		dBm
P <sub>OUT</sub> Saturated	P <sub>IN</sub> = +14 dBm	31	31.5		dBm
Efficiency (PAE)	@ Saturation		48		%
Gain		18	20		dB
Harmonics	2nd @ P <sub>out</sub> = +30 dBm 3rd @ P <sub>out</sub> = +30 dBm		-35 -40	-30 -35	dBc dBc
Noise Figure			5.0		dB
Return Loss			10		dB
Negative Supply Current (-I <sub>g</sub> )			0.5	1.0	mA
Positive Supply Current (I <sub>d</sub> )	@ P <sub>-1dB</sub>		675		mA

# 2.3 to 2.5 GHz 1 Watt Power Amplifier

## Typical Performance

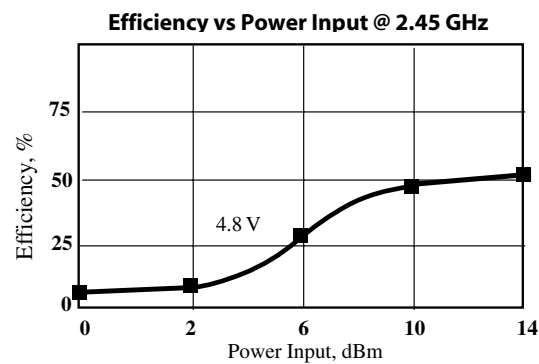
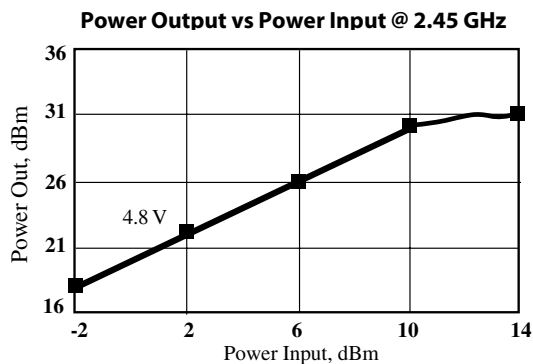
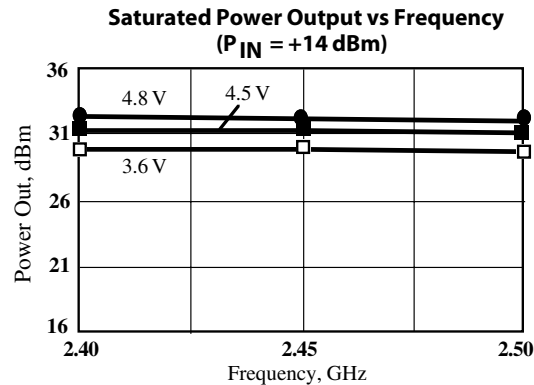
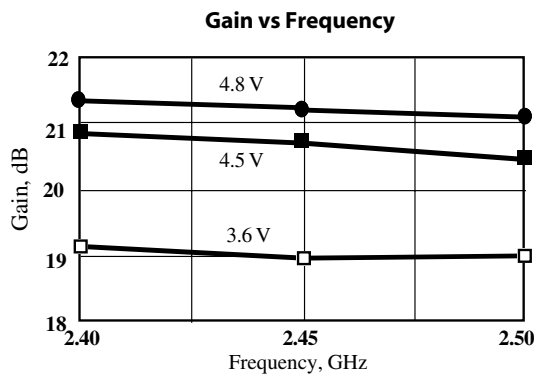

## Application Information

The CMM2321 is a two stage amplifier that requires a positive and negative supply voltage for proper operation. It is essential when turning on the device that the negative supply be applied before the positive supply. When turning the device off, the positive supply should be removed before the negative supply is removed.

The CMM2321 can be operated over a range of supply voltages and bias points. It is important that the maximum power dissipation of the package be observed at all times.

## Design Considerations

**Biasing** A negative voltage supply is needed to bias the gates of the 2-stage GaAs FET power amplifier. Gate 1 bias is applied through pin 3 (Vg1) and gate 2 bias is applied through pin 4 (Vg2). Under most operating conditions gates 1 and 2 may be tied together. The positive supply voltage is applied to pins 5 and 6 (Vd2) and pin 7 (Vd1). The negative voltage supply should be adjusted to achieve a drain current of 600 mA with no RF input power to obtain a P1dB of approximately 30.5 dBm.

**Matching Circuits** Input and output matching circuits are required. The schematic and the PCB layout for the test board are shown on Page 3. The matching circuits for the CMM2321 are highlighted on the PCB layout.

A single shunt capacitor is used to match the output.

Their placement and value provide tuning. Vd2 is fed through a  $\lambda/4$  trace. All other capacitors shown in the schematic are used for decoupling.

Note: Circuit board 8251 is a multiple-use test board. The portions of the board that are used with the CMM2321 are shown as solid traces on the board layout drawing on Page 3. The interface/conversion points in the evaluation board schematic are shown. These connection points may not be labeled identically on Mimix's PB-CMM2321 evaluation board. Contact the factory for assistance in translating the external match to a specific application.

**Supply Ramping** To obtain the necessary power ramp, supply side switching should be used. Both drain voltages should be tied together and ramped to produce the required power vs. time response.

### Thermal

1. The copper pad on the backside of the CMM2321 must be soldered to the ground plane.
2. All 8 leads of the package must be soldered to the appropriate electrical connection.
3. A large ground plane area with plated thru-holes as shown on the PCB layout should be used as a backside connection.

Contact the factory for a copy of a manufacturing application note containing more detailed information.

# 2.3 to 2.5 GHz 1 Watt Power Amplifier

August 2007 - Rev 05-Aug-07

CMM2321-AK

## Test Circuits

### Evaluation Board Schematic

Board substrate:  
ER = 4.60  
Thickness = 0.031 in.

Transmission line electrical  
lengths at 2.45 GHz.  
(Dimensions in inches)

Line	Z (Ω)	E (°)
T1	104	14
T2	104	19
T3	50	11
T4	53	31
T5	91	82

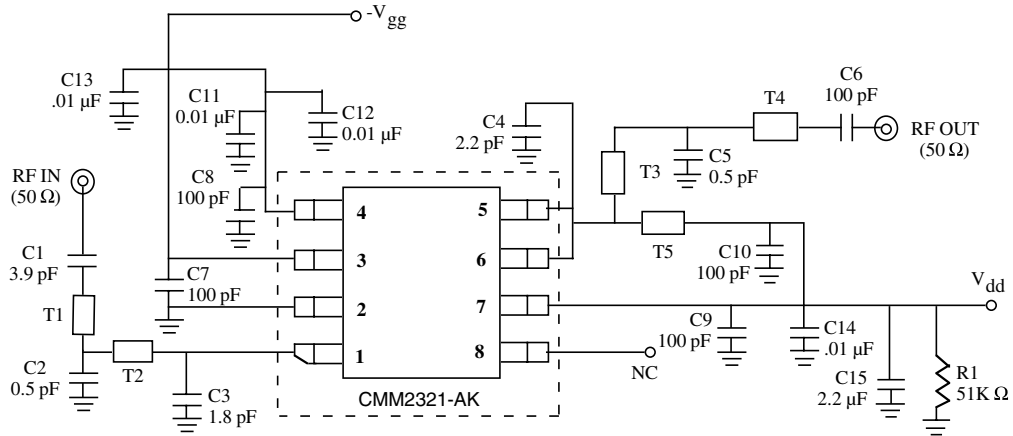

## PB-CMM2321 Evaluation Board

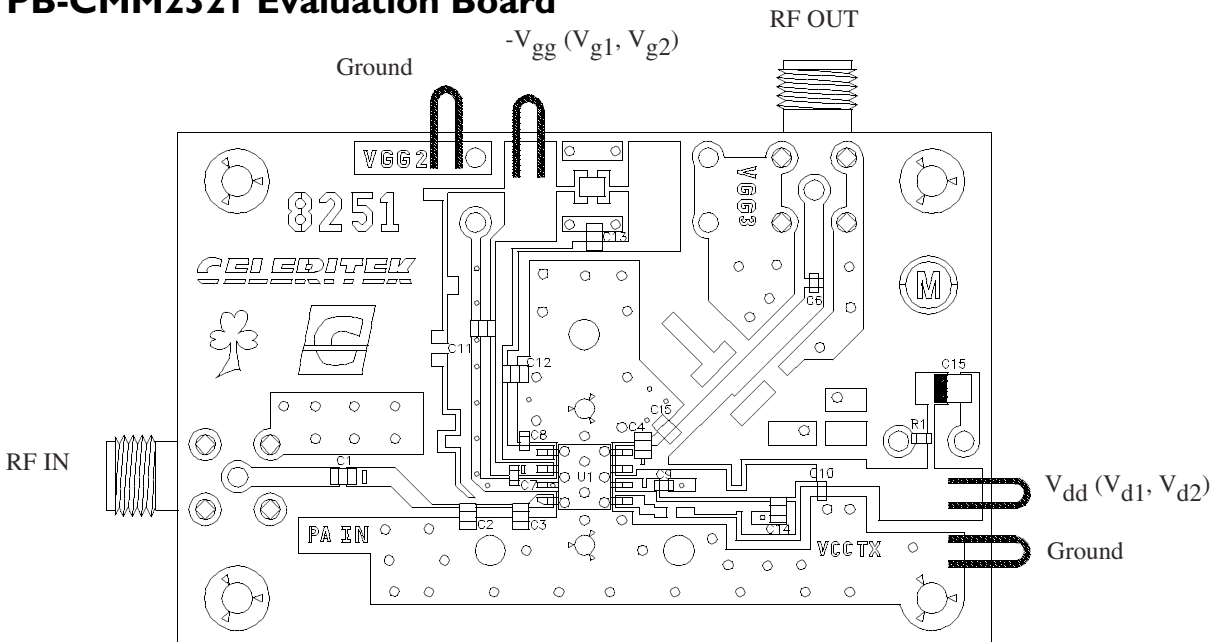

## Evaluation Board Parts List

Part Type	Reference Designator	Description	Manufacturer	Part Number
Resistor	R1	51 KΩ 0603	Rohm	MCR 03J 513
Capacitor	C1	3.9 pF 0805 NPO	Rohm	MCH 185 A3R9CK
Capacitor	C2, C5	0.5 pF 0805 NPO	Rohm	MCH 185 A0R5CK
Capacitor	C3	1.8 pF 0805 NPO	Rohm	MCH 185 A1R8CK
Capacitor	C4	2.2 pF 0805 NPO	Rohm	MCH 185 A2R2CK
Capacitor	C6, C7, C8, C9, C10	100 pF 0805 NPO	Rohm	MCH 185 A101JK
Capacitor	C11, C12, C13, C14	0.01 μF 0805 X7R	Rohm	MCH 215 C103KK
Capacitor	C15	2.2 μF Tantalum	Matsuo	267 M2002225M

# 2.3 to 2.5 GHz 1 Watt Power Amplifier

## Connection Diagram and Pin Descriptions

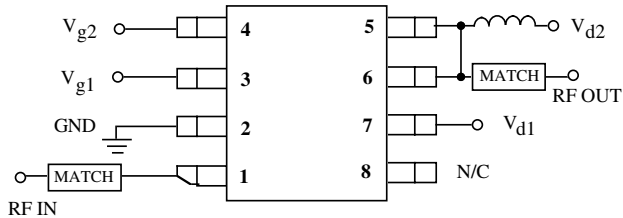

Pin #	Name	Description
1	RF IN	RF input (internally DC blocked)
2	GND	Ground
3	V <sub>g1</sub>	Input stage gate bias
4	V <sub>g2</sub>	Output stage gate bias
5	RF OUT/V <sub>d2</sub>	RF output and V <sub>d2</sub> . External matching circuit required
6	RF OUT/V <sub>d2</sub>	RF output and V <sub>d2</sub> . External matching circuit required
7	V <sub>d1</sub>	Input stage drain bias
8	N/C	Ground this pin

## Physical Dimensions

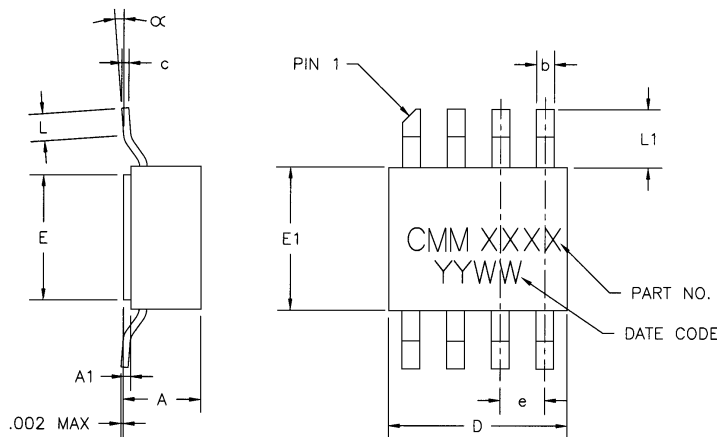

DIMENSION	MINIMUM	NOMINAL	MAXIMUM
A		.086[2.184]	.100[2.540]
A1	.005[.1270]	.008[.2032]	.011[.2794]
b	.017[.4318]	.020[.5080]	.023[.5842]
c	.007[.1778]	.008[.2032]	.009[.2286]
D	.195[4.953]	.200[5.080]	.205[5.207]
E	.135[3.429]	.140[3.556]	.145[3.683]
E1	.155[3.937]	.160[4.064]	.165[4.191]
e		.050[1.270]	
L	.020[.5080]		.040[1.016]
L1	.055[1.397]	.065[1.651]	.075[1.905]
alpha	0°		8°

DIMENSIONS IN INCHES [MILLIMETERS]

## Ordering Information

The CMM2321 is available in a surface mount SO-8 power package and devices are available in tape and reel.

### Part Number for Ordering

CMM2321-AK  
CMM2321-AK-000T  
PB-CMM2321-AK

### Package

SO-8 surface mount power package  
SO-8 surface mount power package in tape and reel  
Evaluation Board with SMA connectors