

# M210x Series

5x7 mm, 3.3/2.5/1.8 Volt, LVPECL/LVDS/CML, Clock Oscillator



## Ordering Information

	M210	0	6	8	B	P	N	00.0000	MHz
Product Series									
Supply Voltage									
0: 3.3 V	1: 2.5 V								
2: 1.8 V									
Temperature Range									
2: -40°C to +85°C (see Note 1)									
6: -20°C to +70°C									
Stability									
4: ±50 ppm	3: 100 ppm								
8: ±20 ppm									
Enable/Disable									
B: Enable High (pin 1)	G: Enable High (pin 2)								
S: Enable Low (pin 1)	M: Enable Low (pin 2)								
U: No Enable/Disable									
Logic Type									
P: LVPECL	L: LVDS								
M: CML									
Package/Lead Configuration									
N: 5x7 mm Leadless									
Frequency (customer specified)									

### Features:

- Featuring *QiK Chip™* Technology
- Superior Jitter Performance (comparable to SAW based)
- Frequencies from 150 MHz to 1.4 GHz
- Designed for a short 2 week cycle time

### Applications:

- Telecommunications such as SONET / SDH / DWDM / FEC / SERDES / OC-3 thru OC-192
- Wireless base stations / WLAN / Gigabit Ethernet
- Avionic flight controls and military communications

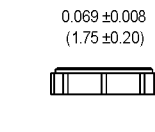
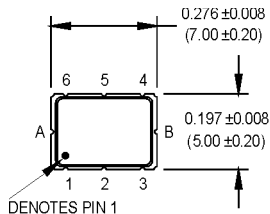

ACTUAL SIZE



All dimensions in inches (mm).



### PIN 1 ENABLE

- Pad1: Enable/Disable
- Pad2: N/C
- Pad3: Ground
- Pad4: Output Q (LVPECL, LVDS, CML)
- Pad5: Output  $\bar{Q}$  (LVPECL, LVDS, CML)
- Pad6: Vcc
- PadA: Do not connect!
- PadB: Do not connect!
- PadC: Do not connect!

### PIN 2 ENABLE

- Pad1: N/C
- Pad2: Enable/Disable
- Pad3: Ground
- Pad4: Output Q (LVPECL, LVDS, CML)
- Pad5: Output  $\bar{Q}$  (LVPECL, LVDS, CML)
- Pad6: Vcc
- PadA: Do not connect!
- PadB: Do not connect!
- PadC: Do not connect!

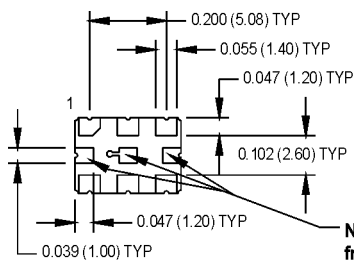

**NOTE: These 3 pads must be isolated from any traces or vias appearing beneath this port.**

### SUGGESTED SOLDER PAD LAY OUT

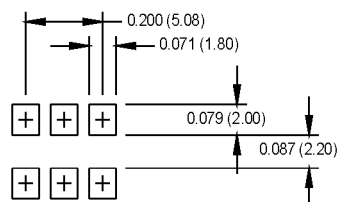

MtronPTI reserves the right to make changes to the product(s) and service(s) described herein without notice. No liability is assumed as a result of their use or application.

Please see [www.mtronpti.com](http://www.mtronpti.com) for our complete offering and detailed datasheets. Contact us for your application specific requirements: MtronPTI 1-800-762-8800.

Revision: 8-16-06

# M210x Series

5x7 mm, 3.3/2.5/1.8 Volt, LVPECL/LVDS/CML, Clock Oscillator



PARAMETER	Symbol	Min.	Typ.	Max.	Units	Condition/Notes	
Frequency Range	F	150		1400	MHz	See Note 2	
Operating Temperature	T <sub>A</sub>	(See ordering information)					See Note 1
Storage Temperature	T <sub>S</sub>	-55		+125	°C		
Frequency Stability	ΔF/F	(See ordering information)					See Note 3
<b>Aging</b>							
1st Year		-3		+3	ppm		
Thereafter (per year)		-1		+1	ppm		
Supply Voltage	V <sub>cc</sub>	1.71	1.8	1.89	V		
		2.375	2.5	2.625	V		
		3.135	3.3	3.465	V		
Input Current	I <sub>cc</sub>			125	mA	LVPECL/LVDS/CML	
Load		50 Ohms to (V <sub>cc</sub> - 2) V <sub>dc</sub> 100 Ohm differential load				See Note 4 LVPECL Waveform LVDS/CML Waveform	
Symmetry (Duty Cycle)		45		55	%	@ 50% of waveform	
Output Skew			TBD				
Differential Voltage		350	425 TBD	500	mVppd	LVDS CML	
Common Mode Output Voltage	V <sub>cm</sub>		1.2		V	LVDS	
Logic "1" Level	V <sub>oh</sub>	V <sub>cc</sub> - 1.02			V	LVPECL	
Logic "0" Level	V <sub>ol</sub>			V <sub>cc</sub> - 1.63	V	LVPECL	
Rise/Fall Time	T <sub>r</sub> /T <sub>f</sub>		0.23	0.50	ns	@ 20/80% LVPECL	
Enable Function		80% V <sub>cc</sub> min. or N/C: output active 20% V <sub>cc</sub> max.: output disables to high-Z				Output Option B or G	
		20% V <sub>cc</sub> max.: output active 80% V <sub>cc</sub> min.: output disables to high-Z				Output Option S or M	
Start up Time			10		ms		
Phase Jitter @ 622.08 MHz	φ <sub>J</sub>		0.3		ps RMS	Integrated 12 kHz – 20 MHz	
Phase Noise						@ 622.08 MHz	
10 Hz			-50			dBc/Hz	
100 Hz			-80			dBc/Hz	
1 KHz			-106			dBc/Hz	
10 KHz			-117			dBc/Hz	
100 KHz			-120			dBc/Hz	
1 MHz			-130			dBc/Hz	
10 MHz			-147			dBc/Hz	
40 MHz			-150			dBc/Hz	
<b>Environmental</b>							
Mechanical Shock		Per MIL-STD-202, Method 213, Condition C (100 g's, 6 ms duration, ½ sinewave)					
Vibration		Per MIL-STD-202, Method 201 & 204 (10 g's from 10-2000 Hz)					
Hermeticity		Per MIL-STD-202, Method 112, (1x10 <sup>-5</sup> atm. cc/s of Helium)					
Thermal Cycle		Per MIL-STD-883, Method 1010, Condition B (-55°C to +125°C, 15 min. dwell, 10 cycles)					
Solderability		Per EIAJ-STD-002					
Soldering Conditions		+240°C max. for 10 secs.					

- Note 1: If the device is powered up below -20°C and then the ambient temperature rises 105°C during normal operation, the output will be interrupted for approximately 2-3 ms. A correction is in process and will be available Q1 2007.
- Note 2: Contact factory for exact frequency availability over 945 MHz
- Note 3: Stability is inclusive of initial tolerance, deviation over temperature, shock, vibration, supply voltage, and aging for one year at 50°C mean ambient temperature.
- Note 4: See Load Circuit Diagram in this Datasheet. Consult factory with nonstandard output load requirements.

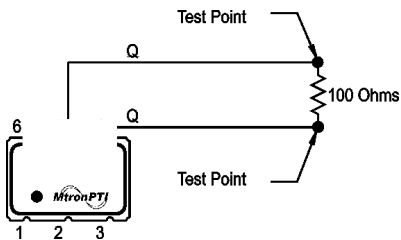

LVDS Load Circuit

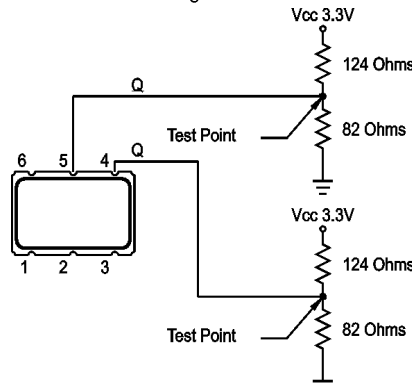

3.3V LVPECL Load Circuit

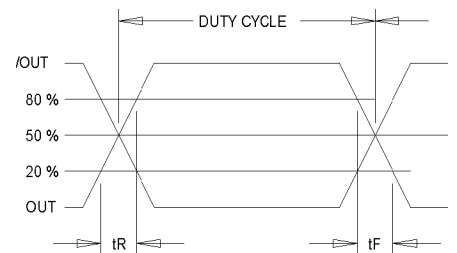

Output Waveform: LVDS/CML/PECL

MtronPTI reserves the right to make changes to the product(s) and service(s) described herein without notice. No liability is assumed as a result of their use or application.

Please see [www.mtronpti.com](http://www.mtronpti.com) for our complete offering and detailed datasheets. Contact us for your application specific requirements: MtronPTI 1-800-762-8800.