

# 133 MHz Spread Spectrum Clock Synthesizer/Driver with AGP, USB, and DRCG Support

Features	Benefits
<ul style="list-style-type: none"> <li>• <b>Mixed 2.5V and 3.3V Operation</b></li> <li>• <b>Compliant to Intel® CK133 (CY2210-3) &amp; CK133W (CY2210-2) synthesizer and driver specification</b></li> </ul>	Usable with Pentium® II and Pentium® III processors
<ul style="list-style-type: none"> <li>• <b>Multiple output clocks at different frequencies</b> <ul style="list-style-type: none"> <li>— Four CPU clocks, up to 133 MHz</li> <li>— Eight synchronous PCI clocks, 1 free-running</li> <li>— Two CPU/2 clocks, at one-half the CPU frequency</li> <li>— Four AGP clocks at 66 MHz</li> <li>— Three synchronous APIC clocks, at 16.67 MHz</li> <li>— One USB clock at 48 MHz</li> <li>— Two reference clocks at 14.318 MHz</li> </ul> </li> </ul>	Single-chip main motherboard clock generator <ul style="list-style-type: none"> <li>— Driven together, support 4 CPUs and a chipset</li> <li>— Support for 4 PCI slots and chipset</li> <li>— Drives up to two main memory clock generators, including DRCG (CPUCLK/2)</li> <li>— Support for multiple AGP slots</li> <li>— Support multiprocessing systems</li> <li>— Supports USB frequencies and I/O chip</li> </ul>
<ul style="list-style-type: none"> <li>• <b>Spread Spectrum clocking</b> <ul style="list-style-type: none"> <li>— 32.5-kHz modulation frequency @ 133 MHz</li> <li>— 33.1-kHz modulation frequency @ 100 MHz for CY2210-02/03</li> <li>— 33.4-kHz modulation frequency @ 100 MHz for CY2210-04</li> <li>— EPROM programmable percentage of spreading. Default is -0.6%, which is recommended by Intel</li> </ul> </li> </ul>	Enables reduction of EMI in some systems
• <b>Power-down features</b>	Supports mobile systems
• <b>Three Select inputs</b>	Supports up to eight CPU clock frequencies
• <b>Low-skew and low-jitter outputs</b>	Meets tight system timing requirements at high frequency
• <b>OE and Test Mode support</b>	Enables ATE and “bed of nails” testing
• <b>56-pin SSOP package</b>	Widely available, standard package enables lower cost

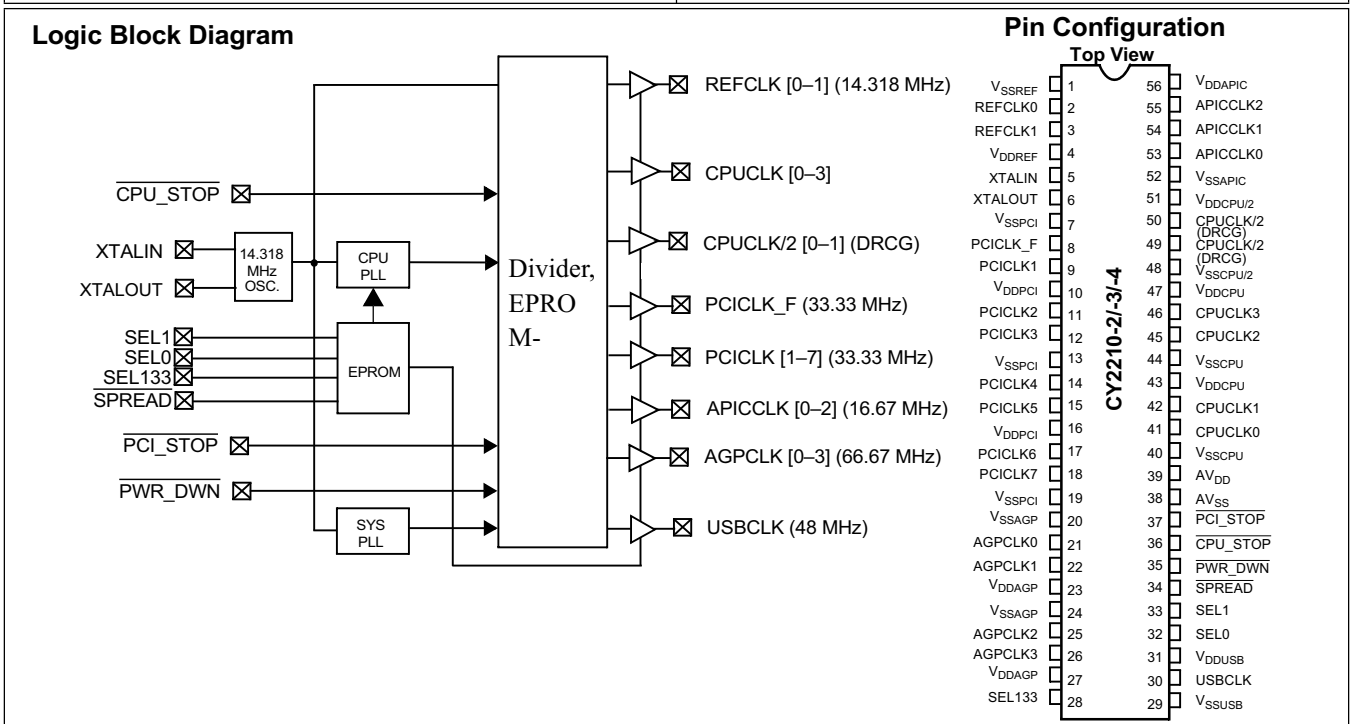

**Pin Summary**

Name	Pins	Description
V <sub>SSREF</sub>	1	3.3V Reference ground
V <sub>DDREF</sub>	4	3.3V Reference voltage supply
V <sub>SSPCI</sub>	7, 13, 19	3.3V PCI ground
V <sub>DDPCI</sub>	10, 16	3.3V PCI voltage supply
V <sub>SSAGP</sub>	20, 24	3.3V AGP ground
V <sub>DDAGP</sub>	23, 27	3.3V AGP voltage supply
V <sub>SSUSB</sub>	29	3.3V USB ground
V <sub>DDUSB</sub>	31	3.3V USB voltage supply
V <sub>SSCPU</sub>	40, 44	2.5V CPU ground
V <sub>DDCPU</sub>	43, 47	2.5V CPU voltage supply
V <sub>SSCPU/2</sub>	48	2.5V CPU/2 ground
V <sub>DDCPU/2</sub>	51	2.5V CPU/2 voltage supply
V <sub>SSAPIC</sub>	52	2.5V APIC ground
V <sub>DDAPIC</sub>	56	2.5V APIC voltage supply
AV <sub>SS</sub>	38	Analog ground to PLL and Core
AV <sub>DD</sub>	39	Analog voltage supply to PLL and Core
XTALIN <sup>[1]</sup>	5	Reference crystal input
XTALOUT <sup>[1]</sup>	6	Reference crystal feedback
CPUCLK [0–3]	41, 42, 45, 46	CPU clock outputs
PCICLK [1–7]	9, 11, 12, 14, 15, 17, 18	PCI clock outputs, synchronously running at 33.33 MHz
PCICLK_F	8	Free running PCI clock
CPUCLK/2	49, 50	CPU/2 clock outputs, drive memory clock generator
AGPCLK [0–3]	21, 22, 25, 26	AGP clock outputs, running at 66.66 MHz
APICCLK [0–2]	53, 54, 55	APIC clock outputs, running at 16.67 MHz
REFCLK [0–1]	2, 3	Reference clock outputs, 14.318 MHz
USBCLK	30	48-MHz USB clock output
CPU_STOP	36	Active LOW input, disables CPU and AGP clocks when asserted
PCI_STOP	37	Active LOW input, disables PCI clocks when asserted
PWR_DWN	35	Active LOW input, powers down part when asserted
SPREAD	34	Active LOW input, enables spread spectrum when asserted
SEL1	33	CPU frequency select input (See Function Table)
SEL0	32	CPU frequency select input (See Function Table)
SEL133	28	CPU frequency select input (See Function Table)

**Note:**

1. For best accuracy, use a parallel-resonant crystal, C<sub>LOAD</sub> = 18 pF. For crystals with different C<sub>LOAD</sub>, please refer to the application note, "Crystal Oscillator Topics."

**Function Table<sup>[2]</sup>**

SEL133	SEL1	SEL0	CPUCLK (MHz)	CPUCLK/2 (MHz)	AGPCLK (MHz)	PCICLK (MHz)	USBCLK (MHz)	REFCLK (MHz)	APICCLK (MHz)
0	0	0	Hi-Z	Hi-Z	Hi-Z	Hi-Z	Hi-Z	Hi-Z	Hi-Z
0	0	1	100.227 <sup>[3]</sup>	50.114 <sup>[3]</sup>	66.818 <sup>[3]</sup>	33.409 <sup>[3]</sup>	48.008 <sup>[3]</sup>	14.318 <sup>[3]</sup>	16.705 <sup>[3]</sup>
0	1	0	100	50	66.67	33.33	OFF	14.318	16.67
0	1	1	100	50	66.67	33.33	48	14.318	16.67
1	0	0	TCLK/2	TCLK/4	TCLK/4	TCLK/8	TCLK/2	TCLK	TCLK/16
1	0	1	N/A	N/A	N/A	N/A	N/A	N/A	N/A
1	1	0	133.33	66.67	66.67	33.33	OFF	14.318	16.67
1	1	1	133.33	66.67	66.67	33.33	48	14.318	16.67

**Actual Clock Frequency Values**

Clock Output	Target Frequency (MHz)			Actual Frequency (MHz)			PPM		
	-2	-3	-4	-2	-3	-4	-2	-3	-4
CPUCLK	100.0	100.0	100.0	99.126	99.126	100.227	-8740	-8740	+2714
CPUCLK	133.33	133.33	133.33	132.769	132.769	132.769	-4208	-4208	-4208
USBCLK	48.0	48.0	48.0	48.008	48.008	48.008	167	167	167

**Clock Enable Configuration**

$\overline{\text{CPU\_STOP}}$	$\overline{\text{PWR\_DWN}}$	$\overline{\text{PCI\_STOP}}$	CPUCLK	CPUCLK/2	AGP	PCI	PCI_F	REF APIC	OSC.	VCOs
X	0	X	LOW	LOW	LOW	LOW	LOW	LOW	OFF	OFF
0	1	0	LOW	ON	LOW	LOW	ON	ON	ON	ON
0	1	1	LOW	ON	LOW	ON	ON	ON	ON	ON
1	1	0	ON	ON	ON	LOW	ON	ON	ON	ON
1	1	1	ON	ON	ON	ON	ON	ON	ON	ON

**Clock Driver Impedances**

Buffer Name	V <sub>DD</sub> Range	Buffer Type	Impedance		
			Minimum $\Omega$	Typical $\Omega$	Maximum $\Omega$
CPU, CPU/2, APIC	2.375–2.625	Type 1	13.5	29	45
USB, REF	3.135–3.465	Type 3	20	40	60
PCI, AGP	3.135–3.465	Type 5	12	30	55

**Notes:**

- TCLK is a test clock driven in on the XTALIN input in test mode.
- Only CY2210-2 supports this option. In CY2210-3, this selection is defined as "N/A" or "Reserved".

**Maximum Ratings**

(Above which the useful life may be impaired. For user guidelines, not tested.)

Supply Voltage.....-0.5 to +7.0V

Input Voltage.....-0.5V to  $V_{DD}+0.5$

Storage Temperature (Non-Condensing) .....-65°C to +150°C

Junction Temperature..... +150°C

Package Power Dissipation..... 1W

Static Discharge Voltage  
(per MIL-STD-883, Method 3015) ..... >2000V

**Operating Conditions** Over which Electrical Parameters are Guaranteed

Parameter	Description	Min.	Max.	Unit
$V_{DDREF}, V_{DDPCI}, AV_{DD}, V_{DDAGP}, V_{DDUSB}$	3.3V Supply Voltages	3.135	3.465	V
$V_{DDCPU}, V_{DDCPU/2}$	CPU and CPU/2 Supply Voltage	2.375	2.625	V
$V_{DDAPIC}$	APIC Supply Voltage	2.375	2.625	V
$T_A$	Operating Temperature, Ambient	0	70	°C
$C_L$	Max. Capacitive Load on CPUCLK, CPUCLK/2, USBCLK, REF, APIC PCICLK, AGP		20 30	pF
$f_{(REF)}$	Reference Frequency, Oscillator Nominal Value	14.318	14.318	MHz
$t_{PU}$	Power-up time for all VDD's to reach minimum specified voltage (power ramps must be monotonic)	0.05	50	ms

**Electrical Characteristics** Over the Operating Range

Parameter	Description	Test Conditions	Min.	Max.	Unit
$V_{IH}$	High-level Input Voltage	Except Crystal Pads. Threshold voltage for crystal pads = $V_{DD}/2$	2.0		V
$V_{IL}$	Low-level Input Voltage	Except Crystal Pads		0.8	V
$V_{OH}$	High-level Output Voltage <sup>[4]</sup>	CPU, CPU/2, APIC $I_{OH} = -1$ mA	2.0		V
		USB, REF, PCI, AGP $I_{OH} = -1$ mA	2.4		
$V_{OL}$	Low-level Output Voltage <sup>[4]</sup>	CPU, CPU/2, APIC $I_{OL} = 1$ mA		0.4	V
		USB, REF, PCI, AGP $I_{OL} = 1$ mA		0.4	
$I_{IH}$	Input High Current	$0 \leq V_{IN} \leq V_{DD}$		10	$\mu$ A
$I_{IL}$	Input Low Current	$0 \leq V_{IN} \leq V_{DD}$		10	$\mu$ A
$I_{OH}$	High-level Output Current <sup>[4]</sup>	CPU, CPU/2 $V_{OH} = 2.0$ V	-16	-60	mA
		APIC $V_{OH} = 2.0$ V	-20	-72	
		USB, REF $V_{OH} = 2.4$ V	-15	-51	
		AGP, PCI $V_{OH} = 2.4$ V	-30	-100	
$I_{OL}$	Low-level Output Current <sup>[4]</sup>	CPU, CPU/2 $V_{OL} = 0.4$ V	19	49	mA
		APIC $V_{OL} = 0.4$ V	25	58	
		USB, REF $V_{OL} = 0.4$ V	10	24	
		AGP, PCI $V_{OL} = 0.4$ V	20	49	
$I_{OZ}$	Output Leakage Current	Three-state		10	$\mu$ A
$I_{DD2}$	2.5V Power Supply Current	$AV_{DD}/V_{DD33} = 3.465$ V, $V_{DD25} = 2.625$ V, $F_{CPU} = 133$ MHz		90	mA
$I_{DD3}$	3.3V Power Supply Current	$AV_{DD}/V_{DD33} = 3.465$ V, $V_{DD25} = 2.625$ V, $F_{CPU} = 133$ MHz		160	mA
$I_{DDPD2}$	2.5V Shutdown Current	$AV_{DD}/V_{DD33} = 3.465$ V, $V_{DD25} = 2.625$ V		100	$\mu$ A
$I_{DDPD3}$	3.3V Shutdown Current	$AV_{DD}/V_{DDQ3} = 3.465$ V, $V_{DD25} = 2.625$ V		200	$\mu$ A

**Note:**

4. Parameter is guaranteed by design and characterization. Not 100% tested in production.

**Switching Characteristics<sup>[4, 5]</sup> Over the Operating Range**

Parameter	Output	Description	Test Conditions	Min.	Max.	Unit
t <sub>1</sub>	All	Output Duty Cycle <sup>[6]</sup>	t <sub>1A</sub> /t <sub>1B</sub>	45	55	%
t <sub>2</sub>	CPU, CPU/2, APIC	Rising Edge Rate	Between 0.4V and 2.0V	1.0	4.0	V/ns
t <sub>2</sub>	USB, REF	Rising Edge Rate	Between 0.4V and 2.4V	0.5	2.0	V/ns
t <sub>2</sub>	PCI, AGP	Rising Edge Rate	Between 0.4V and 2.4V	1.0	4.0	V/ns
t <sub>3</sub>	CPU, CPU/2, APIC	Falling Edge Rate	Between 2.0V and 0.4V	1.0	4.0	V/ns
t <sub>3</sub>	USB, REF	Falling Edge Rate	Between 2.4V and 0.4V	0.5	2.0	V/ns
t <sub>3</sub>	PCI, AGP	Falling Edge Rate	Between 2.4V and 0.4V	1.0	4.0	V/ns
t <sub>6</sub>	CPU	CPU-CPU Skew	Measured at 1.25V		175	ps
t <sub>7</sub>	CPU/2	CPU/2-CPU/2 Skew	Measured at 1.25V		175	ps
t <sub>8</sub>	APIC	APIC-APIC Skew	Measured at 1.25V		250	ps
t <sub>9</sub>	AGP	AGP-AGP Skew	Measured at 1.5V		250	ps
t <sub>10</sub>	PCI	PCI-PCI Skew	Measured at 1.5V		500	ps
t <sub>11</sub>	CPU, AGP	CPU-AGP Clock Skew	CPU leads. Measured at 1.25V for 2.5V clocks and 1.5V for 3.3V clocks	0	1.5	ns
t <sub>12</sub>	AGP, PCI	AGP-PCI Clock Skew	AGP leads. Measured at 1.5V	1.5	4.0	ns
t <sub>13</sub>	CPU, APIC	CPU-APIC Clock Skew	CPU leads. Measured at 1.25V	1.5	4	ns
t <sub>14</sub>	CPU, PCI	CPU-PCI Clock Skew	CPU leads. Measured at 1.25V clocks and 1.5V for 3.3V clocks	1.5	4	ns
	CPU	Cycle-Cycle Clock Jitter	With all outputs running (CY2210-2)		150	ps
	CPU	Cycle-Cycle Clock Jitter	With all outputs running (CY2210-3/-4)		250	ps
	CPU	Cycle-Cycle Clock Jitter	With the USB output turned off (CY2210-3/-4)		200	ps
	CPU/2	Cycle-Cycle Clock Jitter			250	ps
	APIC	Cycle-Cycle Clock Jitter			500	ps
	USB	Cycle-Cycle Clock Jitter			500	ps
	AGP	Cycle-Cycle Clock Jitter			500	ps
	REF	Cycle-Cycle Clock Jitter			1000	ps
	CPU, PCI	Settle Time	CPU and PCI clock stabilization from power-up		3	ms

**Notes:**

5. All parameters specified with loaded outputs.

6. Duty cycle is measured at 1.5V when V<sub>DD</sub> = 3.3V. When V<sub>DD</sub> = 2.5V, duty cycle is measured at 1.25V.

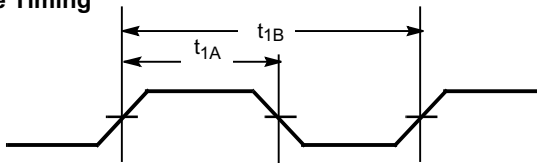
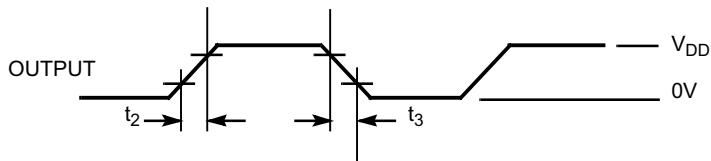
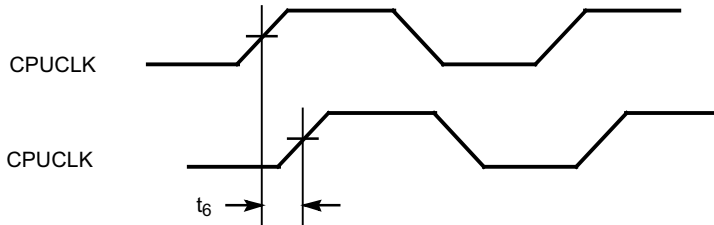
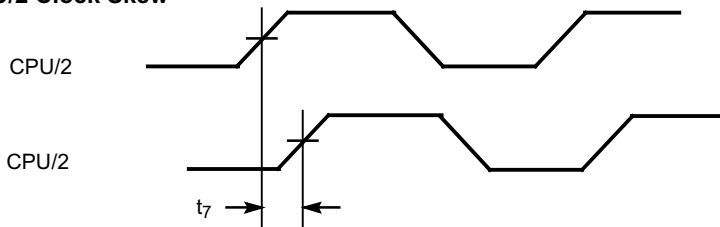
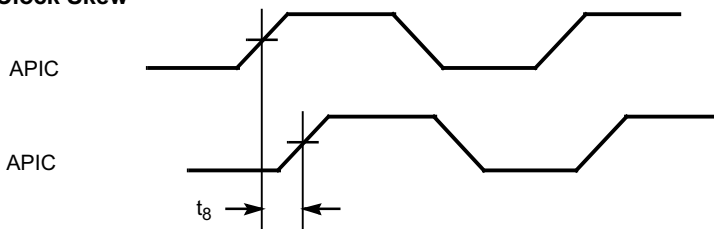
**Switching Waveforms**
**Duty Cycle Timing**

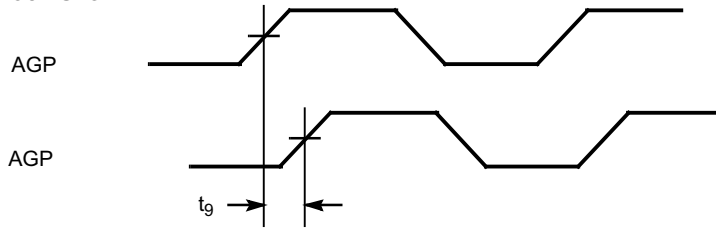
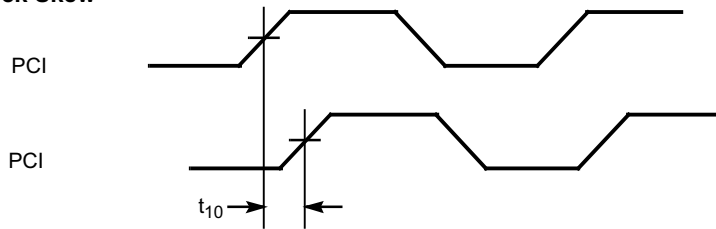
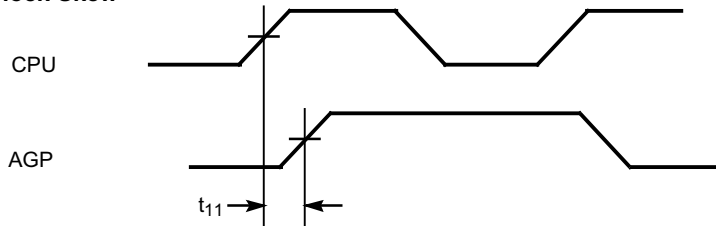
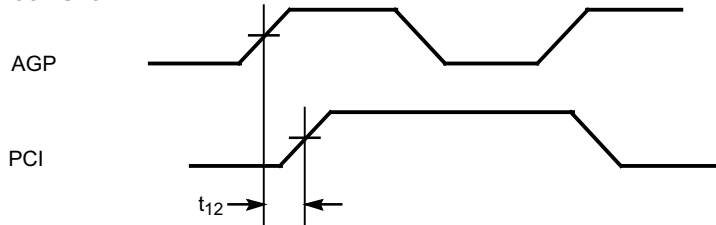
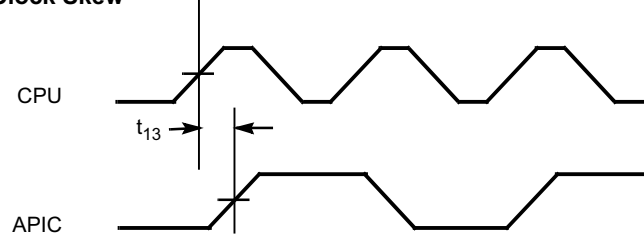
**All Outputs Rise/Fall Time**

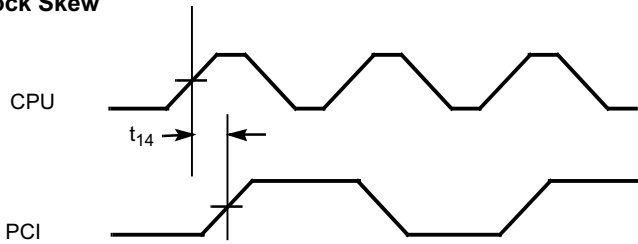
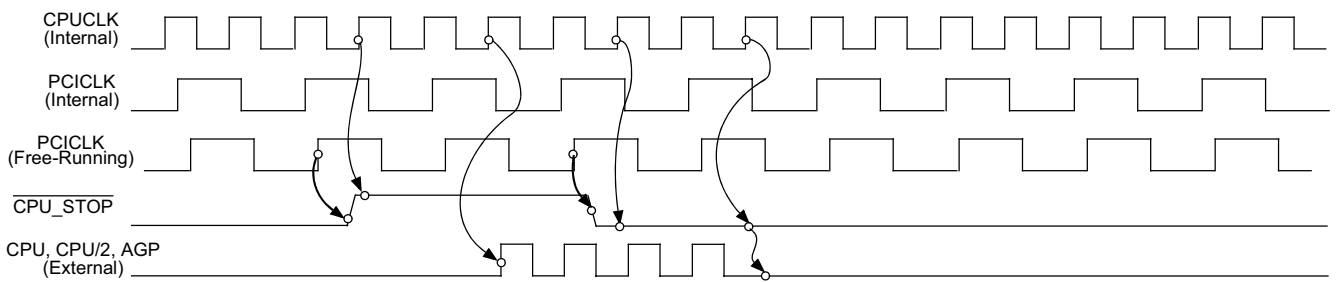
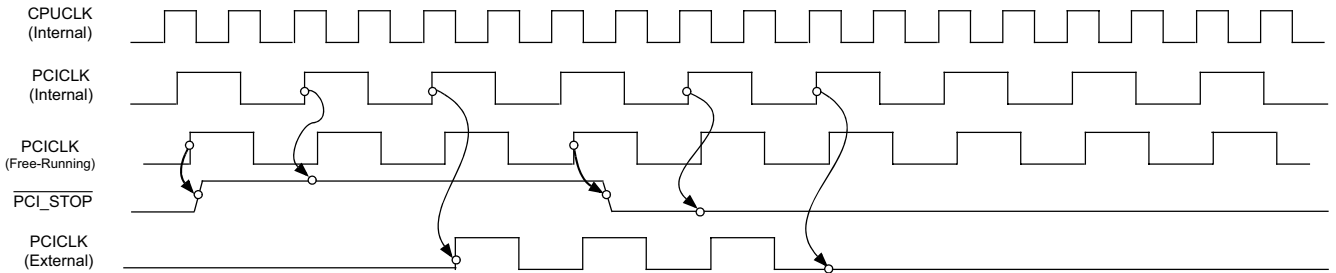
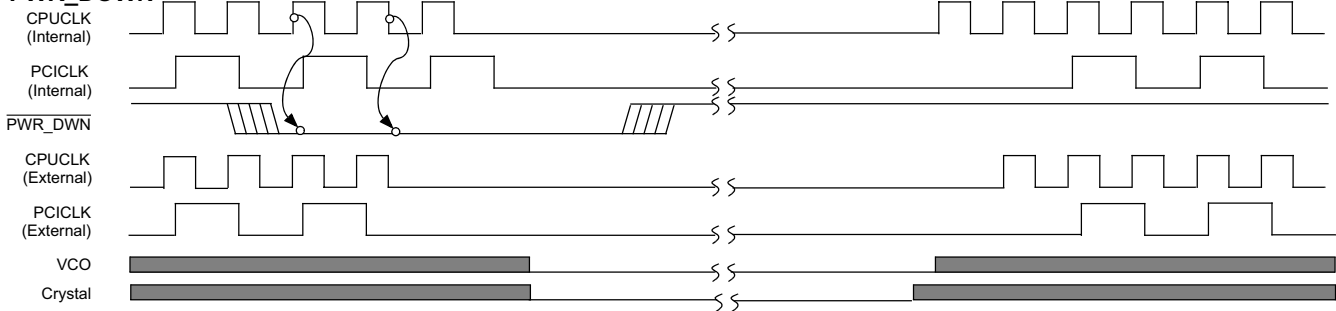
**CPU-CPU Clock Skew**

**CPU/2 - CPU/2 Clock Skew**

**APIC-APIC Clock Skew**

**Switching Waveforms (continued)**
**AGP-AGP Clock Skew**

**PCI-PCI Clock Skew**

**CPU-AGP Clock Skew**

**AGP - PCI Clock Skew**

**CPU-APIC Clock Skew**

**Switching Waveforms (continued)**
**CPU-PCI Clock Skew**

**CPU\_STOP Timing [7, 8]**

**PCI\_STOP**

**PWR\_DOWN**

Shaded section on the VCO and Crystal waveforms indicates that the VCO and crystal oscillator are active, and there is a valid clock.

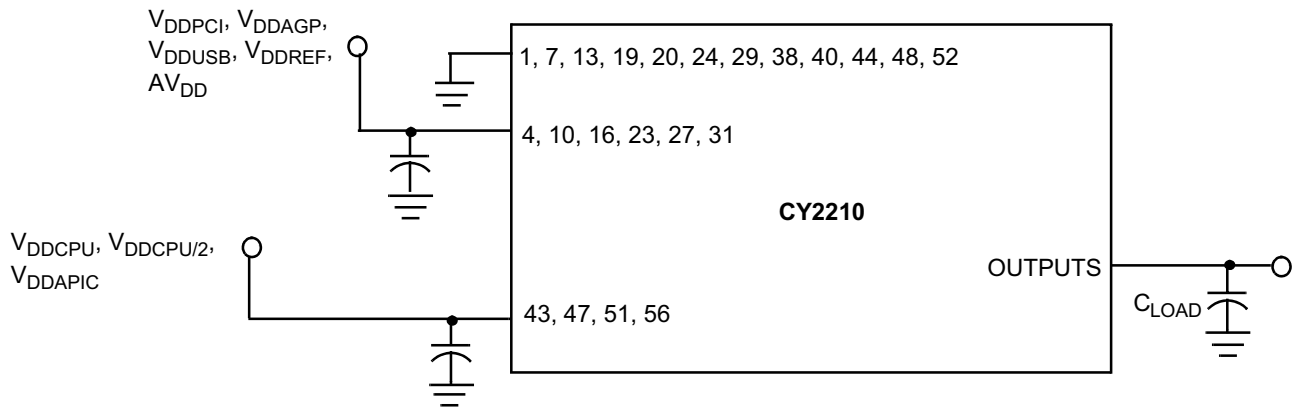
**Notes:**

7. CPUCLK on and CPUCLK off latency is 2 or 3 CPUCLK cycles.
8. CPU\_STOP may be applied asynchronously. It is synchronized internally.



**Test Circuit**

Note that Each supply pin must have an individual decoupling capacitor.

Note that All capacitors must be placed as close to the pins as is physically possible.

**Ordering Information**

Ordering Code	Package Name	Package Type	Operating Range
CY2210PVC-2/-3/-4	O56	56-Pin SSOP	Commercial

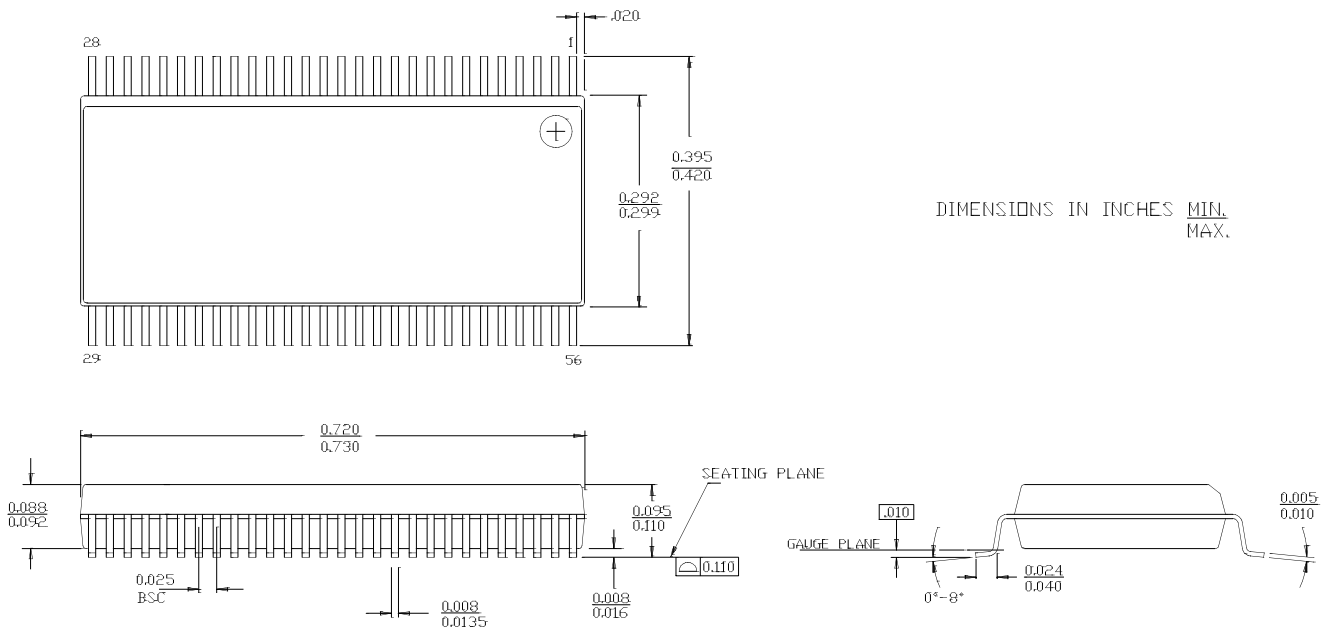
**Package Diagram**
**56-Lead Shrink Small Outline Package O56**

While SLI has reviewed all information herein for accuracy and reliability, Spectra Linear Inc. assumes no responsibility for the use of any circuitry or for the infringement of any patents or other rights of third parties which would result from each use. This product is intended for use in normal commercial applications and is not warranted nor is it intended for use in life support, critical medical instruments, or any other application requiring extended temperature range, high reliability, or any other extraordinary environmental requirements unless pursuant to additional processing by Spectra Linear Inc., and expressed written agreement by Spectra Linear Inc. Spectra Linear Inc. reserves the right to change any circuitry or specification without notice.