

WHITE LED STEP-UP CONVERTER**AP3029****General Description**

The AP3029 is an inductor-based DC/DC converter designed to drive up to six white LEDs in series or 2 rows of LEDs with 5 for each in parallel for backlight. Only one feedback resistor is needed to control the LED current and obtain required brightness.

A constant frequency 1.2MHz PWM control scheme is employed in this IC, which means tiny external components can be used. In fact, 1mm tall inductor and 0.22 μ F output capacitor for a typical application is sufficient. Additionally, the schottky diode in boost circuit is integrated on this chip. AP3029 also provides a disable pin to ease its use for different systems.

The over output voltage protection is equipped in AP3029. When any LED is broken or in other abnormal conditions, the output voltage will be clamped to 27V.

The AP3029 is available in standard SOT-23-6 and TSOT-23-6 packages.

Features

- Inherently Uniform LED Current
- High Efficiency up to 83.5%
- No Need for External Schottky Diode
- Over Output Voltage Protection
- Drives 2 to 6 LEDs in Series or 2 Rows of LEDs with 5 for Each in Parallel
- Fast 1.2MHz Switching Frequency
- Uses Tiny 1mm Tall Inductor
- Requires Only 0.22 μ F Output Capacitor

Applications

- Cellular Phones
- Digital Cameras
- LCD modules
- GPS Receivers
- PDAs, Handheld Computers

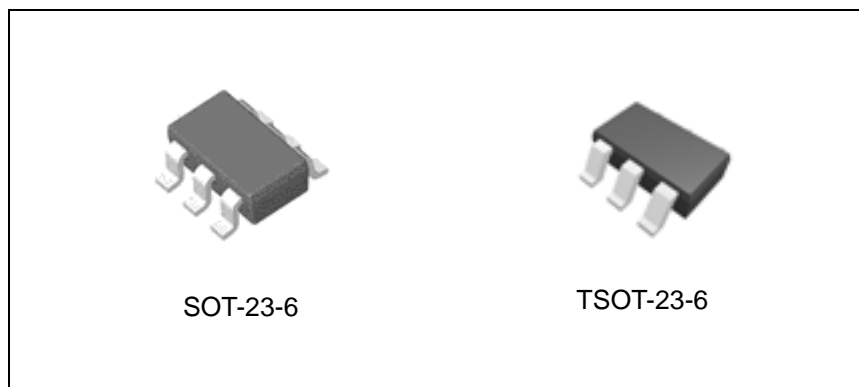

Figure 1. Package Type of AP3029

WHITE LED STEP-UP CONVERTER
AP3029
Pin Configuration

Figure 2. Pin Configuration of AP3029 (Top View)

Pin Description

Pin Number	Pin Name	Function
1	SW	Switch Pin. Connect external inductor
2	GND	Ground Pin
3	FB	Voltage Feedback. Reference voltage is 200mV
4	CTRL	Shutdown and Dimming Pin. Connect to 1.8V or higher to enable device; Connect to 50mV or less to disable device; Connect to a voltage between 1.8V and 50mV to achieve linear dimming
5	V _{OUT}	Output Pin. Connected to the cathode of internal schottky diode
6	V _{IN}	Input Supply Pin. Must be locally bypassed

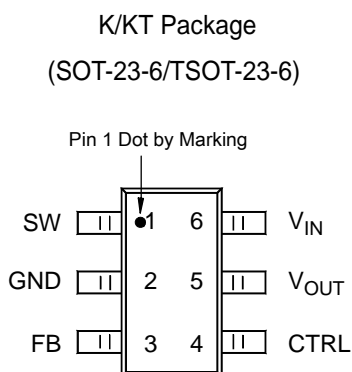

WHITE LED STEP-UP CONVERTER

AP3029

Functional Block Diagram

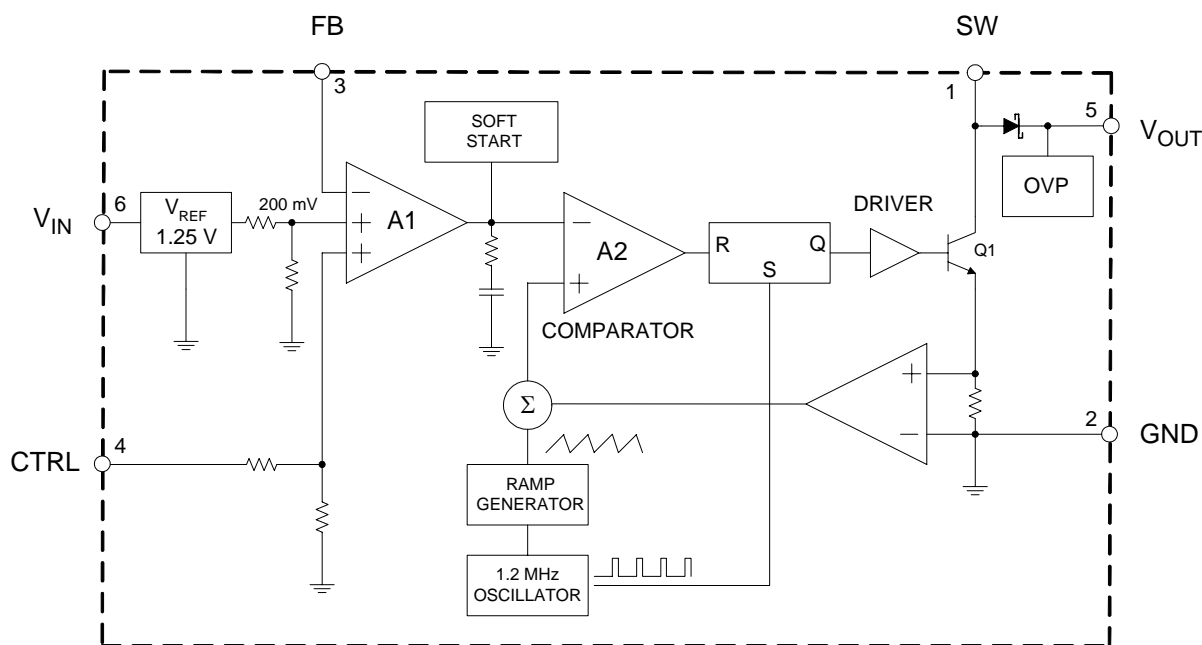
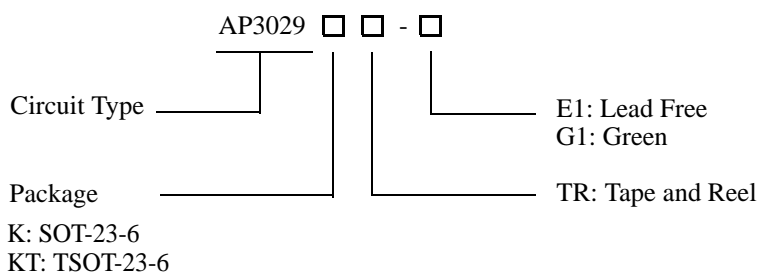

Figure 3. Functional Block Diagram of AP3029

Ordering Information



Package	Temperature Range	Part Number		Marking ID		Packing Type
		Lead Free	Green	Lead Free	Green	
SOT-23-6	-40 to 85°C	AP3029KTR-E1	AP3029KTR-G1	E8S	G8S	Tape & Reel
TSOT-23-6	-40 to 85°C	AP3029KTTR-E1	AP3029KTTR-G1	S9F	L9F	Tape & Reel

BCD Semiconductor's Pb-free products, as designated with "E1" suffix in the part number, are RoHS compliant. Products with "G1" suffix are available in green packages.

**WHITE LED STEP-UP CONVERTER****AP3029****Absolute Maximum Ratings (Note 1)**

Parameter	Symbol	Value	Unit
Input Voltage	V_{IN}	20	V
SW Voltage		27	V
FB Voltage		20	V
CTRL Voltage		20	V
Thermal Resistance (Junction to Atmosphere, no Heat sink)	$R_{\theta JA}$	265	$^{\circ}C/W$
Operating Junction Temperature		150	$^{\circ}C$
Storage Temperature Range	T_{STG}	-65 to 150	$^{\circ}C$
Lead Temperature (Soldering, 10sec)	T_{LEAD}	260	$^{\circ}C$
ESD (Machine Model)		250	V
ESD (Human Body Model)		2000	V

Note 1: Stresses greater than those listed under "Absolute Maximum Ratings" may cause permanent damage to the device. These are stress ratings only, and functional operation of the device at these or any other conditions beyond those indicated under "Recommended Operating Conditions" is not implied. Exposure to "Absolute Maximum Ratings" for extended periods may affect device reliability.

Recommended Operating Conditions

Parameter	Symbol	Min	Max	Unit
Operating Temperature Range	T_{OP}	-40	85	$^{\circ}C$
Input Voltage	V_{IN}	2.5	16	V
CTRL Voltage	V_{CTRL}		16	V

**WHITE LED STEP-UP CONVERTER****AP3029****Electrical Characteristics**(V_{IN}=3V, V_{CTRL}=3V, T_A=25°C, unless otherwise specified.)

Parameter	Symbol	Conditions	Min	Typ	Max	Unit
Minimum Operating Voltage	V _{IN(min)}		2.5			V
Maximum Operating Voltage	V _{IN(max)}				16	
Feedback Voltage	V _{FB}	I _{OUT} =20mA, 4 LEDs, T _A =-40°C to 85°C	188	200	212	mV
FB Pin Bias Current	I _{FB}			35	100	nA
Supply Current	I _{CC}	V _{FB} =V _{IN} , No Switching	1.5	2.5	3.2	mA
Shutdown Quiescent Current	I _Q	V _{CTRL} =0V	2.0	3.2	5.0	μA
Switching Frequency	f		0.9	1.2	1.5	MHz
Maximum Duty Cycle	D _{MAX}		90	93		%
Switch Current Limit (Note 2)	I _{LIMIT}	T _A =25°C, D=40%		550		mA
		T _A =25°C, D=80%		550		
Switch V _{CE} Saturation Voltage	V _{CESAT}	I _{SW} =250mA		360		mV
Switch Leakage Current		V _{SW} =5V		0.01	5	μA
CTRL Pin Voltage	V _{CTRL}	High	1.8			V
		Low			0.05	
CTRL Pin Bias Current	I _{CTRL}		40	55	72	μA
		T _A =85°C		50		
		T _A =-40°C		75		
Schottky Forward Drop	V _{DROP}	I _D =150mA		0.7		V
Schottky Leakage Current		Reverse Voltage V _R =23V		0.1	4	μA
		Reverse Voltage V _R =27V			150	
Soft Start Time	t			300		μS

Note 2: The Switch Current Limit is related to Duty Cycle. Please refer to Figure 16 for detail.



WHITE LED STEP-UP CONVERTER

AP3029

Typical Performance Characteristics

(V_F of WLED is 3.45V @ $I_F=20mA$, unless otherwise noted)

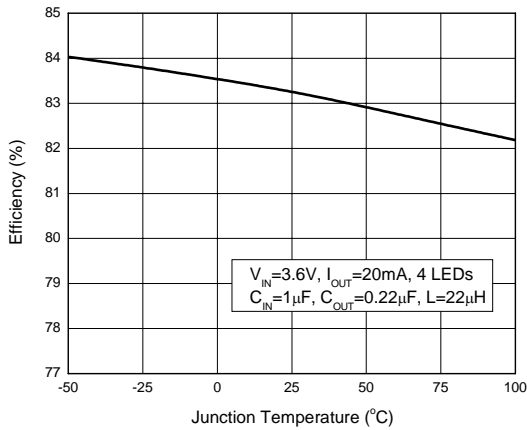

Figure 4. Efficiency vs. Junction Temperature

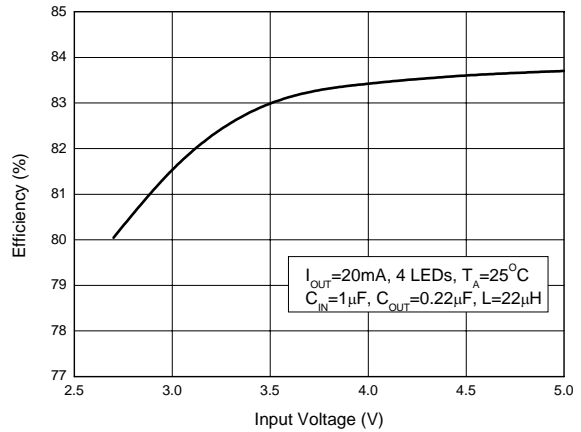

Figure 5. Efficiency vs. Input Voltage

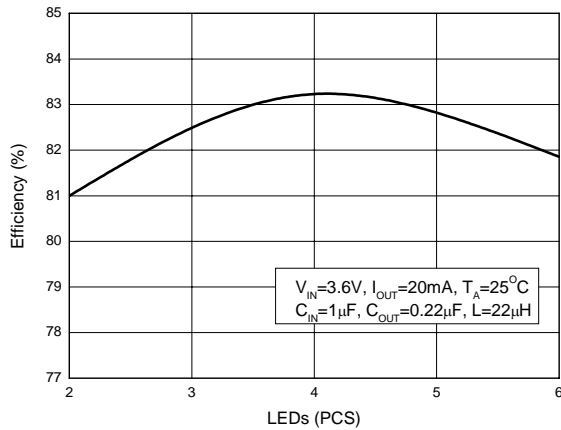

Figure 6. Efficiency vs. LED's Number

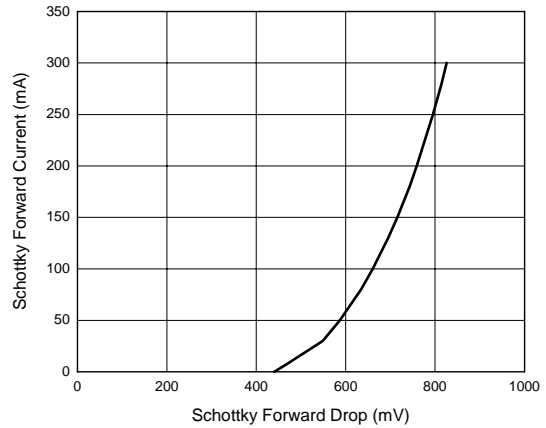

Figure 7. Schottky Forward Current vs. Schottky Forward Drop



WHITE LED STEP-UP CONVERTER

AP3029

Typical Performance Characteristics (Continued)

(V_F of WLED is 3.45V @ $I_F=20\text{mA}$, unless otherwise noted)

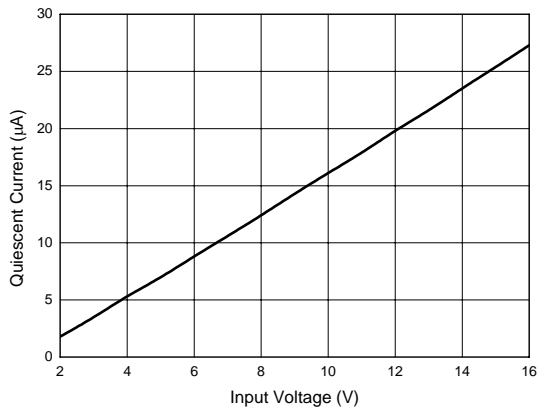

Figure 8. Shutdown Quiescent Current vs. Input Voltage

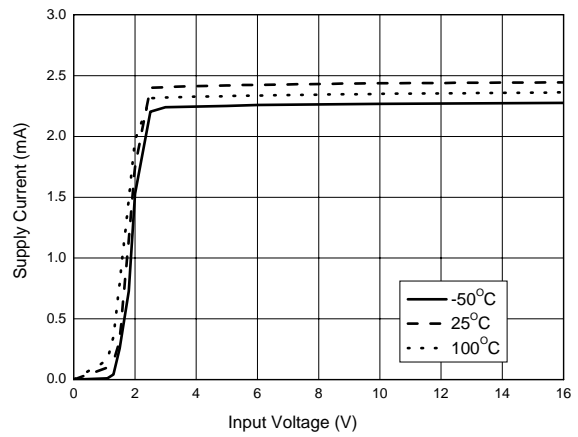

Figure 9. Supply Current vs. Input Voltage

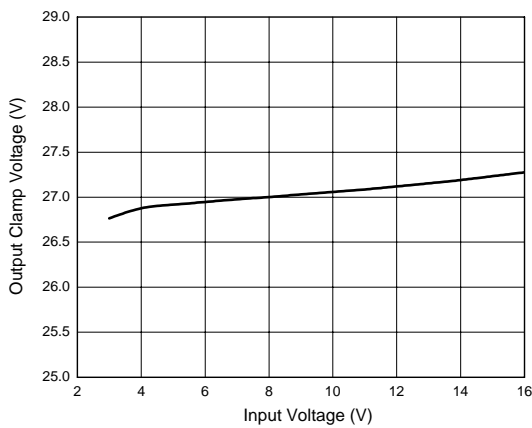

Figure 10. Output Clamp Voltage vs. Input Voltage

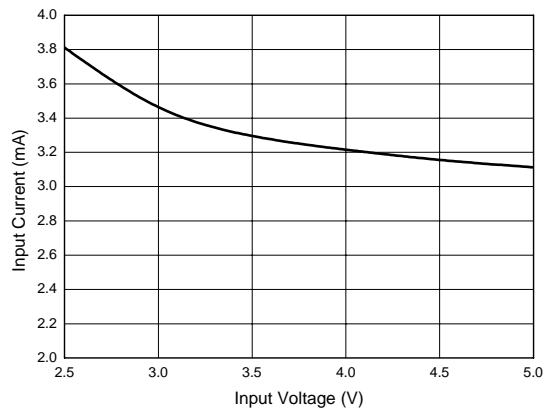

Figure 11. Input Current in Output Open Circuit vs. Input Voltage



WHITE LED STEP-UP CONVERTER

AP3029

Typical Performance Characteristics (Continued)

(V_F of WLED is 3.45V @ $I_F=20\text{mA}$, unless otherwise noted)

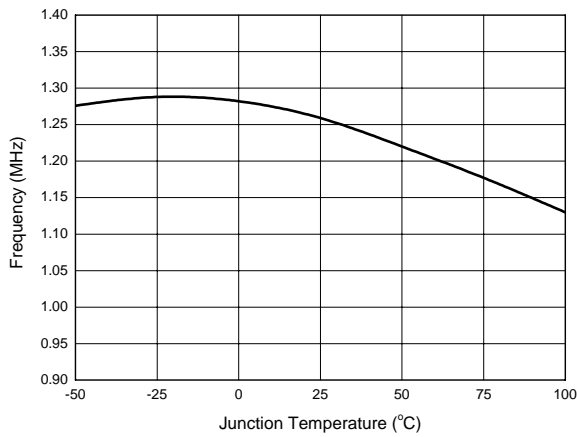

Figure 12. Switching Frequency vs. Junction Temperature

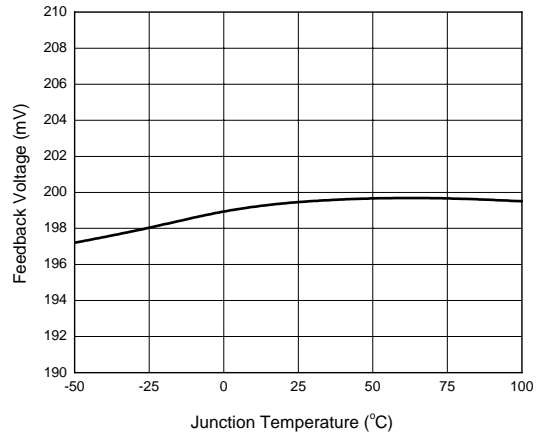

Figure 13. Feedback Voltage vs. Junction Temperature

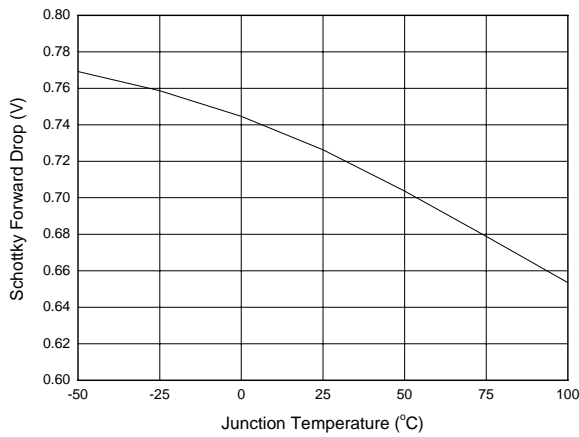

Figure 14. Schottky Forward Drop vs. Junction Temperature

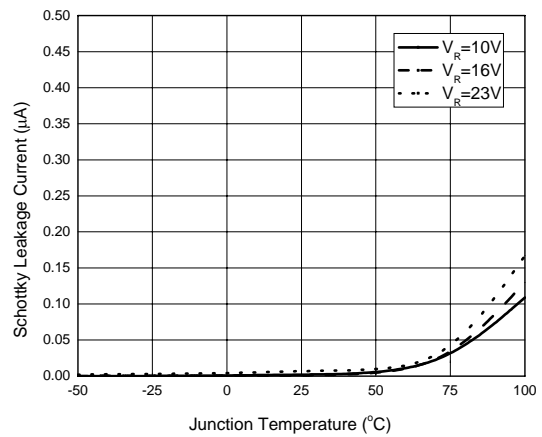

Figure 15. Schottky Leakage Current vs. Junction Temperature



WHITE LED STEP-UP CONVERTER

AP3029

Typical Performance Characteristics (Continued)

(V_F of WLED is 3.45V @ $I_F=20\text{mA}$, unless otherwise noted)

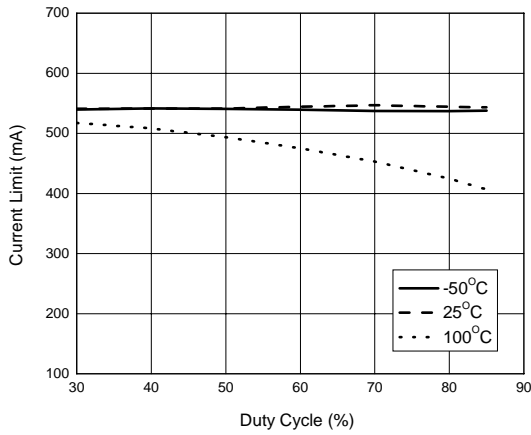

Figure 16. Switch Current Limit vs. Duty Cycle

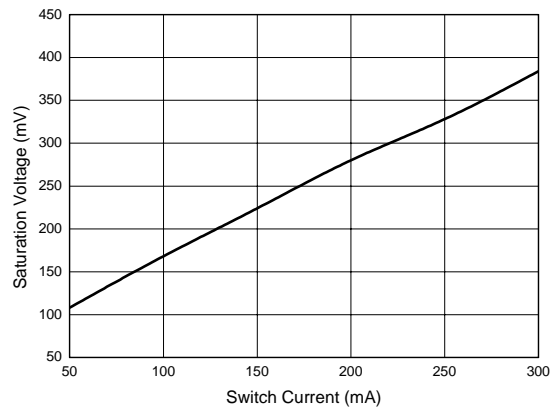

Figure 17. Switch Saturation Voltage vs. Switch Current

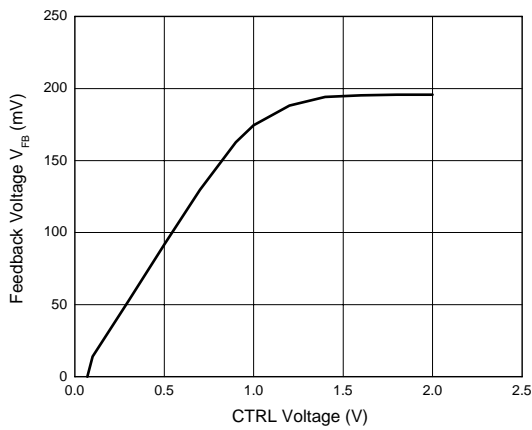

Figure 18. Feedback Voltage vs. CTRL Pin Voltage

WHITE LED STEP-UP CONVERTER
AP3029
Application Information
Operation

The AP3029 is a boost DC-DC converter which uses a constant frequency, current mode control scheme to provide excellent line and load regulation. Operation can be best understood by referring to the Figure 3.

At the start of each oscillator cycle, the SR latch is set and switch Q1 turns on. The switch current will increase linearly. The voltage on sense resistor is proportional to the switch current. The output of the current sense amplifier is added to a stabilizing ramp and the result is fed into the non-inversion input of the PWM comparator A2. When this voltage exceeds the output voltage level of the error amplifier A1, the SR latch is reset and the switch is turned off.

It is clear that the voltage level at inversion input of A2 sets the peak current level to keep the output in regulation. This voltage level is the output signal of error amplifier A1, and is the amplified signal of the voltage difference between feedback voltage and reference voltage of 200mV. So, a constant output current can be provided by this operation mode.

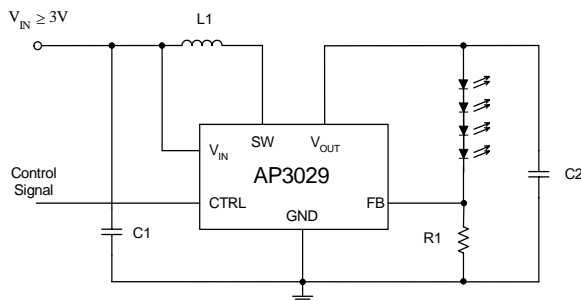

Figure 19. Typical Application circuit to Decide R1

LED Current Control

Refer to Figure 19, the LED current is controlled by the feedback resistor R1. LEDs' current accuracy is determined by the regulator's feedback threshold accuracy and is independent of the LED's forward voltage variation. So the precise resistors are preferred. The resistance of R1 is in inverse proportion to the LED current since the feedback reference is fixed at 200mV. The relation for R1 and LED current can be expressed as below:

$$R_1 = \frac{200mV}{I_{LED}}$$

Over Voltage Protection

The AP3029 has an internal open-circuit protection circuit. When the LEDs are disconnected from circuit or fail open, the output voltage is clamped at 27V. The AP3029 will switch at a low frequency, and minimize input current.

Soft Start

The AP3029 has an internal soft start circuit to limit the inrush current during startup. The time of startup is controlled by internal soft start capacitor. Please refer to Figure 20.

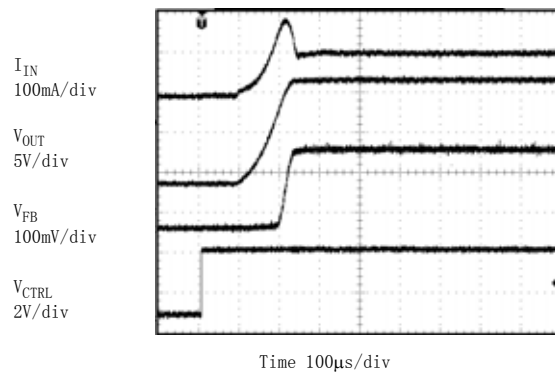
 Figure 20. Soft Start Waveform
 $V_{IN}=3.6V$, 5 LEDs, $I_{LED}=20mA$
Dimming Control

Two typical types of dimming control circuit are present as below. First, controlling CTRL Pin voltage to change operation state is a good choice. Second, changing the feedback voltage to get appropriate duty and luminous intensity is also useful.

(1). Adding a Control Signal to CTRL Pin

There are three methods to control CTRL pin signal

First, adding a PWM Signal to CTRL pin directly. The AP3029 is turned on or off by the PWN signal when it is applied on the CTRL pin. The typical frequency of

WHITE LED STEP-UP CONVERTER
AP3029
Application Information (Continued)

this PWM signal can be up to 2KHz. Please refer to Figure 21.

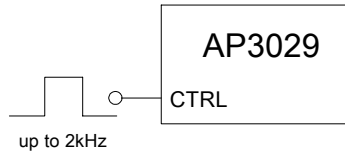

Figure 21. Dimming Control Using a PWM Signal in CTRL Pin

Secondly, adding a constant DC voltage through a resistor divider to CTRL pin can control the dimming. The FB voltage is indirectly adjusted when the CTRL pin voltage is between 50mV to 1.8V, which can be used as dimming control. Please refer Figure 22.

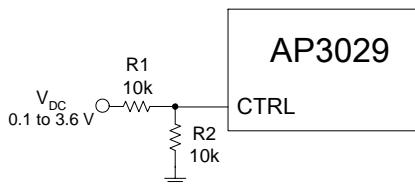

Figure 22. Dimming Control Using a DC Voltage in CTRL Pin

Thirdly, using a filtered PWM signal adding to CTRL pin can achieve dimming control. The filtered PWM signal can be considered as an adjustable DC voltage. It will change the FB voltage indirectly and achieve dimming control. The circuit is shown in Figure 23.

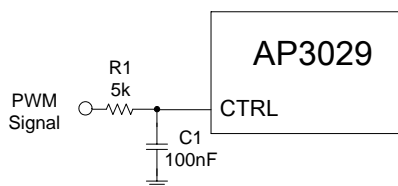

Figure 23. Dimming Control Using a Filtered PWM Signal Voltage in CTRL Pin

First, adding a constant DC voltage through a resistor divider to FB pin can control the dimming. Changing the DC voltage or resistor between the FB Pin and the DC voltage can get appropriate luminous intensity. Comparing with all kinds of PWM signal control, this method features a stable output voltage and LEDs current. Please refer Figure 24.

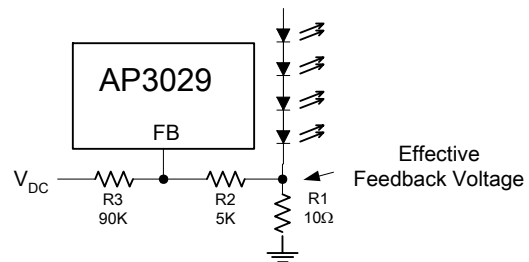

Figure 24. Dimming Control Using DC Voltage

Second, using a filtered PWM signal can do it. The filtered PWM signal can be considered as a varying and adjustable DC voltage.

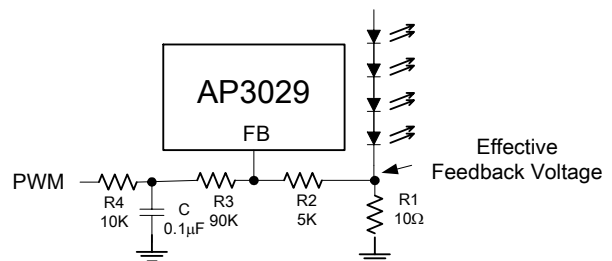

Figure 25. Dimming Control Using a Filtered PWM Voltage

Third, using a logic signal to change the feedback voltage. For example, the FB pin is connected to the GND through a mosFET and a resistor. And this mosFET is controlled a logic signal. The luminous intensity of LEDs will be changed when the mosFET turns on or off.

(2). Changing the Effective Feedback Voltage

There are three methods to change the effective feedback voltage.

Application Information (Continued)

Figure 26. Dimming Control
Using Logic Signal

Typical Application

C: X5R or X7R Dielectric
L: SUMIDA CDRH5D28R-100NC or Equivalent
This circuit can work in full temperature

A. Four White LEDs Driver

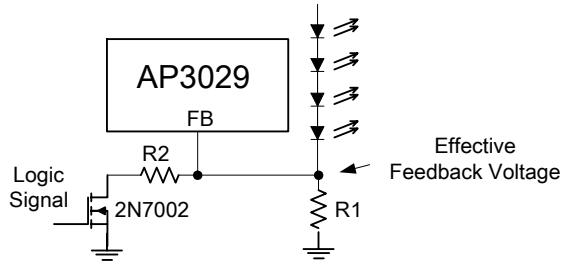
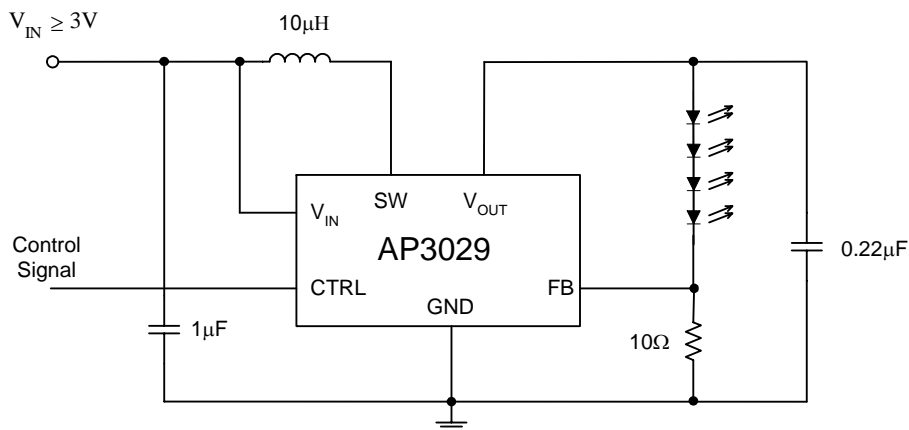
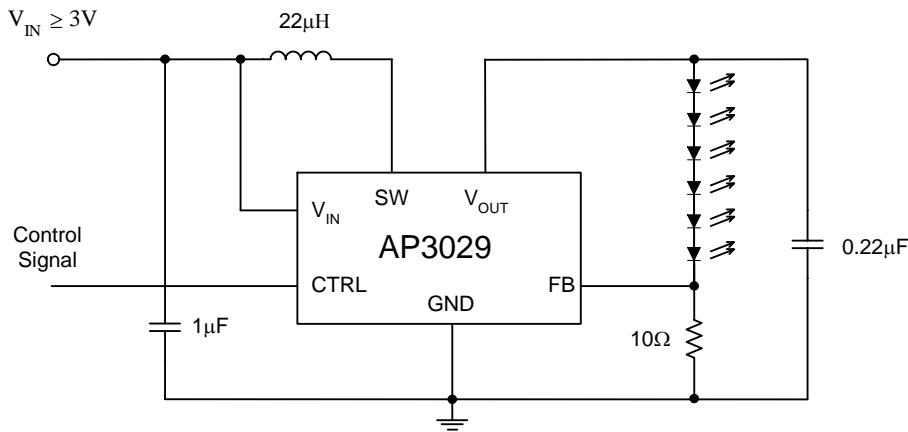
WHITE LED STEP-UP CONVERTER
AP3029
Typical Application (Continued)

C: X5R or X7R Dielectric
 L: SUMIDA CDRH5D28R-220NC or Equivalent
 This circuit can work in full temperature

B. Six White LEDs Driver

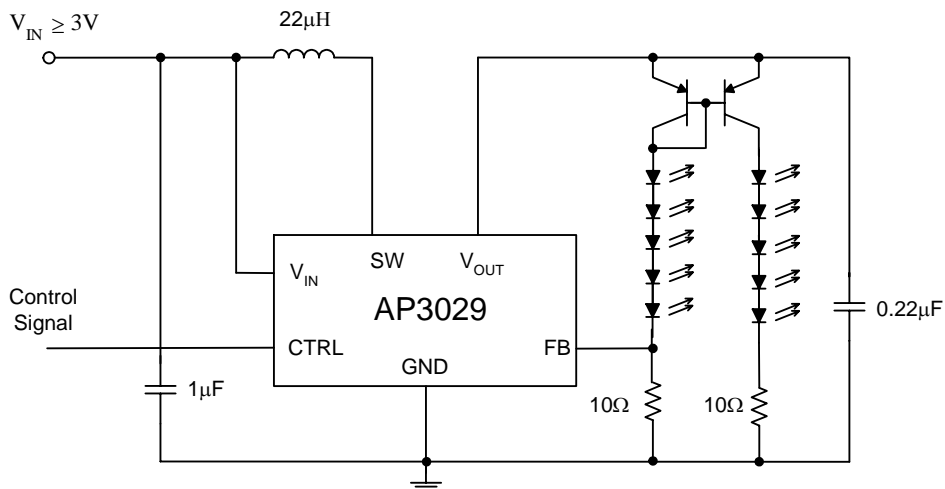

C: X5R or X7R Dielectric
 L: SUMIDA CDRH5D28R-220NC or Equivalent
 Two transistors are recommended to use Dual Matched transistor pairs
 This circuit can work in full temperature

C. Ten White LEDs Driver

Figure 27. Typical Application of LED Drivers



WHITE LED STEP-UP CONVERTER

AP3029

Mechanical Dimensions

SOT-23-6

Unit: mm(inch)

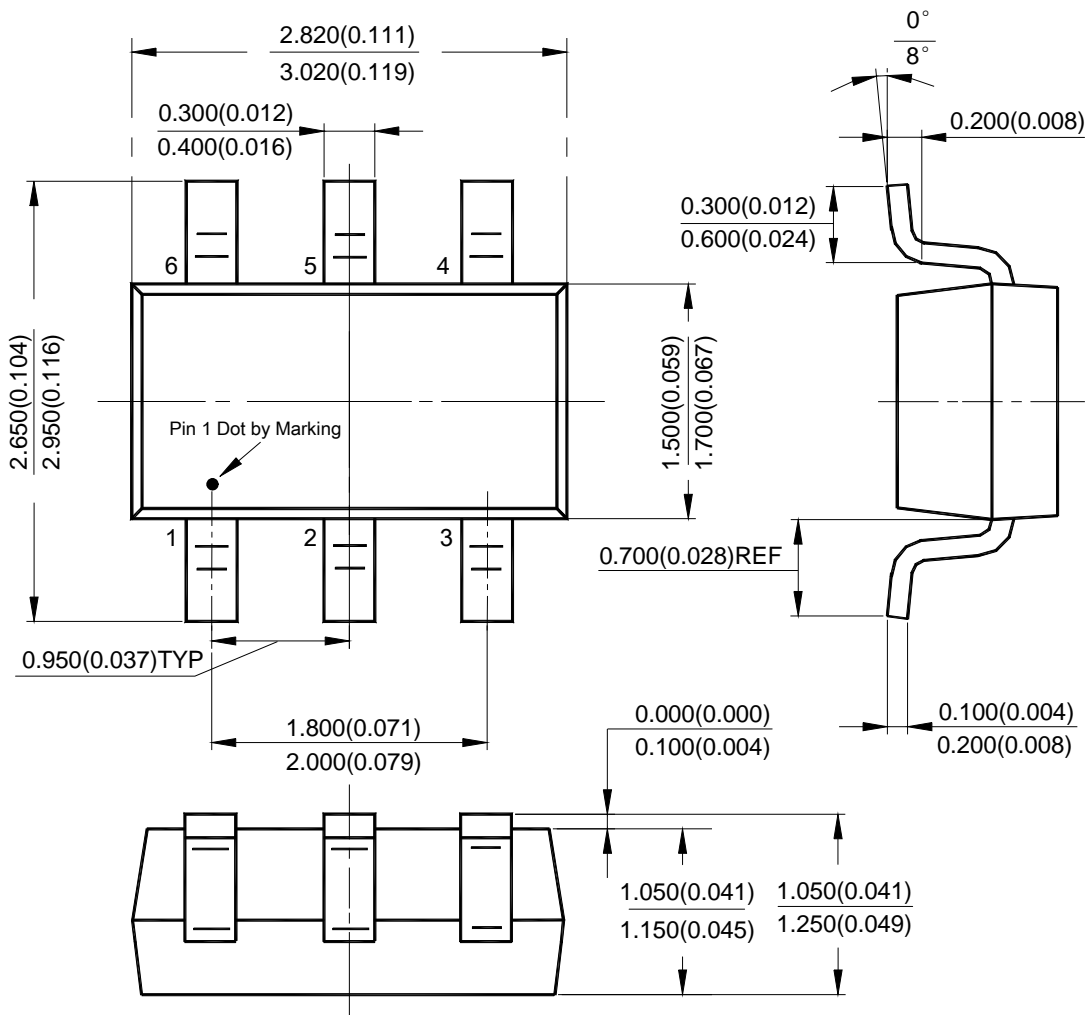



WHITE LED STEP-UP CONVERTER

AP3029

Mechanical Dimensions

TSOT-23-6

Unit: mm(inch)

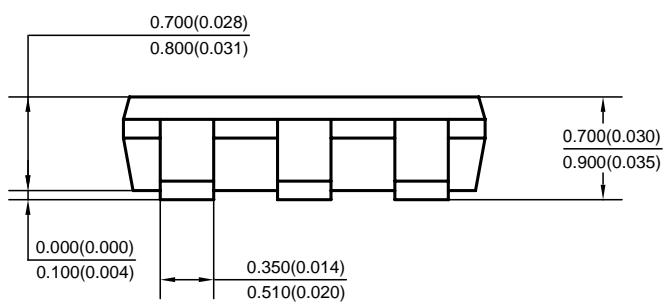
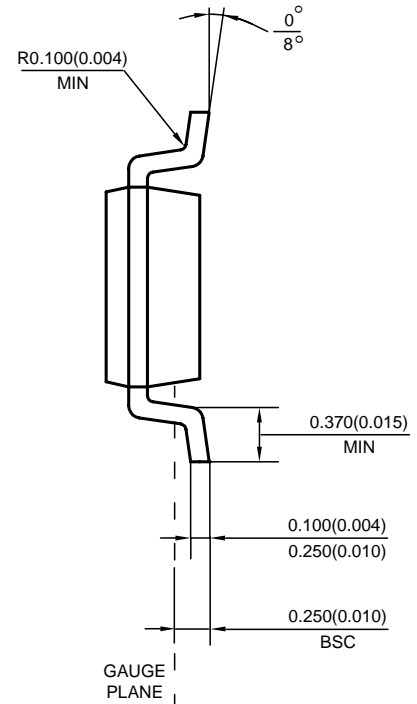
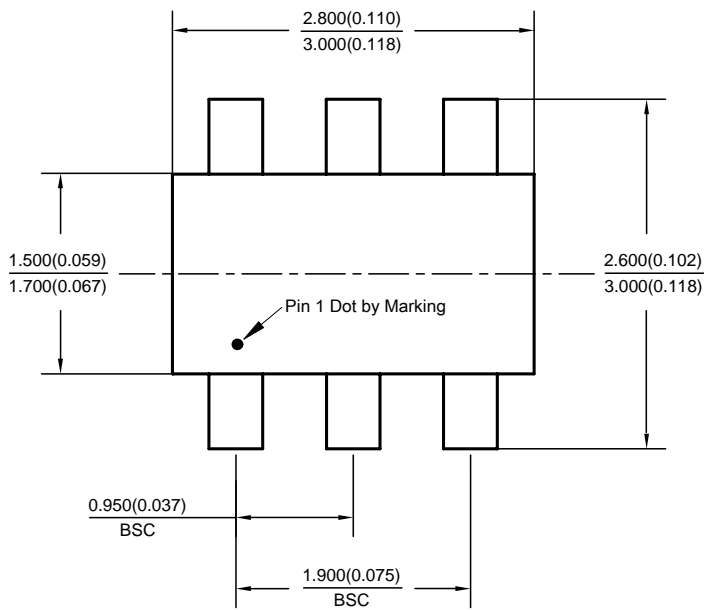



BCD Semiconductor Manufacturing Limited

<http://www.bcdsemi.com>

IMPORTANT NOTICE

BCD Semiconductor Manufacturing Limited reserves the right to make changes without further notice to any products or specifications herein. BCD Semiconductor Manufacturing Limited does not assume any responsibility for use of any its products for any particular purpose, nor does BCD Semiconductor Manufacturing Limited assume any liability arising out of the application or use of any its products or circuits. BCD Semiconductor Manufacturing Limited does not convey any license under its patent rights or other rights nor the rights of others.

MAIN SITE

- Headquarters

BCD Semiconductor Manufacturing Limited

No. 1600, Zi Xing Road, Shanghai Zizhu Science-based Industrial Park, 200241, China
Tel: +86-21-24162266, Fax: +86-21-24162277

- Wafer Fab

Shanghai SIM-BCD Semiconductor Manufacturing Co., Ltd.

800 Yi Shan Road, Shanghai 200233, China
Tel: +86-21-6485 1491, Fax: +86-21-5450 0008

REGIONAL SALES OFFICE

Shenzhen Office

Shanghai SIM-BCD Semiconductor Manufacturing Co., Ltd., Shenzhen Office
Room E, 5F, Noble Center, No.1006, 3rd Fuzhong Road, Futian District, Shenzhen,
518026, China
Tel: +86-755-8826 7951
Fax: +86-755-8826 7865

Taiwan Office

BCD Semiconductor (Taiwan) Company Limited
4F, 298-1, Rui Guang Road, Nei-Hu District, Taipei,
Taiwan
Tel: +886-2-2656 2808
Fax: +886-2-2656 2806

USA Office

BCD Semiconductor Corp.
30920 Huntwood Ave. Hayward,
CA 94544, USA
Tel : +1-510-324-2988
Fax: +1-510-324-2788