



# Fully Accurate, 12-/14-/16-Bit $V_{OUT}$ *nanoDAC*, Quad, SPI Interface, 4.5 V to 5.5 V in TSSOP

## AD5024/AD5044/AD5064

### FEATURES

- Low power quad 12-/14-/16-bit DAC,  $\pm 1$  LSB INL
- Individual and common voltage reference pin options
- Rail-to-rail operation
- 4.5 V to 5.5 V power supply
- Power-on reset to zero-scale or midscale
- 3 power-down functions
- Per-channel power-down
- Low glitch on power-up
- Hardware LDAC with LDAC override function
- CLR function to programmable code
- 16-lead TSSOP
- Internal reference buffer and internal output amplifier

### APPLICATIONS

- Process control
- Data acquisition systems
- Portable battery-powered instruments
- Digital gain and offset adjustment
- Programmable voltage and current sources
- Programmable attenuators

Table 1. Related Devices

Part No.	Description
AD5666	Quad, 16-bit buffered DAC, 16 LSB INL, TSSOP
AD5063/AD5062	16-bit <i>nanoDAC</i> , 1 LSB INL
AD5061	16-/14-bit <i>nanoDAC</i> , 4 LSB INL, SOT-23
AD5060/AD5040	16-/14-bit <i>nanoDAC</i> , 1 LSB INL, SOT-23

### GENERAL DESCRIPTION

The AD5024/AD5044/AD5064 are low power, quad 12-/14-/16-bit buffered voltage output *nanoDAC*® DACs that offer relative accuracy specifications of 1 LSB INL with individual reference pins and can operate from a single 4.5 V to 5.5 V supply. The AD5024/AD5044/AD5064 parts also offer a differential accuracy specification of  $\pm 1$  LSB. The parts use a versatile 3-wire, low power Schmitt trigger serial interface that operates at clock rates up to 50 MHz and is compatible with standard SPI, QSPI™, MICROWIRE™, and DSP interface standards. A reference buffer is also provided on-chip. The AD5024/AD5044/AD5064 incorporate a power-on reset circuit that ensures the DAC output powers up to zero scale or midscale and remains there until a valid write takes place to the device. The AD5024/AD5044/AD5064 contain a power-down feature that reduces the current consumption of the device to typically 400 nA at 5 V and provides software selectable output loads while in power-down mode. Total unadjusted error for the parts is  $< 2$  mV.

### PRODUCT HIGHLIGHTS

1. Quad channel available in 16-lead TSSOP package.
2. 16-bit accurate, 1 LSB INL.
3. Low glitch on power-up.
4. High speed serial interface with clock speeds up to 50 MHz.
5. Reset to known output voltage (zero scale or midscale).

### FUNCTIONAL BLOCK DIAGRAM

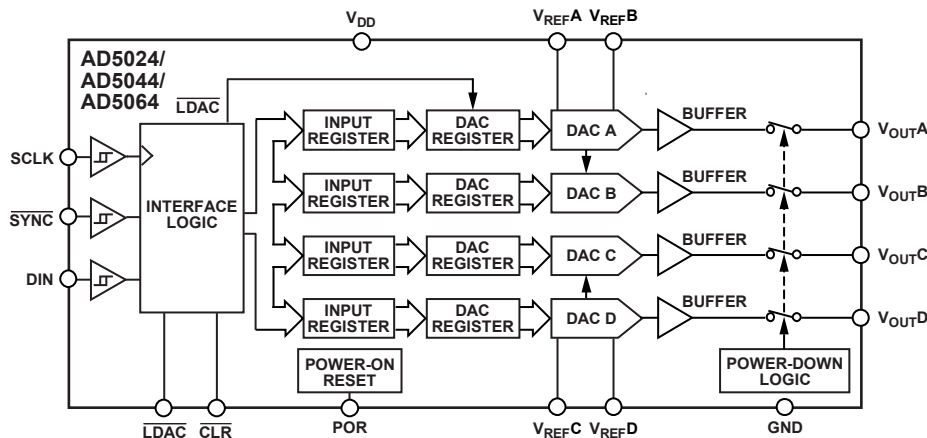

Figure 1.

### Rev. 0

Information furnished by Analog Devices is believed to be accurate and reliable. However, no responsibility is assumed by Analog Devices for its use, nor for any infringements of patents or other rights of third parties that may result from its use. Specifications subject to change without notice. No license is granted by implication or otherwise under any patent or patent rights of Analog Devices. Trademarks and registered trademarks are the property of their respective owners.

One Technology Way, P.O. Box 9106, Norwood, MA 02062-9106, U.S.A.  
 Tel: 781.329.4700  
 Fax: 781.461.3113  
[www.analog.com](http://www.analog.com)  
 ©2008 Analog Devices, Inc. All rights reserved.

## TABLE OF CONTENTS

Features .....	1	Output Amplifier.....	18
Applications.....	1	Serial Interface.....	18
General Description.....	1	Standalone Mode.....	18
Product Highlights .....	1	Input Shift Register .....	19
Functional Block Diagram .....	1	$\overline{\text{SYNC}}$ Interrupt .....	19
Revision History .....	2	Power-On Reset.....	20
Specifications.....	3	Power-Down Modes .....	20
AC Characteristics.....	5	Clear Code Register .....	21
Timing Characteristics .....	6	$\overline{\text{LDAC}}$ Function .....	21
Absolute Maximum Ratings.....	7	Power Supply Bypassing and Grounding.....	21
ESD Caution.....	7	Microprocessor Interfacing.....	23
Pin Configuration and Function Descriptions.....	8	Applications.....	24
Typical Performance Characteristics .....	9	Using a Reference as a Power Supply.....	24
Terminology .....	16	Bipolar Operation.....	24
Theory of Operation .....	18	Using the AD5024/AD5044/AD5064 with a Galvanically Isolated Interface .....	24
DAC Section.....	18	Outline Dimensions .....	25
DAC Architecture.....	18	Ordering Guide .....	25
Reference Buffer .....	18		

## REVISION HISTORY

8/08—Revision 0: Initial Version

## SPECIFICATIONS

$V_{DD} = 4.5\text{ V to }5.5\text{ V}$ ,  $R_L = 5\text{ k}\Omega$  to GND,  $C_L = 200\text{ pF}$  to GND,  $2.5\text{ V} \leq V_{REFIN} \leq V_{DD}$ , unless otherwise specified. All specifications  $T_{MIN}$  to  $T_{MAX}$ , unless otherwise noted.

Table 2.

Parameter	B Grade <sup>1</sup>			A Grade <sup>1,2</sup>			Unit	Conditions/Comments
	Min	Typ	Max	Min	Typ	Max		
STATIC PERFORMANCE <sup>3</sup>								
Resolution	16			16			Bits	AD5064 AD5044 AD5024
Relative Accuracy		$\pm 0.5$	$\pm 1$		$\pm 0.5$	$\pm 4$	LSB	AD5064; $T_A = -40^\circ\text{C to }+105^\circ\text{C}$
		$+0.5$	$\pm 2$		$\pm 0.5$	$\pm 4$		AD5064; $T_A = -40^\circ\text{C to }+125^\circ\text{C}$
		$\pm 0.25$	$\pm 0.5$				LSB	AD5044; $T_A = -40^\circ\text{C to }+105^\circ\text{C}$
		$\pm 0.25$	$\pm 1$					AD5044; $T_A = -40^\circ\text{C to }+125^\circ\text{C}$
		$\pm 0.12$	$\pm 0.25$				LSB	AD5024; $T_A = -40^\circ\text{C to }+105^\circ\text{C}$
Differential Nonlinearity		$\pm 0.12$	$\pm 0.5$				LSB	AD5024; $T_A = -40^\circ\text{C to }+125^\circ\text{C}$
Offset Error		$\pm 0.2$	$\pm 1$		$\pm 0.2$	$\pm 1$	LSB	
Offset Error Drift <sup>4</sup>		$\pm 2$			$\pm 2$		$\mu\text{V}/^\circ\text{C}$	
Full-Scale Error		$\pm 0.01$	$\pm 0.07$		$\pm 0.01$	$\pm 0.07$	% FSR	All 1s loaded to DAC register. $V_{REF} < V_{DD}$
Gain Error		$\pm 0.005$	$\pm 0.05$		$\pm 0.005$	$\pm 0.05$	% FSR	
Gain Temperature Coefficient <sup>4</sup>		$\pm 1$			$\pm 1$		ppm	Of FSR/ $^\circ\text{C}$
DC Crosstalk		40			40		$\mu\text{V}$	Due to single channel full-scale output change, $R_L = 5\text{ k}\Omega$ to GND or $V_{DD}$
		40			40		$\mu\text{V}/\text{mA}$	Due to load current change
		0.5			40		$\mu\text{V}$	Due to powering down (per channel)
OUTPUT CHARACTERISTICS <sup>4</sup>								
Output Voltage Range	0		$V_{DD}$	0		$V_{DD}$	V	
Capacitive Load Stability		1			1		nF	$R_L = 5\text{ k}\Omega$ , $R_L = 100\text{ k}\Omega$ , and $R_L = \infty$
DC Output Impedance							$\Omega$	
Normal Mode		0.5			0.5		$\Omega$	
Power-Down Mode								
Output Connected to 100 k $\Omega$ Network		100			100		k $\Omega$	Output impedance tolerance $\pm 400\ \Omega$
Output Connected to 1 k $\Omega$ Network		1			1		k $\Omega$	Output impedance tolerance $\pm 20\ \Omega$
Short-Circuit Current		60			60		mA	DAC = full scale, output shorted to GND
		45			45		mA	DAC = zero-scale, output shorted to $V_{DD}$
Power-Up Time		4.5			4.5		$\mu\text{s}$	Time to exit power-down mode to normal mode of AD5024/AD5044/AD5064, 32 <sup>nd</sup> clock edge to 90% of DAC midscale value, output unloaded
DC PSRR		-92			-92		dB	$V_{DD} \pm 10\%$ , DAC = full scale. $V_{REF} < V_{DD}$
REFERENCE INPUTS								
Reference Input Range	2.5		$V_{DD}$	2.5		$V_{DD}$	V	
Reference Current		35	50		35	50	$\mu\text{A}$	Per DAC channel
Reference Input Impedance		120			120		k $\Omega$	Individual reference option
LOGIC INPUTS								
Input Current <sup>5</sup>			$\pm 1$			$\pm 1$	$\mu\text{A}$	
Input Low Voltage, $V_{INL}$			0.8			0.8	V	
Input High Voltage, $V_{INH}$	2.2			2.2			V	
Pin Capacitance <sup>4</sup>		4			4		pF	

# AD5024/AD5044/AD5064

Parameter	B Grade <sup>1</sup>			A Grade <sup>1,2</sup>			Unit	Conditions/Comments
	Min	Typ	Max	Min	Typ	Max		
POWER REQUIREMENTS								
V <sub>DD</sub>	4.5		5.5	4.5		5.5	V	DAC active, excludes load current
I <sub>DD</sub> <sup>6</sup>								V <sub>IH</sub> = V <sub>DD</sub> and V <sub>IL</sub> = GND
Normal Mode		3	6		3	6	mA	T <sub>A</sub> = -40°C to +105°C
All Power-Down Modes <sup>7</sup>		0.4	2		0.4	2	μA	T <sub>A</sub> = -40°C to +125°C
			30			30	μA	

<sup>1</sup> Temperature range is -40°C to +125°C, typical at 25°C.

<sup>2</sup> A grade offered in AD5064 only.

<sup>3</sup> Linearity calculated using a reduced code range—AD5064: Code 512 to Code 65,024; AD5044: Code 128 to Code 16,256; AD5024: Code 32 to Code 4064. Output unloaded.

<sup>4</sup> Guaranteed by design and characterization; not production tested.

<sup>5</sup> Current flowing into individual digital pins.

<sup>6</sup> Interface inactive. All DACs active. DAC outputs unloaded.

<sup>7</sup> All four DACs powered down.

**AC CHARACTERISTICS**

$V_{DD} = 4.5\text{ V to }5.5\text{ V}$ ,  $R_L = 5\text{ k}\Omega$  to GND,  $C_L = 200\text{ pF}$  to GND,  $2.5\text{ V} \leq V_{REFIN} \leq V_{DD}$ . All specifications  $T_{MIN}$  to  $T_{MAX}$ , unless otherwise noted.

**Table 3.**

Parameter <sup>1,2</sup>	Min	Typ	Max	Unit	Conditions/Comments <sup>3</sup>
Output Voltage Settling Time	5.8	8		$\mu\text{s}$	$\frac{1}{4}$ to $\frac{3}{4}$ scale and $\frac{3}{4}$ to $\frac{1}{4}$ scale settling to $\pm 1$ LSB, $R_L = 5\text{ k}\Omega$ , single channel update including DAC calibration sequence
	10.7	13		$\mu\text{s}$	$\frac{1}{4}$ to $\frac{3}{4}$ scale and $\frac{3}{4}$ to $\frac{1}{4}$ scale settling to $\pm 1$ LSB, $R_L = 5\text{ k}\Omega$ , all channel update including DAC calibration sequence
Slew Rate		1.5		$\text{V}/\mu\text{s}$	
Digital-to-Analog Glitch Impulse		3		$\text{nV}\cdot\text{s}$	1 LSB change around major carry
Reference Feedthrough		-90		$\text{dB}$	$V_{REF} = 3\text{ V} \pm 0.86\text{ V p-p}$ , frequency = 100 Hz to 100 kHz
Digital Feedthrough		0.1		$\text{nV}\cdot\text{s}$	
Digital Crosstalk		1.9		$\text{nV}\cdot\text{s}$	
Analog Crosstalk		2		$\text{nV}\cdot\text{s}$	
DAC-to-DAC Crosstalk		3.5		$\text{nV}\cdot\text{s}$	
AC Crosstalk		6		$\text{nV}\cdot\text{s}$	
Multiplying Bandwidth		340		$\text{kHz}$	$V_{REF} = 3\text{ V} \pm 0.86\text{ V p-p}$
Total Harmonic Distortion		-80		$\text{dB}$	$V_{REF} = 3\text{ V} \pm 0.2\text{ V p-p}$ , frequency = 10 kHz
Output Noise Spectral Density		64		$\text{nV}/\sqrt{\text{Hz}}$	DAC code = 0x8400, 1 kHz
		60		$\text{nV}/\sqrt{\text{Hz}}$	DAC code = 0x8400, 10 kHz
Output Noise		6		$\mu\text{V p-p}$	0.1 Hz to 10 Hz

<sup>1</sup> Guaranteed by design and characterization; not production tested.

<sup>2</sup> See the Terminology section.

<sup>3</sup> Temperature range is  $-40^\circ\text{C}$  to  $+125^\circ\text{C}$ , typical at  $25^\circ\text{C}$ .

# AD5024/AD5044/AD5064

## TIMING CHARACTERISTICS

All input signals are specified with  $t_R = t_F = 1 \text{ ns/V}$  (10% to 90% of  $V_{DD}$ ) and timed from a voltage level of  $(V_{IL} + V_{IH})/2$ . See Figure 2.  $V_{DD} = 4.5 \text{ V}$  to  $5.5 \text{ V}$ . All specifications  $T_{MIN}$  to  $T_{MAX}$ , unless otherwise noted.

Table 4.

Parameter <sup>1</sup>	Limit at $T_{MIN}$ , $T_{MAX}$ ; $V_{DD} = 4.5 \text{ V}$ to $5.5 \text{ V}$	Unit	Conditions/Comments
$t_1$	20	ns min	SCLK cycle time
$t_2$	10	ns min	SCLK high time
$t_3$	10	ns min	SCLK low time
$t_4$	16.5	ns min	$\overline{\text{SYNC}}$ to SCLK falling edge setup time
$t_5$	5	ns min	Data setup time
$t_6$	5	ns min	Data hold time
$t_7$	0	ns min	SCLK falling edge to $\overline{\text{SYNC}}$ rising edge
$t_8$	1.9	$\mu\text{s}$ min	Minimum $\overline{\text{SYNC}}$ high time (single channel update)
	10.5	$\mu\text{s}$ min	Minimum $\overline{\text{SYNC}}$ high time (all channel update)
$t_9$	17	ns min	$\overline{\text{SYNC}}$ rising edge to SCLK fall ignore
$t_{10}$	20	ns min	$\overline{\text{LDAC}}$ pulse width low
$t_{11}$	20	ns min	SCLK falling edge to $\overline{\text{LDAC}}$ rising edge
$t_{12}$	10	ns min	$\overline{\text{CLR}}$ pulse width low
$t_{13}$	10	ns min	SCLK falling edge to $\overline{\text{LDAC}}$ falling edge
$t_{14}$	10.6	$\mu\text{s}$ min	$\overline{\text{CLR}}$ pulse activation time

<sup>1</sup> Guaranteed by design and characterization; not production tested.

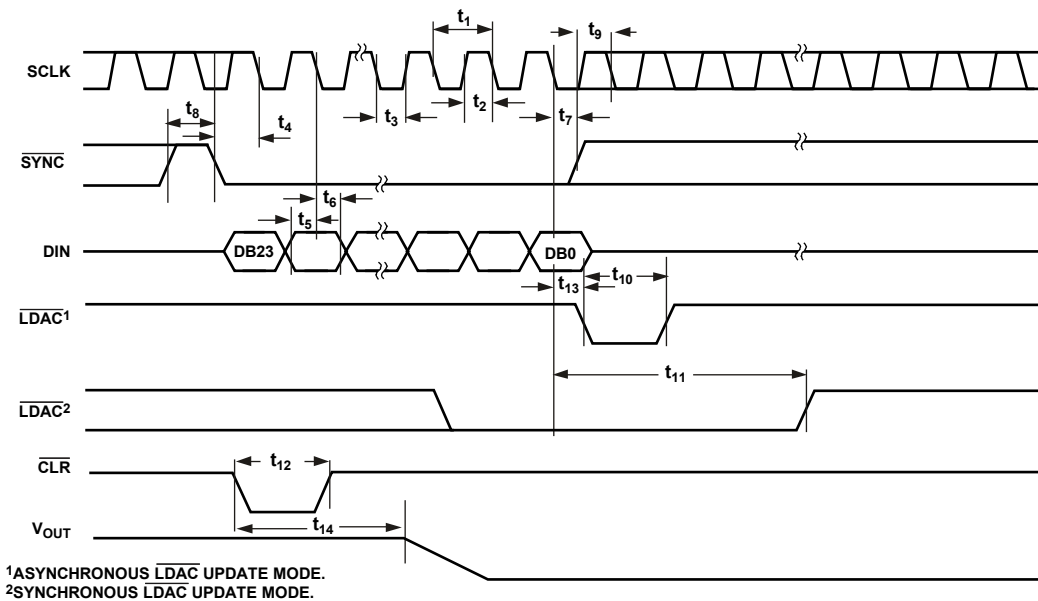

Figure 2. Serial Write Operation

## ABSOLUTE MAXIMUM RATINGS

$T_A = 25^\circ\text{C}$ , unless otherwise noted.

Table 5.

Parameter	Rating
$V_{DD}$ to GND	-0.3 V to +7 V
Digital Input Voltage to GND	-0.3 V to $V_{DD} + 0.3$ V
$V_{OUT}$ to GND	-0.3 V to $V_{DD} + 0.3$ V
$V_{REF}$ to GND	-0.3 V to $V_{DD} + 0.3$ V
Operating Temperature Range	
Industrial	-40°C to +125°C
Storage Temperature Range	-65°C to +150°C
Junction Temperature ( $T_{J\text{ MAX}}$ )	150°C
TSSOP Package	
Power Dissipation	$(T_{J\text{ MAX}} - T_A)/\theta_{JA}$
$\theta_{JA}$ Thermal Impedance	113°C/W
Reflow Soldering Peak Temperature	
Pb Free	260°C

Stresses above those listed under Absolute Maximum Ratings may cause permanent damage to the device. This is a stress rating only; functional operation of the device at these or any other conditions above those indicated in the operational section of this specification is not implied. Exposure to absolute maximum rating conditions for extended periods may affect device reliability.

### ESD CAUTION



**ESD (electrostatic discharge) sensitive device.** Charged devices and circuit boards can discharge without detection. Although this product features patented or proprietary protection circuitry, damage may occur on devices subjected to high energy ESD. Therefore, proper ESD precautions should be taken to avoid performance degradation or loss of functionality.

# AD5024/AD5044/AD5064

## PIN CONFIGURATION AND FUNCTION DESCRIPTIONS

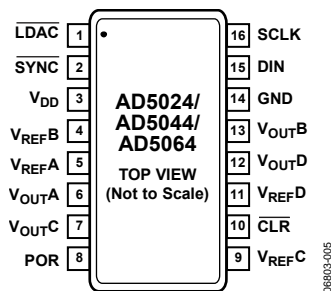

Figure 3. 16-Lead TSSOP (RU-16) Pin Configuration

Table 6. Pin Function Descriptions

Pin No.	Mnemonic	Description
1	$\overline{\text{LDAC}}$	Pulsing this pin low allows any or all DAC registers to be updated if the input registers have new data. This allows all DAC outputs to simultaneously update. Alternatively, this pin can be tied permanently low.
2	$\overline{\text{SYNC}}$	Active Low Control Input. This is the frame synchronization signal for the input data. When $\overline{\text{SYNC}}$ goes low, it powers on the SCLK and DIN buffers and enables the input shift register. Data is transferred in on the falling edges of the next 32 clocks. If $\overline{\text{SYNC}}$ is taken high before the 32 <sup>nd</sup> falling edge, the rising edge of $\overline{\text{SYNC}}$ acts as an interrupt and the write sequence is ignored by the device.
3	$V_{\text{DD}}$	Power Supply Input. These parts can be operated from 4.5 V to 5.5 V, and the supply should be decoupled with a 10 $\mu\text{F}$ capacitor in parallel with a 0.1 $\mu\text{F}$ capacitor to GND.
4	$V_{\text{REFB}}$	DAC B Reference Input. This is the reference voltage input pin for DAC B.
5	$V_{\text{REFA}}$	DAC A Reference Input. This is the reference voltage input pin for DAC A.
6	$V_{\text{OUTA}}$	Analog Output Voltage from DAC A. The output amplifier has rail-to-rail operation.
7	$V_{\text{OUTC}}$	Analog Output Voltage from DAC C. The output amplifier has rail-to-rail operation.
8	POR	Power-On Reset. Tying this pin to GND powers up the part to 0 V. Tying this pin to $V_{\text{DD}}$ powers up the part to midscale.
9	$V_{\text{REFC}}$	DAC C Reference Input. This is the reference voltage input pin for DAC C.
10	$\overline{\text{CLR}}$	Asynchronous Clear Input. The $\overline{\text{CLR}}$ input is falling edge sensitive. When $\overline{\text{CLR}}$ is low, all $\overline{\text{LDAC}}$ pulses are ignored. When $\overline{\text{CLR}}$ is activated, the input register and the DAC register are updated with the data contained in the $\overline{\text{CLR}}$ code register—zero, midscale, or full scale. Default setting clears the output to 0 V.
11	$V_{\text{REFD}}$	DAC D Reference Input. This is the reference voltage input pin for DAC D.
12	$V_{\text{OUTD}}$	Analog Output Voltage from DAC D. The output amplifier has rail-to-rail operation.
13	$V_{\text{OUTB}}$	Analog Output Voltage from DAC B. The output amplifier has rail-to-rail operation.
14	GND	Ground Reference Point for All Circuitry on the Part.
15	DIN	Serial Data Input. This device has a 32-bit shift register. Data is clocked into the register on the falling edge of the serial clock input.
16	SCLK	Serial Clock Input. Data is clocked into the input shift register on the falling edge of the serial clock input. Data can be transferred at rates of up to 50 MHz.



# TYPICAL PERFORMANCE CHARACTERISTICS

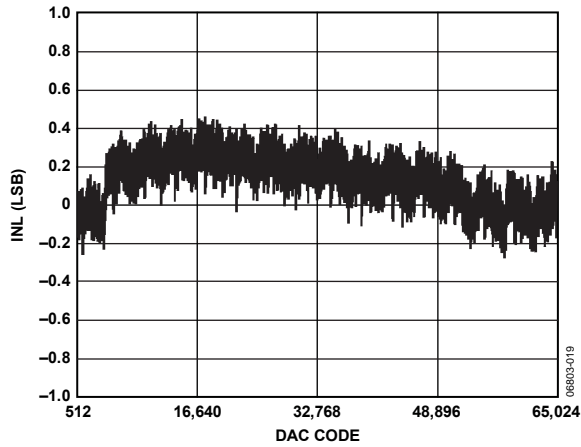

Figure 4. AD5064 INL

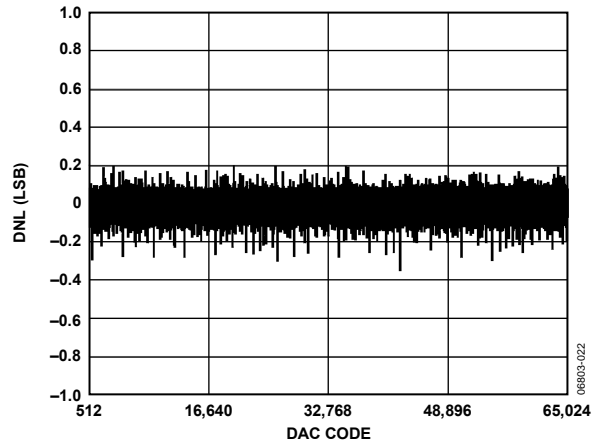

Figure 7. AD5064 DNL

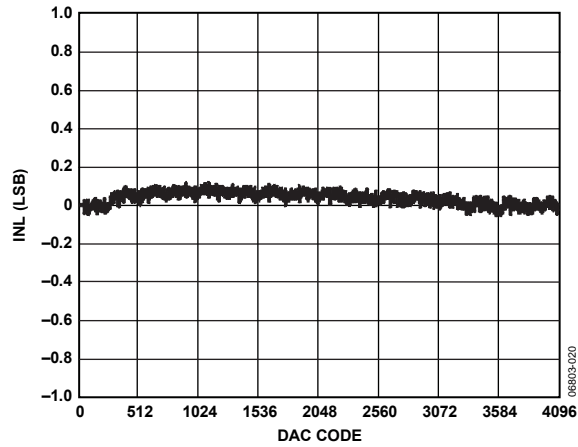

Figure 5. AD5044 INL

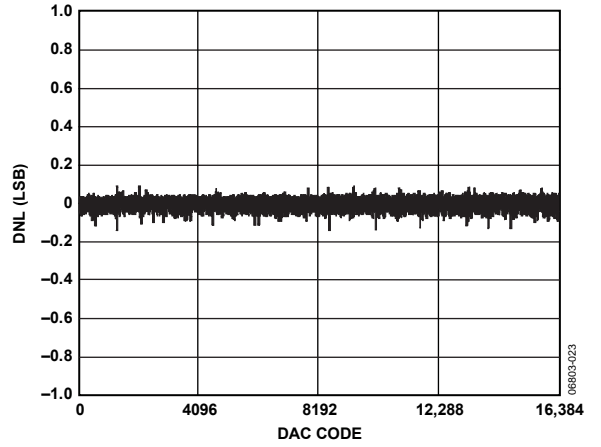

Figure 8. AD5044 DNL

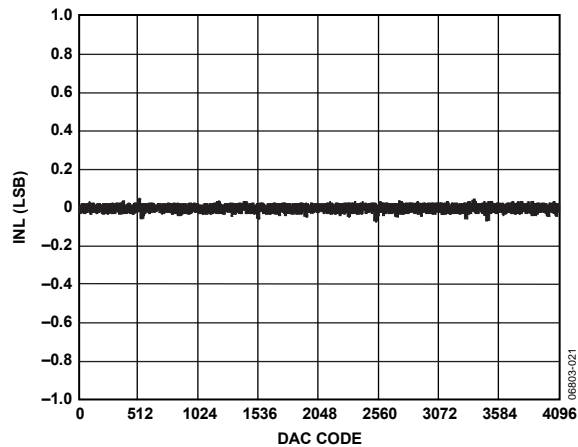

Figure 6. AD5024 INL

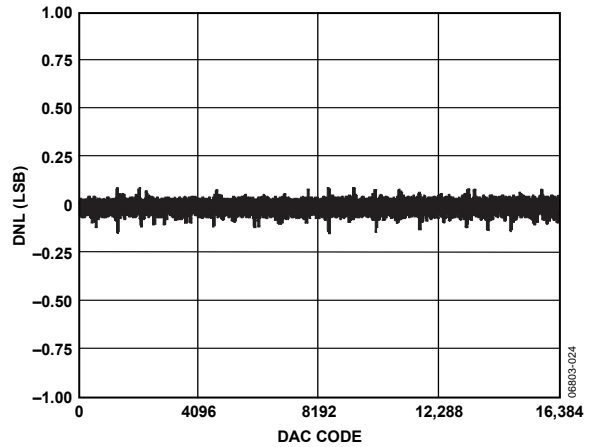

Figure 9. AD5024 DNL

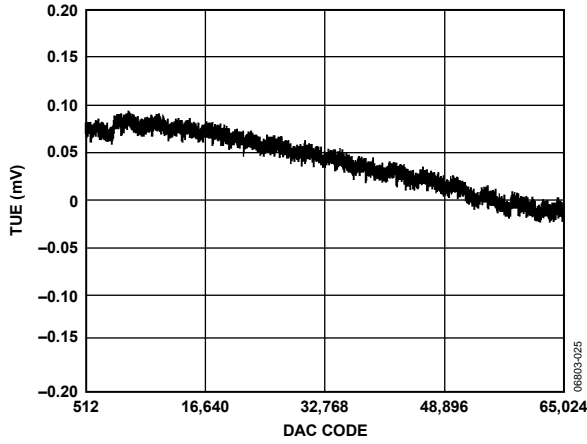

Figure 10. Total Unadjusted Error (TUE)

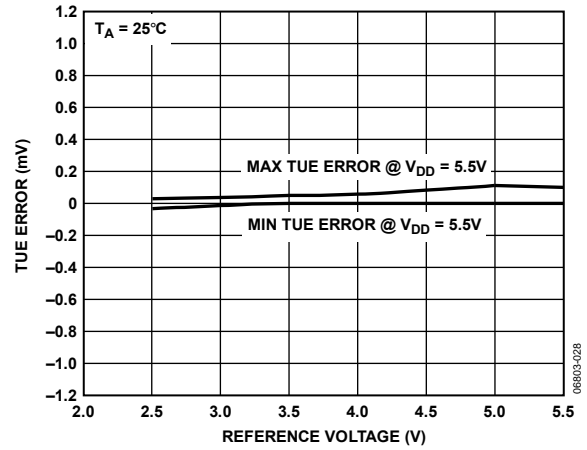

Figure 13. TUE vs. Reference Input Voltage

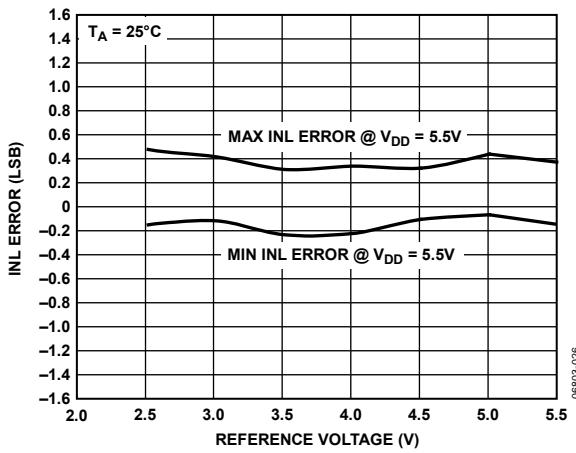

Figure 11. INL vs. Reference Input Voltage

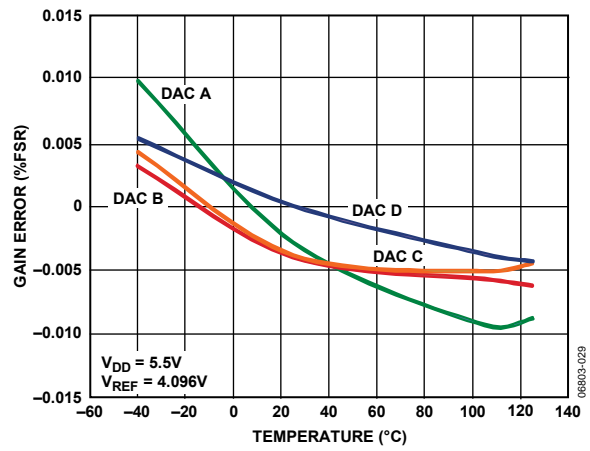

Figure 14. Gain Error vs. Temperature

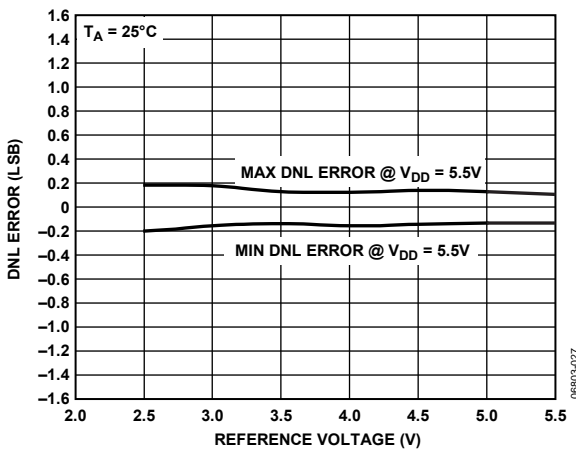

Figure 12. DNL vs. Reference Input Voltage

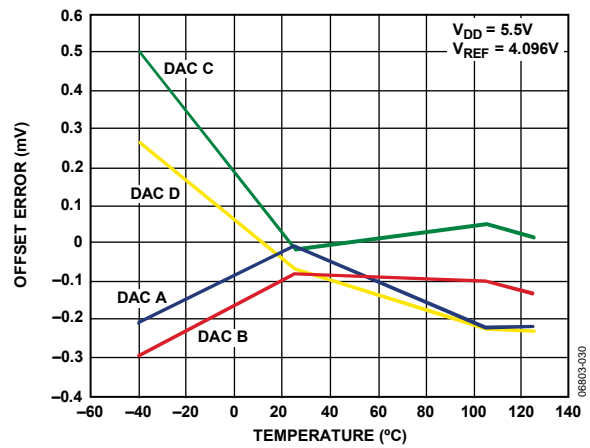

Figure 15. Offset Error vs. Temperature

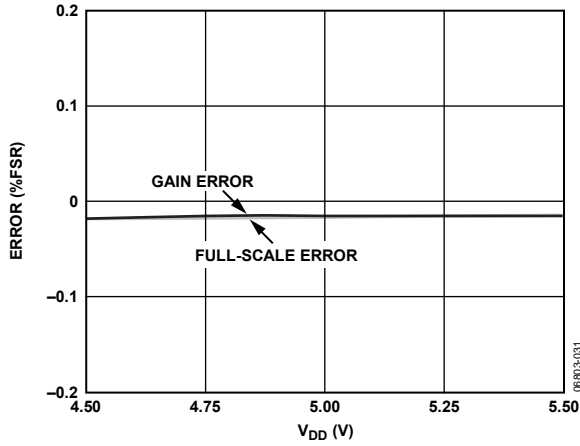

Figure 16. Gain Error and Full-Scale Error vs. Supply Voltage

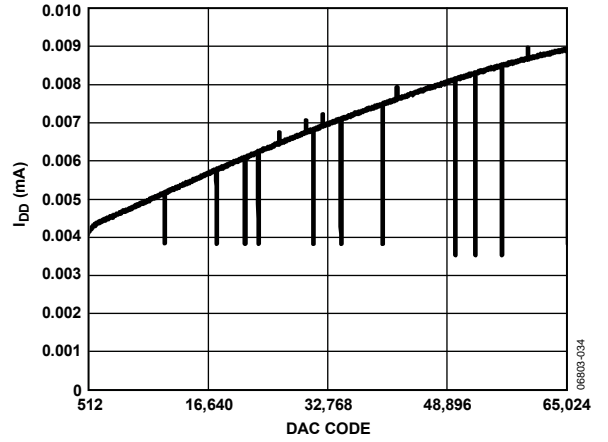

Figure 19. Supply Current vs. Code

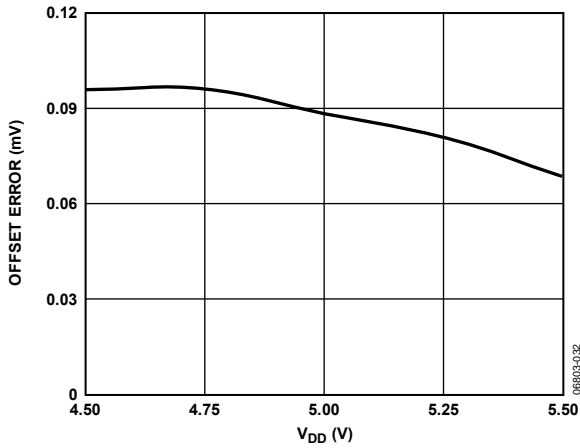

Figure 17. Offset Error Voltage vs. Supply Voltage

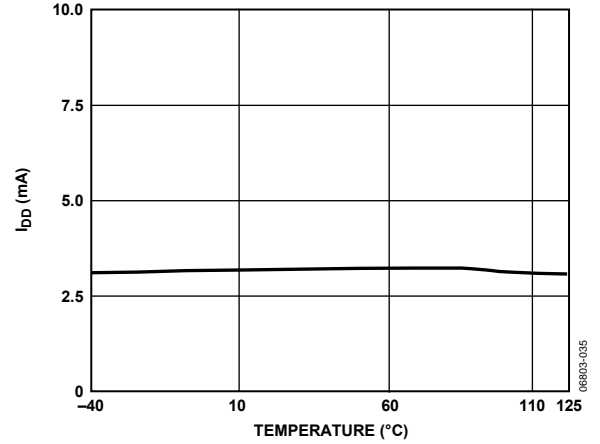

Figure 20. Supply Current vs. Temperature

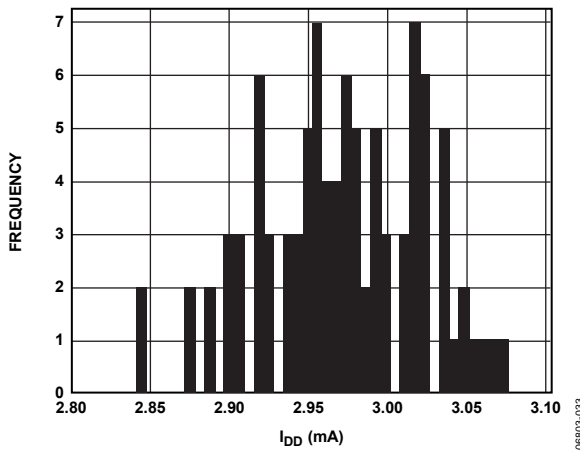

Figure 18.  $I_{DD}$  Histogram,  $V_{DD} = 5.0 V$

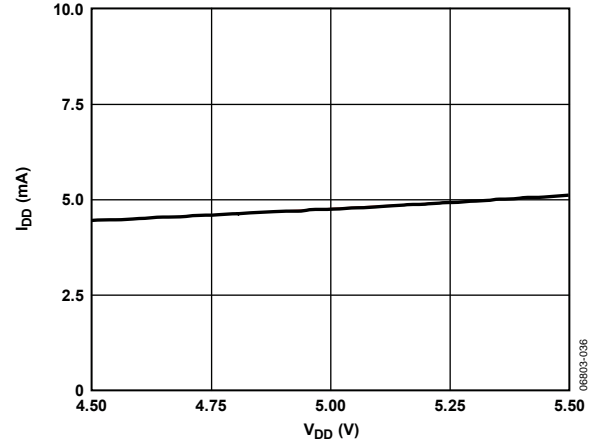

Figure 21. Supply Current vs. Supply Voltage

# AD5024/AD5044/AD5064

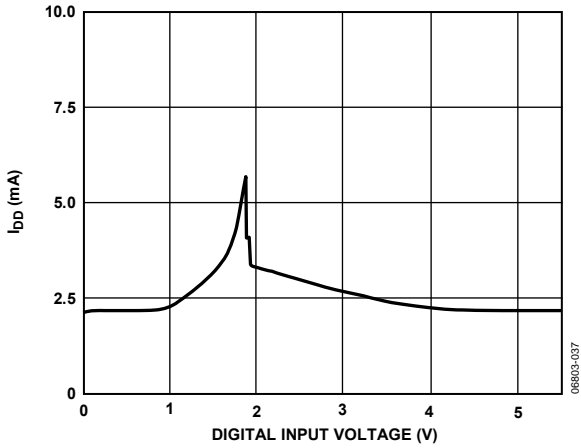

Figure 22. Supply Current vs. Digital Input Voltage

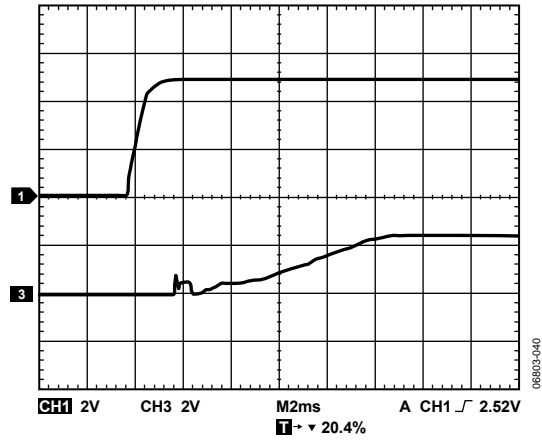

Figure 25. Power-On Reset to Midscale

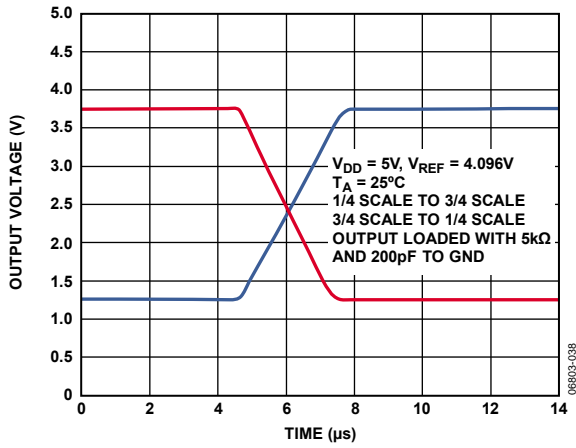

Figure 23. Settling Time

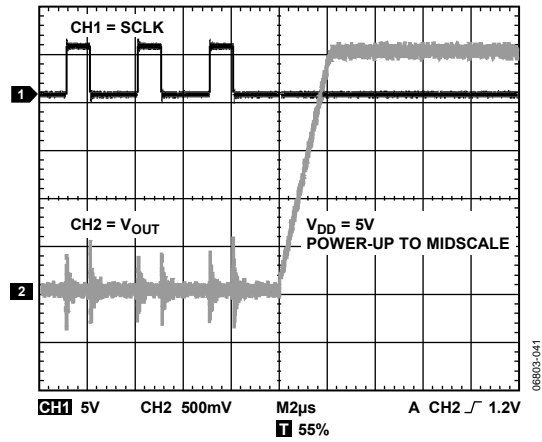

Figure 26. Exiting Power-Down to Midscale

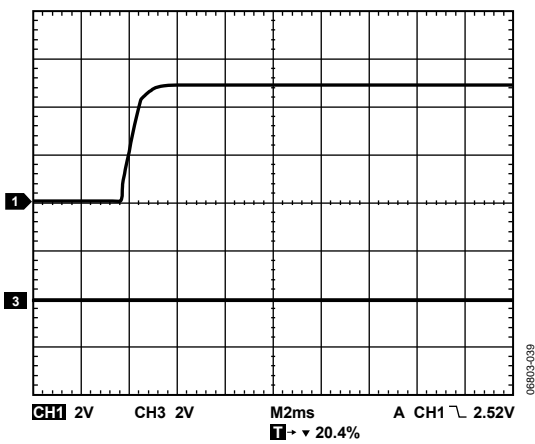

Figure 24. Power-On Reset to 0V

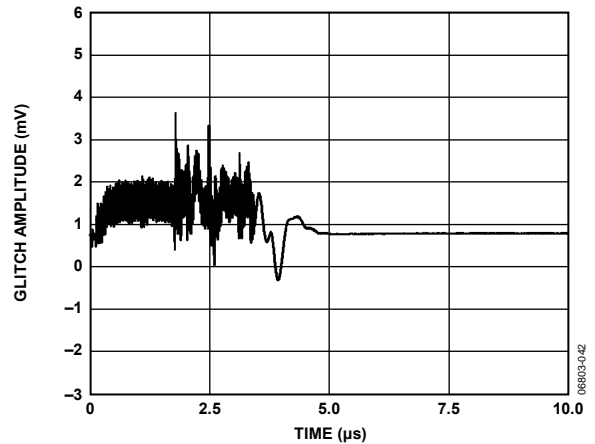

Figure 27. Digital-to-Analog Glitch Impulse

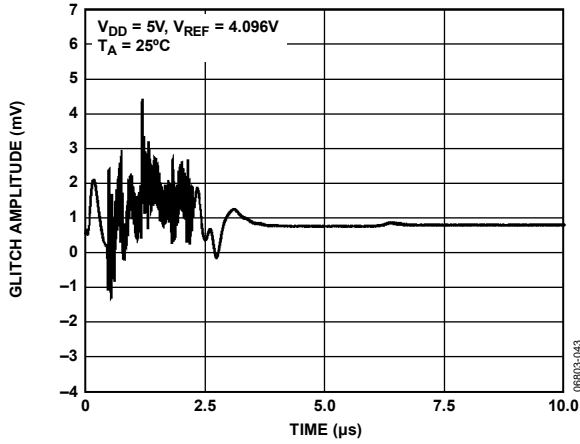

Figure 28. Analog Crosstalk

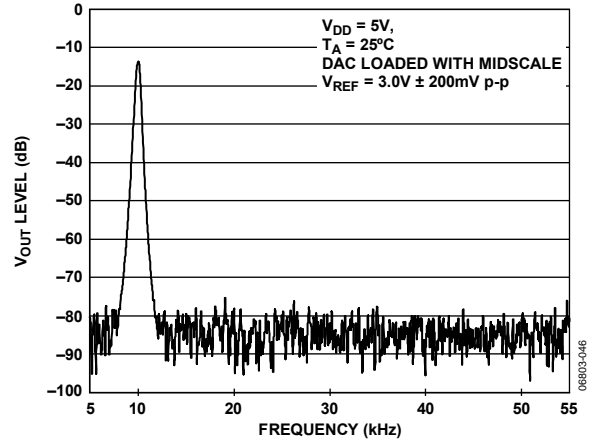

Figure 31. Total Harmonic Distortion

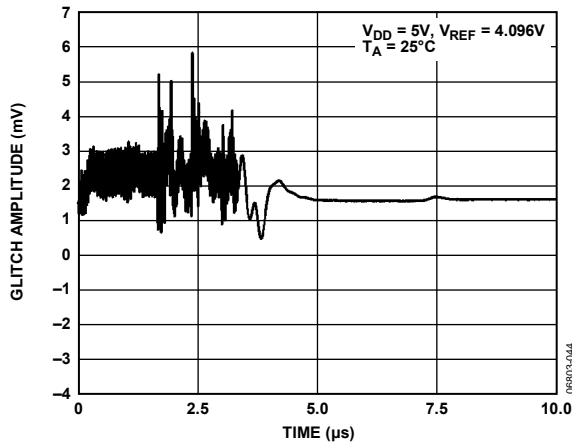

Figure 29. DAC-to-DAC Crosstalk

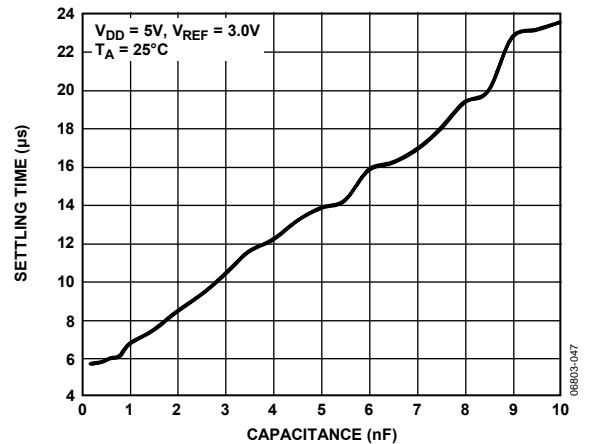

Figure 32. Settling Time vs. Capacitive Load

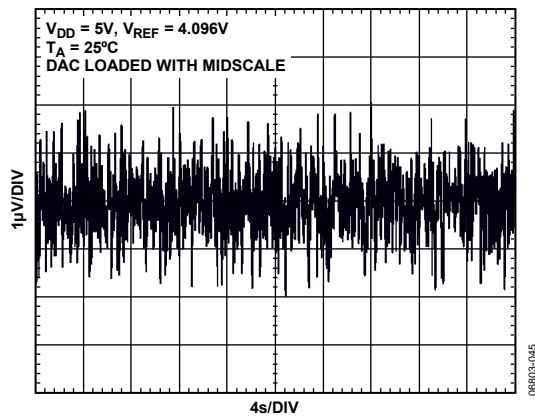

Figure 30. 0.1 Hz to 10 Hz Output Noise Plot

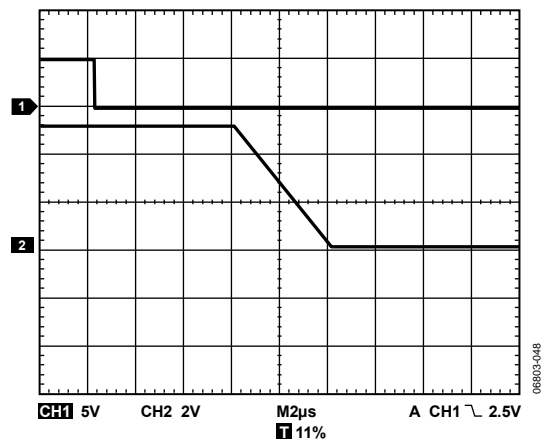

Figure 33. Hardware  $\overline{CLR}$

# AD5024/AD5044/AD5064

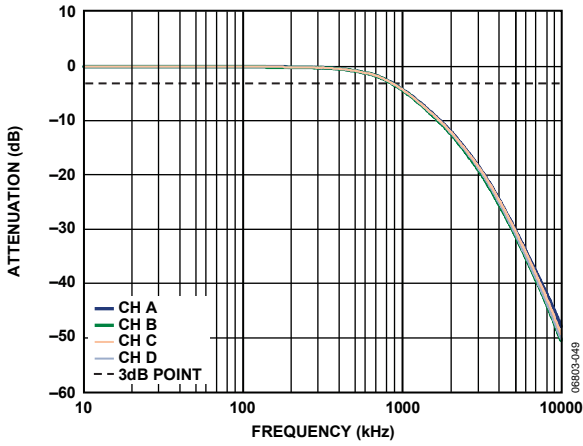

Figure 34. Multiplying Bandwidth

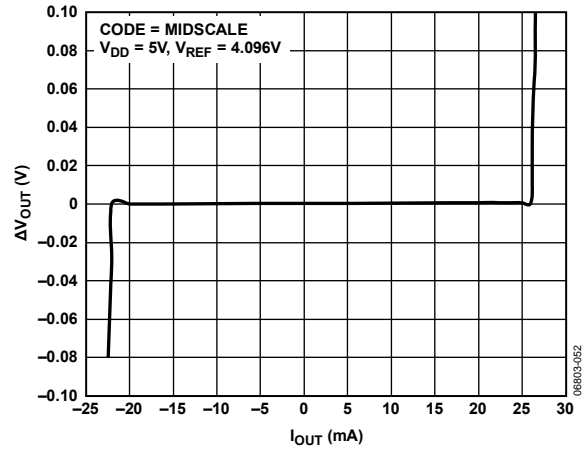

Figure 37. Typical Current Limiting Plot

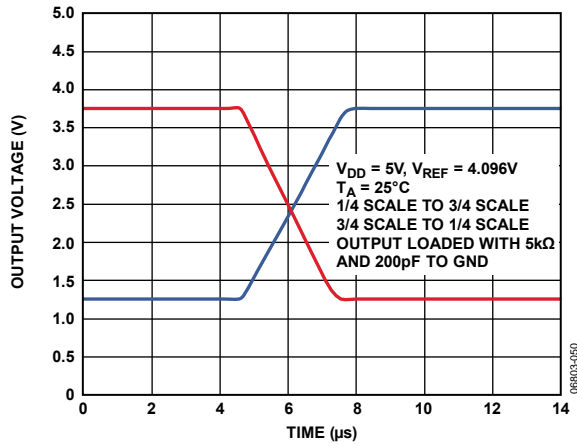

Figure 35. Typical Output Slew Rate

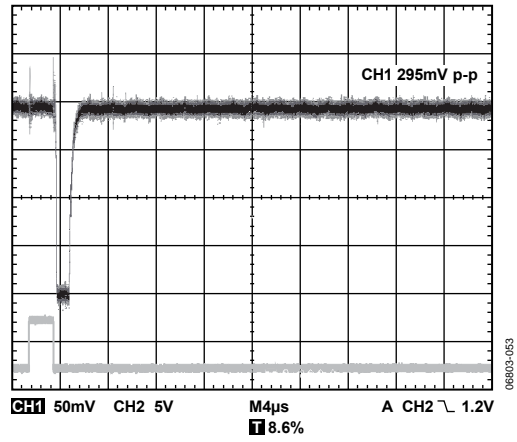

Figure 38. Glitch on Entering Power-Down to Zero Scale, No Load

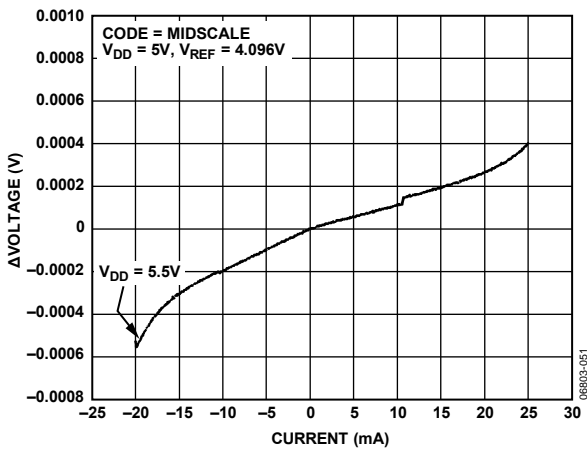

Figure 36. Typical Output Load Regulation

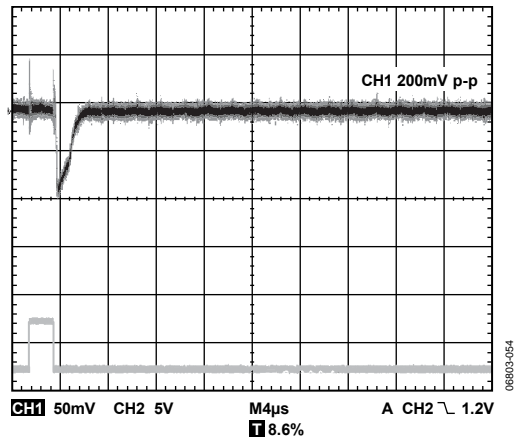

Figure 39. Glitch on Entering Power-Down to Zero Scale, 5 kΩ/200 pF Load

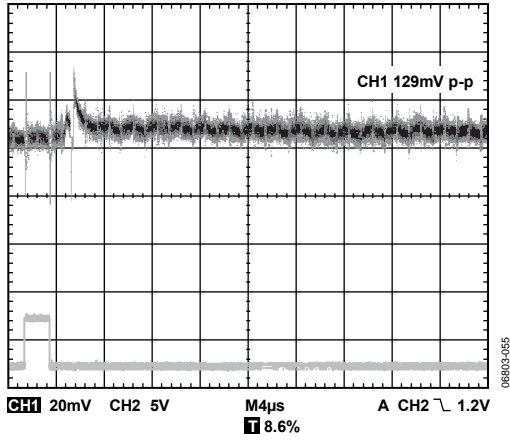

Figure 40. Glitch on Exiting Power-Down from Zero Scale, No load

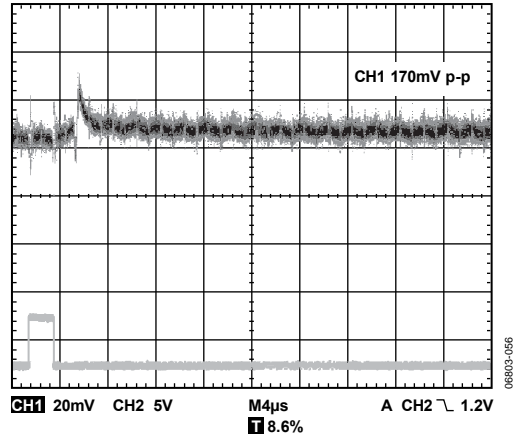

Figure 41. Glitch on Exiting Power-Down from Zero Scale, 5 kΩ/200 pF Load

## TERMINOLOGY

### Relative Accuracy

For the DAC, relative accuracy, or integral nonlinearity (INL), is a measure of the maximum deviation in LSBs from a straight line passing through the endpoints of the DAC transfer function. Figure 4, Figure 5, and Figure 6 show plots of typical INL vs. code.

### Differential Nonlinearity (DNL)

DNL is the difference between the measured change and the ideal 1 LSB change between any two adjacent codes. A specified differential nonlinearity of  $\pm 1$  LSB maximum ensures monotonicity. This DAC is guaranteed monotonic by design. Figure 7, Figure 8 and Figure 9 show plots of typical DNL vs. code.

### Offset Error

Offset error is a measure of the difference between the actual  $V_{OUT}$  and the ideal  $V_{OUT}$ , expressed in millivolts in the linear region of the transfer function. Offset error is measured on the part with Code 512 (AD5064), Code 128 (AD5044), and Code 32 (AD5024) loaded into the DAC register. It can be negative or positive and is expressed in millivolts.

### Gain Error

Gain error is a measure of the span error of the DAC. It is the deviation in slope of the DAC transfer characteristic from the ideal, expressed as a percentage of the full-scale range.

### Offset Error Drift

Offset error drift is a measure of the change in offset error with a change in temperature. It is expressed in microvolts per degree Celsius.

### Gain Temperature Coefficient

Gain error drift is a measure of the change in gain error with changes in temperature. It is expressed in parts per million of full-scale range per degree Celsius.

### Full-Scale Error

Full-scale error is a measure of the output error when full-scale code (0xFFFF) is loaded into the DAC register. Ideally, the output should be  $V_{REF} - 1$  LSB. Full-scale error is expressed as a percentage of the full-scale range. Measured with  $V_{REF} < V_{DD}$ .

### Digital-to-Analog Glitch Impulse

Digital-to-analog glitch impulse is the impulse injected into the analog output when the input code in the DAC register changes state. It is normally specified as the area of the glitch in nanovolt-seconds and is measured when the digital input code is changed by 1 LSB at the major carry transition (0x7FFF to 0x8000). See Figure 27.

### DC Power Supply Rejection Ratio (PSRR)

PSRR indicates how the output of the DAC is affected by changes in the supply voltage. PSRR is the ratio of the change in  $V_{OUT}$  to a change in  $V_{DD}$  for full-scale output of the DAC. It is measured in decibels.  $V_{REF}$  is held at 2.5 V, and  $V_{DD}$  is varied by  $\pm 10\%$ . Measured with  $V_{REF} < V_{DD}$ .

### DC Crosstalk

DC crosstalk is the dc change in the output level of one DAC in response to a change in the output of another DAC. It is measured with a full-scale output change on one DAC (or soft power-down and power-up) while monitoring another DAC kept at midscale. It is expressed in microvolts.

DC crosstalk due to load current change is a measure of the impact that a change in load current on one DAC has to another DAC kept at midscale. It is expressed in microvolts per milliamp.

### Reference Feedthrough

Reference feedthrough is the ratio of the amplitude of the signal at the DAC output to the reference input when the DAC output is not being updated (that is,  $\overline{LDAC}$  is high). It is expressed in decibels.

### Digital Feedthrough

Digital feedthrough is a measure of the impulse injected into the analog output of a DAC from the digital input pins of the device, but it is measured when the DAC is not being written to ( $\overline{SYNC}$  held high). It is specified in nanovolt-seconds and measured with one simultaneous data and clock pulse loaded to the DAC.

### Digital Crosstalk

Digital crosstalk is the glitch impulse transferred to the output of one DAC at midscale in response to a full-scale code change (all 0s to all 1s or vice versa) in the input register of another DAC. It is measured in standalone mode and is expressed in nanovolt-seconds.

### Analog Crosstalk

Analog crosstalk is the glitch impulse transferred to the output of one DAC due to a change in the output of another DAC. It is measured by loading one of the input registers with a full-scale code change (all 0s to all 1s or vice versa) while keeping  $\overline{LDAC}$  high, and then pulsing  $\overline{LDAC}$  low and monitoring the output of the DAC whose digital code has not changed. The area of the glitch is expressed in nanovolt-seconds.



**DAC-to-DAC Crosstalk**

DAC-to-DAC crosstalk is the glitch impulse transferred to the output of one DAC due to a digital code change and subsequent output change of another DAC. This includes both digital and analog crosstalk. It is measured by loading one of the DACs with a full-scale code change (all 0s to all 1s or vice versa) with  $\overline{\text{LDAC}}$  low and monitoring the output of another DAC. The energy of the glitch is expressed in nanovolt-seconds.

**Multiplying Bandwidth**

The amplifiers within the DAC have a finite bandwidth. The multiplying bandwidth is a measure of this. A sine wave on the

reference (with full-scale code loaded to the DAC) appears on the output. The multiplying bandwidth is the frequency at which the output amplitude falls to 3 dB below the input.

**Total Harmonic Distortion (THD)**

Total harmonic distortion is the difference between an ideal sine wave and its attenuated version using the DAC. The sine wave is used as the reference for the DAC, and the THD is a measure of the harmonics present on the DAC output. It is measured in decibels.

# AD5024/AD5044/AD5064

## THEORY OF OPERATION

### DAC SECTION

The AD5024/AD5044/AD5064 are single 12-/14-/16-bit, serial input, voltage output DACs. The parts operate from supply voltages of 4.5 V to 5.5 V. Data is written to the AD5024/AD5044/AD5064 in a 32-bit word format via a 3-wire serial interface. The AD5024/AD5044/AD5064 incorporate a power-on reset circuit that ensures that the DAC output powers up to a known output state. The devices also have a software power-down mode that reduces the typical current consumption to less than 2  $\mu$ A.

Because the input coding to the DAC is straight binary, the ideal output voltage when using an external reference is given by

$$V_{OUT} = V_{REFIN} \times \left( \frac{D}{2^N} \right)$$

where:

$D$  is the decimal equivalent of the binary code that is loaded to the DAC register (0 to 65,535 for the 16-bit AD5064).

$N$  is the DAC resolution.

### DAC ARCHITECTURE

The DAC architecture of the AD5064 consists of two matched DAC sections. A simplified circuit diagram is shown in Figure 42. The four MSBs of the 16-bit data word are decoded to drive 15 switches, E1 to E15. Each of these switches connects one of 15 matched resistors to either GND or the  $V_{REF}$  buffer output. The remaining 12 bits of the data-word drive the S0 to S11 switches of a 12-bit voltage mode R-2R ladder network.

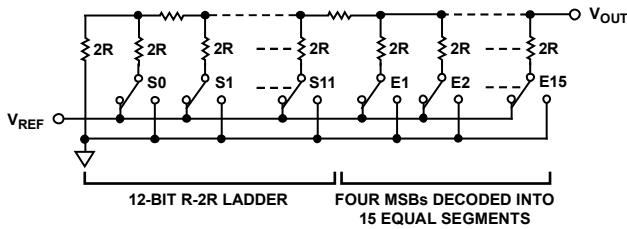

Figure 42. DAC Ladder Structure

### REFERENCE BUFFER

The AD5024/AD5044/AD5064 operate with an external reference. Each DAC has a dedicated voltage reference pin. The reference input pin has an input range of 2.5 V to  $V_{DD}$ . This input voltage is then used to provide a buffered reference for the DAC core.

### OUTPUT AMPLIFIER

The output buffer amplifier can generate rail-to-rail voltages on its output, which gives an output range of 0 V to  $V_{DD}$ . The amplifier is capable of driving a load of 5 k $\Omega$  in parallel with 200 pF to GND. The slew rate is 1.5 V/ $\mu$ s with a  $\frac{1}{4}$  to  $\frac{3}{4}$  scale settling time of 13  $\mu$ s.

### SERIAL INTERFACE

The AD5024/AD5044/AD5064 have a 3-wire serial interface ( $\overline{\text{SYNC}}$ , SCLK, and DIN) that is compatible with SPI, QSPI, and MICROWIRE interface standards as well as most DSPs. See Figure 2 for a timing diagram of a typical write sequence.

### STANDALONE MODE

The write sequence begins by bringing the  $\overline{\text{SYNC}}$  line low. Data from the DIN line is clocked into the 32-bit shift register on the falling edge of SCLK. The serial clock frequency can be as high as 50 MHz, making the AD5024/AD5044/AD5064 compatible with high speed DSPs. On the 32<sup>nd</sup> falling clock edge, the last data bit is clocked in and the programmed function is executed, that is, a change in DAC register contents and/or a change in the mode of operation. At this stage, the  $\overline{\text{SYNC}}$  line can be kept low or be brought high. In either case, it must be brought high for a minimum of 1.9  $\mu$ s (single channel) before the next write sequence so that a falling edge of  $\overline{\text{SYNC}}$  can initiate the next write sequence. Because the  $\overline{\text{SYNC}}$  buffer draws more current when  $V_{IN} = 2.2$  V than it does when  $V_{IN} = 0.8$  V,  $\overline{\text{SYNC}}$  should be idled low between write sequences for even lower power operation of the part. As mentioned previously, however,  $\overline{\text{SYNC}}$  must be brought high again just before the next write sequence.

Table 7. Command Definitions

Command				Description
C3	C2	C1	C0	
0	0	0	0	Write to Input Register n
0	0	0	1	Update DAC Register n
0	0	1	0	Write to Input Register n, update all (software LDAC)
0	0	1	1	Write to and update DAC Channel n
0	1	0	0	Power down/power up DAC
0	1	0	1	Load clear code register
0	1	1	0	Load $\overline{\text{LDAC}}$ register
0	1	1	1	Reset (power-on reset)
1	0	0	0	Reserved
1	0	0	1	Reserved
1	1	1	1	Reserved

Table 8. Address Commands

Address (n)				Selected DAC Channel
A3	A2	A1	A0	
0	0	0	0	DAC A
0	0	0	1	DAC B
0	0	1	0	DAC C
0	0	1	1	DAC D
1	1	1	1	All DACs

## INPUT SHIFT REGISTER

The AD5024/AD5044/AD5064 input shift register is 32 bits wide. The first four bits are don't cares. The next four bits are the command bits, C3 to C0 (see Table 7), followed by the 4-bit DAC address bits, A3 to A0 (see Table 8), and finally the bit data-word. The data-word comprises 12-, 14-, or 16-bit input code followed by 8, 6, or 4 don't care bits for the AD5024/AD5044/AD5064 (see Figure 43, Figure 44, and Figure 45). These data bits are transferred to the DAC register on the 32<sup>nd</sup> falling edge of SCLK.

## SYNC INTERRUPT

In a normal write sequence, the  $\overline{\text{SYNC}}$  line is kept low for at least 32 falling edges of SCLK, and the DAC is updated on the 32<sup>nd</sup> falling edge. However, if  $\overline{\text{SYNC}}$  is brought high before the 32<sup>nd</sup> falling edge, this acts as an interrupt to the write sequence. The shift register is reset, and the write sequence is seen as invalid. Neither an update of the DAC register contents nor a change in the operating mode occurs (see Figure 46).

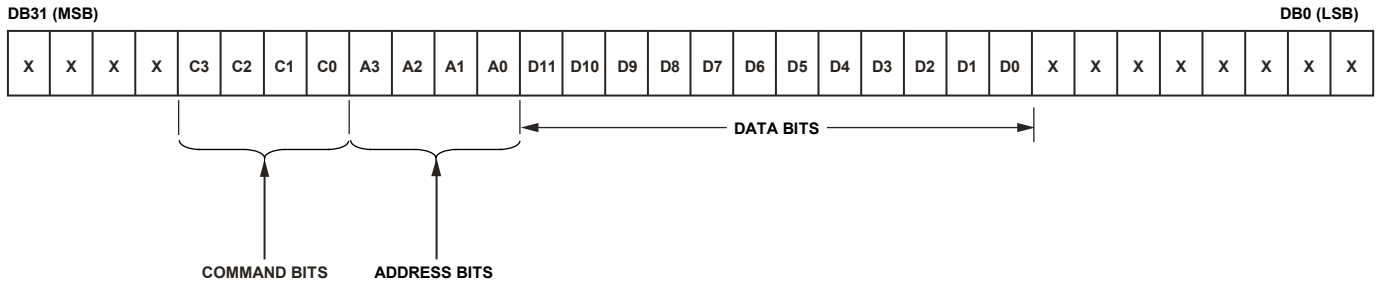

Figure 43. AD5024 Input Register Content

06803-009

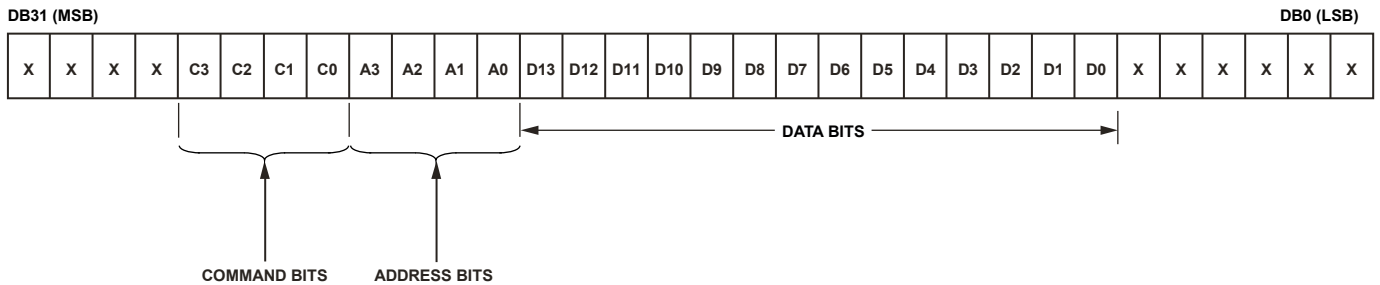

Figure 44. AD5044 Input Register Content

06803-008

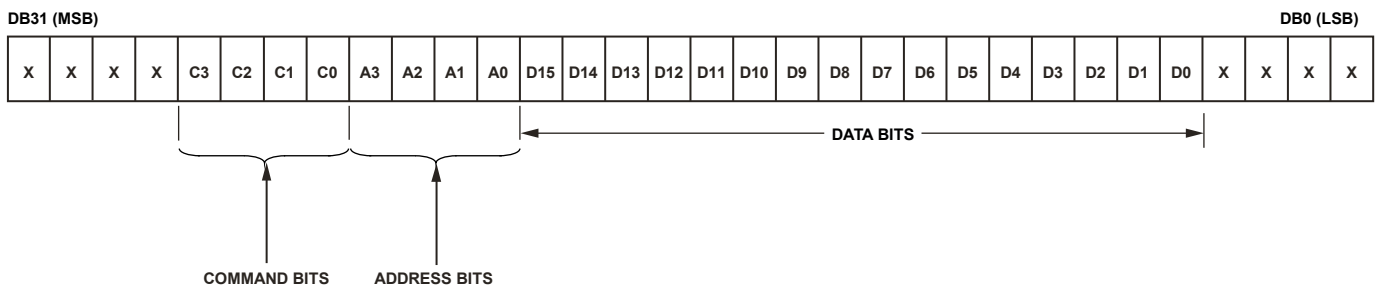

Figure 45. AD5064 Input Register Content

06803-007

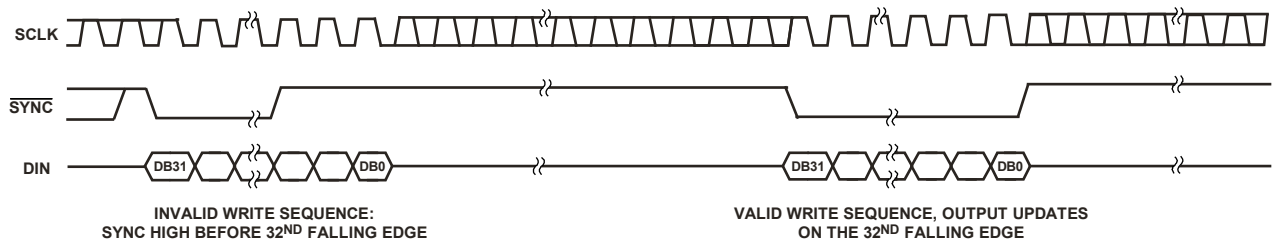

Figure 46.  $\overline{\text{SYNC}}$  Interrupt Facility

06803-010

# AD5024/AD5044/AD5064

## POWER-ON RESET

The AD5024/AD5044/AD5064 contains a power-on reset circuit that controls the output voltage during power-up. By connecting the POR pin low, the AD5024/AD5044/AD5064 output powers up to zero scale. Note that this is outside the linear region of the DAC; by connecting the POR pin high, the AD5024/AD5044/AD5064 output powers up to midscale. The output remains powered up at this level until a valid write sequence is made to the DAC. This is useful in applications where it is important to know the state of the output of the DAC while it is in the process of powering up. There is also a software executable reset function that resets the DAC to the power-on reset code. Command 0111 is designated for this reset function (see Table 7). Any events on  $\overline{\text{LDAC}}$  or  $\overline{\text{CLR}}$  during power-on reset are ignored.

## POWER-DOWN MODES

The AD5024/AD5044/AD5064 contain four separate modes of operation. Command 0100 is designated for the power-down function (see Table 7). These modes are software-programmable by setting two bits, Bit DB9 and Bit DB8, in the control register (Table 9). Table 9 shows how the state of the bits corresponds to the mode of operation of the device. Any or all DACs (DAC D

to DAC A) can be powered down to the selected mode by setting the corresponding four bits (DB3, DB2, DB1, DB0) to 1. See Table 10 for the contents of the input shift register during power-down/power-up operation.

When both Bit DB9 and Bit DB8 in the control register are set to 0, the part works normally with its normal power consumption of 3 mA at 5 V. However, for the three power-down modes, the supply current falls to 0.4  $\mu\text{A}$  at 5 V. Not only does the supply current fall, but the output stage is also internally switched from the output of the amplifier to a resistor network of known values. This has the advantage that the output impedance of the part is known while the part is in power-down mode. There are three different options. The output is connected internally to GND through either a 1 k $\Omega$  or a 100 k $\Omega$  resistor, or it is left open-circuited (three-state). The output stage is illustrated in Figure 47.

The bias generator, output amplifier, resistor string, and other associated linear circuitry are shut down when the power-down mode is activated. However, the contents of the DAC register are unaffected when in power-down. The time to exit power-down is typically 4.5  $\mu\text{s}$  for  $V_{\text{DD}} = 5 \text{ V}$  (see Figure 26).

Table 9. Modes of Operation

DB9	DB8	Operating Mode
0	0	Normal operation
0	1	Power-down modes: 1 k $\Omega$ to GND
1	0	100 k $\Omega$ to GND
1	1	Three-state

Table 10. 32-Bit Input Shift Register Contents for Power-Up/Power-Down Function

MSB										LSB						
DB31 to DB28	DB27	DB26	DB25	DB24	DB23	DB22	DB21	DB20	DB10 to DB19	DB9	DB8	DB4 to DB7	DB3	DB2	DB1	DB0
X	0	1	0	0	X	X	X	X	X	PD1	PD0	X	DAC D	DAC C	DAC B	DAC A
Don't cares	Command bits (C2 to C0)				Address bits (A3 to A0)— don't cares				Don't cares	Power-down mode		Don't cares	Power-down/power-up channel selection—set bit to 1 to select			

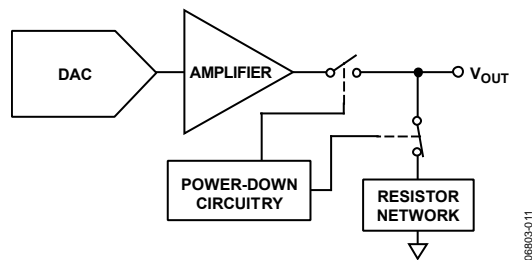

Figure 47. Output Stage During Power-Down

## CLEAR CODE REGISTER

The AD5024/AD5044/AD5064 have a hardware  $\overline{\text{CLR}}$  pin that is an asynchronous clear input. The  $\overline{\text{CLR}}$  input is falling edge sensitive. Bringing the  $\overline{\text{CLR}}$  line low clears the contents of the input register and the  $\overline{\text{DAC}}$  registers to the data contained in the user-configurable  $\overline{\text{CLR}}$  register and sets the analog outputs accordingly (see Table 11). This function can be used in system calibration to load zero scale, midscale, or full scale to all channels together. Note that zero scale and full scale are outside the linear region of the DAC. These clear code values are user-programmable by setting two bits, Bit DB1 and Bit DB0, in the control register (see Table 11). The default setting clears the outputs to 0 V. Command 0101 is designated for loading the clear code register (see Table 7).

The part exits clear code mode on the 32<sup>nd</sup> falling edge of the next write to the part. If  $\overline{\text{CLR}}$  is activated during a write sequence, the write is aborted.

The  $\overline{\text{CLR}}$  pulse activation time, which is the falling edge of  $\overline{\text{CLR}}$  to when the output starts to change, is typically 10.6  $\mu\text{s}$ . If outside the  $\overline{\text{DAC}}$  linear region, it typically takes 10.6  $\mu\text{s}$  after executing  $\overline{\text{CLR}}$  for the output to start changing (see Figure 33).

See Table 12 for contents of the input shift register during the loading clear code register operation.

## $\overline{\text{LDAC}}$ FUNCTION

### Hardware $\overline{\text{LDAC}}$ Pin

The outputs of all  $\overline{\text{DAC}}$ s can be updated simultaneously using the hardware  $\overline{\text{LDAC}}$  pin, as shown in Figure 2.

**Synchronous  $\overline{\text{LDAC}}$ :** After new data is read, the  $\overline{\text{DAC}}$  registers are updated on the falling edge of the 32<sup>nd</sup>  $\overline{\text{SCLK}}$  pulse.  $\overline{\text{LDAC}}$  can be permanently low or pulsed.

**Asynchronous  $\overline{\text{LDAC}}$ :** The outputs are not updated at the same time that the input registers are written to. When  $\overline{\text{LDAC}}$  goes low, the  $\overline{\text{DAC}}$  registers are updated with the contents of the input register.

### Software $\overline{\text{LDAC}}$ Function

Alternatively, the outputs of all  $\overline{\text{DAC}}$ s can be updated simultaneously using the software  $\overline{\text{LDAC}}$  function by writing to Input Register n and updating all  $\overline{\text{DAC}}$  registers. Command 0010 is reserved for this software  $\overline{\text{LDAC}}$  function.

The  $\overline{\text{LDAC}}$  register gives the user extra flexibility and control over the hardware  $\overline{\text{LDAC}}$  pin (see Table 14). Setting the  $\overline{\text{LDAC}}$  bit register (DB0 to DB3) to 0 for a  $\overline{\text{DAC}}$  channel means that this channel's update is controlled by the hardware  $\overline{\text{LDAC}}$  pin.

If this bit is set to 1, this channel updates synchronously; that is, the  $\overline{\text{DAC}}$  register is updated after new data is read, regardless of the state of the hardware  $\overline{\text{LDAC}}$  pin.

It effectively sees the hardware  $\overline{\text{LDAC}}$  pin as being tied low. (See Table 13 for the  $\overline{\text{LDAC}}$  register mode of operation.) This flexibility is useful in applications where the user wants to simultaneously update select channels while the rest of the channels are synchronously updating.

Writing to the  $\overline{\text{DAC}}$  using Command 0110 loads the 4-bit  $\overline{\text{LDAC}}$  register (DB3 to DB0). The default for each channel is 0; that is, the  $\overline{\text{LDAC}}$  pin works normally. Setting the bits to 1 means that the  $\overline{\text{DAC}}$  channel is updated regardless of the state of the  $\overline{\text{LDAC}}$  pin.

## POWER SUPPLY BYPASSING AND GROUNDING

When accuracy is important in a circuit, it is helpful to carefully consider the power supply and ground return layout on the board. The printed circuit board containing the AD5024/AD5044/AD5064 should have separate analog and digital sections. If the AD5024/AD5044/AD5064 is in a system where other devices require an AGND-to-DGND connection, the connection should be made at one point only. This ground point should be as close as possible to the AD5024/AD5044/AD5064.

The power supply to the AD5024/AD5044/AD5064 should be bypassed with 10  $\mu\text{F}$  and 0.1  $\mu\text{F}$  capacitors. The capacitors should physically be as close as possible to the device, with the 0.1  $\mu\text{F}$  capacitor ideally right up against the device. The 10  $\mu\text{F}$  capacitors are the tantalum bead type. It is important that the 0.1  $\mu\text{F}$  capacitor have low effective series resistance (ESR) and low effective series inductance (ESI), such as is typical of common ceramic types of capacitors. This 0.1  $\mu\text{F}$  capacitor provides a low impedance path to ground for high frequencies caused by transient currents due to internal logic switching.

The power supply line should have as large a trace as possible to provide a low impedance path and reduce glitch effects on the supply line. Clocks and other fast switching digital signals should be shielded from other parts of the board by digital ground. Avoid crossover of digital and analog signals, if possible. When traces cross on opposite sides of the board, ensure that they run at right angles to each other to reduce feedthrough effects through the board. The best board layout technique is the microstrip technique, where the component side of the board is dedicated to the ground plane only and the signal traces are placed on the solder side. However, this is not always possible with a 2-layer board.

# AD5024/AD5044/AD5064

Table 11. Clear Code Register

Clear Code Register		Clears to Code
DB1	DB0	
CR1	CR0	
0	0	0x0000
0	1	0x8000
1	0	0xFFFF
1	1	No operation

Table 12. 32-Bit Input Shift Register Contents for Clear Code Function

MSB										LSB	
DB31 to DB28	DB27	DB26	DB25	DB24	DB23	DB22	DB21	DB20	DB2 to DB19	DB1	DB0
X	0	1	0	1	X	X	X	X	X	1/0	1/0
Don't cares	Command bits (C3 to C0)				Address bits (A3 to A0)				Don't cares	Clear code register (CR1 to CR0)	

Table 13.  $\overline{\text{LDAC}}$  Overwrite Definition

Load DAC Register		$\overline{\text{LDAC}}$ Operation
LDAC Bits (DB3 to DB0)	LDAC Pin	
0	1 or 0	Determined by the $\overline{\text{LDAC}}$ pin
1	X—don't care	DAC channels update, overrides the $\overline{\text{LDAC}}$ pin. DAC channels see $\overline{\text{LDAC}}$ as 0.

Table 14. 32-Bit Input Shift Register Contents for  $\overline{\text{LDAC}}$  Overwrite Function

MSB										LSB			
DB31 to DB28	DB27	DB26	DB25	DB24	DB23	DB22	DB21	DB20	DB4 to DB19	DB3	DB2	DB1	DB0
X	0	1	1	0	X	X	X	X	X	DAC D	DAC C	DAC B	DAC A
Don't cares	Command bits (C3 to C0)				Address bits (A3 to A0)—don't cares				Don't cares	Setting $\overline{\text{LDAC}}$ bits to 1 overrides $\overline{\text{LDAC}}$ pin			

## MICROPROCESSOR INTERFACING

### AD5024/AD5044/AD5064 to Blackfin ADSP-BF53x Interface

Figure 48 shows a serial interface between the AD5024/AD5044/AD5064 and the *Blackfin*® ADSP-BF53x microprocessor. The ADSP-BF53x processor family incorporates two dual-channel synchronous serial ports, SPORT1 and SPORT0, for serial and multiprocessor communications. Using SPORT0 to connect to the AD5024/AD5044/AD5064, the setup for the interface is as follows: DT0PRI drives the DIN pin of the AD5024/AD5044/AD5064, and TSCLK0 drives the SCLK of the parts. The SYNC pin is driven from TFS0.

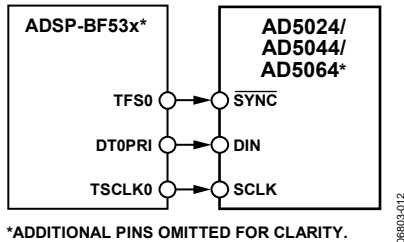

Figure 48. AD5024/AD5044/AD5064 to Blackfin ADSP-BF53x Interface

### AD5024/AD5044/AD5064 to 68HC11/68L11 Interface

Figure 49 shows a serial interface between the AD5024/AD5044/AD5064 and the 68HC11/68L11 microcontroller. SCK of the 68HC11/68L11 drives the SCLK of the AD5024/AD5044/AD5064, and the MOSI output drives the serial data line of the DAC.

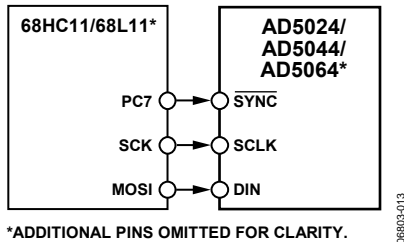

Figure 49. AD5024/AD5044/AD5064 to 68HC11/68L11 Interface

The SYNC signal is derived from a port line (PC7). The setup conditions for correct operation of this interface are as follows: The 68HC11/68L11 is configured with its CPOL bit as 0, and its CPHA bit as 1. When data is being transmitted to the DAC, the SYNC line is taken low (PC7). When the 68HC11/68L11 is configured as described previously, data appearing on the MOSI output is valid on the falling edge of SCK. Serial data from the 68HC11/68L11 is transmitted in 8-bit bytes with only eight falling clock edges occurring in the transmit cycle. Data is transmitted MSB first. To load data to the AD5024/AD5044/AD5064, PC7 is left low after the first eight bits are transferred, and a second serial write operation is performed to the DAC. PC7 is taken high at the end of this procedure.

### AD5024/AD5044/AD5064 to 80C51/80L51 Interface

Figure 50 shows a serial interface between the AD5024/AD5044/AD5064 and the 80C51/80L51 microcontroller. The setup for the interface is as follows: TxD of the 80C51/80L51 drives SCLK of the AD5024/AD5044/AD5064, and RxD drives the serial data line of the part. The SYNC signal is again derived from a bit-programmable pin on the port. In this case, Port Line P3.3 is used. When data is to be transmitted to the AD5024/AD5044/AD5064, P3.3 is taken low. The 80C51/80L51 transmit data in 8-bit bytes only; thus, only eight falling clock edges occur in the transmit cycle. To load data to the DAC, P3.3 is left low after the first eight bits are transmitted, and a second write cycle is initiated to transmit the second byte of data. P3.3 is taken high following the completion of this cycle. The 80C51/80L51 output the serial data in a format that has the LSB first. The AD5024/AD5044/AD5064 must receive data with the MSB first. The 80C51/80L51 transmit routine should take this into account.

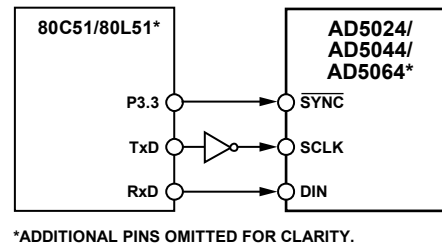

Figure 50. AD5024/AD5044/AD5064 to 80C51/80L51 Interface

### AD5024/AD5044/AD5064 to MICROWIRE Interface

Figure 51 shows an interface between the AD5024/AD5044/AD5064 and any MICROWIRE-compatible device. Serial data is shifted out on the falling edge of the serial clock and is clocked into the AD5024/AD5044/AD5064 on the rising edge of the SCLK.

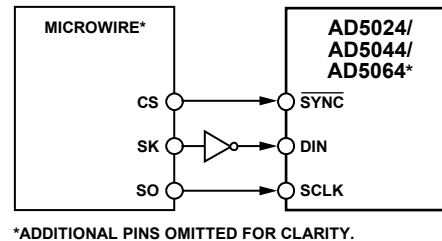

Figure 51. AD5024/AD5044/AD5064 to MICROWIRE Interface

## APPLICATIONS

### USING A REFERENCE AS A POWER SUPPLY

Because the supply current required by the AD5024/AD5044/AD5064 is extremely low, an alternative option is to use a voltage reference to supply the required voltage to the parts (see Figure 52). This is especially useful if the power supply is quite noisy or if the system supply voltages are at some value other than 5 V (for example, 15 V). The voltage reference outputs a steady supply voltage for the AD5024/AD5044/AD5064. If the low dropout REF195 is used, it must supply 3 mA of current to the AD5024/AD5044/AD5064, with no load on the output of the DAC. When the DAC output is loaded, the REF195 also needs to supply the current to the load. The total current required (with a 5 kΩ load on the DAC output) is

$$3 \text{ mA} + (5 \text{ V}/5 \text{ k}\Omega) = 4 \text{ mA}$$

The load regulation of the REF195 is typically 2 ppm/mA, which results in a 3 ppm (15 μV) error for the 4 mA current drawn from it. This corresponds to a 0.196 LSB error.

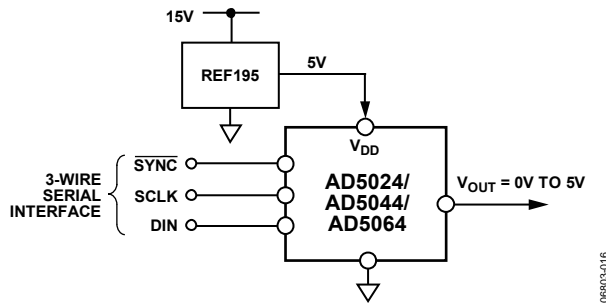

Figure 52. REF195 as Power Supply to the AD5024/AD5044/AD5064

### BIPOLAR OPERATION

The AD5024/AD5044/AD5064 have been designed for single-supply operation, but a bipolar output range is also possible using the circuit shown in Figure 53. The circuit gives an output voltage range of ±5 V. Rail-to-rail operation at the amplifier output is achievable using an AD820 or an OP295 as the output amplifier.

Assuming  $V_{DD} = V_{REF}$ , the output voltage for any input code can be calculated as follows:

$$V_{OUT} = \left[ V_{DD} \times \left( \frac{D}{65,536} \right) \times \left( \frac{R1 + R2}{R1} \right) - V_{DD} \times \left( \frac{R2}{R1} \right) \right]$$

where  $D$  represents the input code in decimal (0 to 65,535).

With  $V_{DD} = 5 \text{ V}$ ,  $R1 = R2 = 10 \text{ k}\Omega$ ,

$$V_{OUT} = \left( \frac{10 \times D}{65,536} \right) - 5 \text{ V}$$

This is an output voltage range of ±5 V, with 0x0000 corresponding to a -5 V output, and 0xFFFF corresponding to a +5 V output.

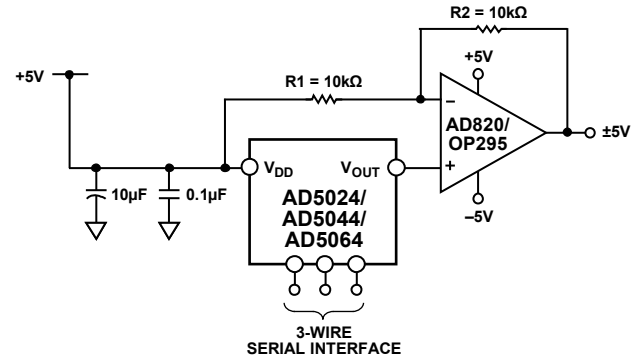

Figure 53. Bipolar Operation

### USING THE AD5024/AD5044/AD5064 WITH A GALVANICALLY ISOLATED INTERFACE

In process control applications in industrial environments, it is often necessary to use a galvanically isolated interface to protect and isolate the controlling circuitry from any hazardous common-mode voltages that can occur in the area where the DAC is functioning. *iCoupler*® provides isolation in excess of 2.5 kV. The AD5024/AD5044/AD5064 use a 3-wire serial logic interface, so the ADuM1300 three-channel digital isolator provides the required isolation (see Figure 54). The power supply to the part also needs to be isolated, which is done by using a transformer. On the DAC side of the transformer, a 5 V regulator provides the 5 V supply required for the AD5024/AD5044/AD5064.

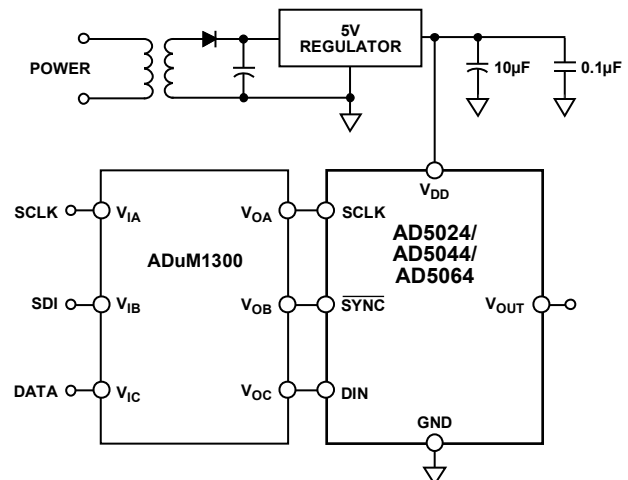
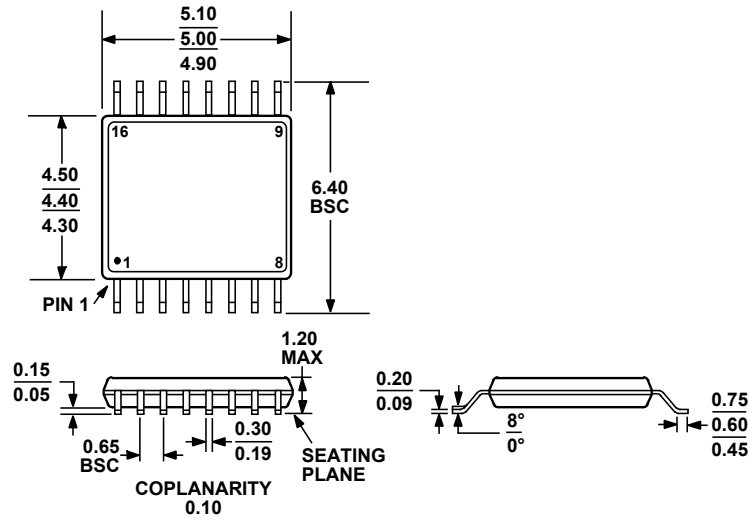

Figure 54. AD5024/AD5044/AD5064 with a Galvanically Isolated Interface



## OUTLINE DIMENSIONS



COMPLIANT TO JEDEC STANDARDS MO-153-AB

Figure 55. 16-Lead Thin Shrink Small Outline Package [TSSOP]  
(RU-16)

Dimensions shown in millimeters

## ORDERING GUIDE

Model	Temperature Range	Accuracy	Resolution	Package Description	Package Option
AD5064BRUZ <sup>1</sup>	-40°C to +105°C	±1 LSB INL	16 Bits	16-Lead TSSOP	RU-16
AD5064BRUZ-REEL7 <sup>1</sup>	-40°C to +105°C	±1 LSB INL	16 Bits	16-Lead TSSOP	RU-16
AD5044BRUZ <sup>1</sup>	-40°C to +105°C	±1 LSB INL	14 Bits	16-Lead TSSOP	RU-16
AD5044BRUZ-REEL7 <sup>1</sup>	-40°C to +105°C	±1 LSB INL	14 Bits	16-Lead TSSOP	RU-16
AD5024BRUZ <sup>1</sup>	-40°C to +105°C	±1 LSB INL	12 Bits	16-Lead TSSOP	RU-16
AD5024BRUZ-REEL7 <sup>1</sup>	-40°C to +105°C	±1 LSB INL	12 Bits	16-Lead TSSOP	RU-16

<sup>1</sup> Z = RoHS Compliant Part.

**AD5024/AD5044/AD5064**

**NOTES**

**NOTES**

**NOTES**