

# NEC's CW InGaAsP MQW DFB LASER DIODE MODULE FOR DWDM APPLICATIONS (10 mW MIN)

## NX8563 SERIES

### FEATURES

- **OUTPUT POWER:**  
P<sub>f</sub> = 10 mW MIN
- **INTERNAL THERMOELECTRIC COOLER AND ISOLATOR**
- **HERMETICALLY SEALED 14-PIN BUTTERFLY PACKAGE**
- **POLARIZATION MAINTAIN FIBER PIGTAIL**
- **AVAILABLE FOR DWDM WAVELENGTHS BASED ON ITU-T RECOMMENDATIONS (100 GHz GRID) REFER TO THE ORDERING INFORMATION**

### DESCRIPTION

NEC's NX8563 Series are a 1550 nm Multiple Quantum Well (MQW) structured Distributed Feed-Back (DFB) laser diode with Polarization Maintain Fiber (PMF). This device is designed as Continuous Wave (CW) light source and ideal for optical transmission systems in which external modulators are used.

This device is available for Dense Wavelength Division Multiplexing (DWDM) wave lengths based on ITU-T recommendations, enabling a wide range of applications.

### ELECTRO-OPTICAL CHARACTERISTICS (T<sub>LD</sub> = T<sub>SET</sub>, T<sub>C</sub> = -20 to +70°C)

PART NUMBER			NX8563 Series		
SYMBOLS	PARAMETERS AND CONDITIONS	UNITS	MIN	TYP	MAX
T <sub>SET</sub>	Laser Set Temperature	°C	20		35
V <sub>F</sub>	Forward Voltage, P <sub>f</sub> = 10 mW	V		1.2	1.5
I <sub>F</sub>	Forward Current, P <sub>f</sub> = 10 mW	mA		70	125
I <sub>TH</sub>	Threshold Current	mA		20	40
P <sub>f</sub>	Optical Output Power from Fiber, I <sub>F</sub> = 125 mA, T <sub>LD</sub> = T <sub>SET</sub>	mW	10		
λ <sub>p</sub>	Peak Emission Wavelength <sup>1</sup> , P <sub>f</sub> = 10 mW, CW, T <sub>LD</sub> = T <sub>SET</sub>	nm	1527.99	ITU-T <sup>1</sup>	1611.78
Δν	Spectral Line Width, P <sub>f</sub> = 10 mW, CW, 3 dB down	MHz		1	2
SMSR	Side Mode Suppression Ratio, P <sub>f</sub> = 10 mW, CW	dB	33	45	
RIN	Relative Intensity Noise, P <sub>f</sub> = 10 mW, 20 MHz to 3 GHz	dB/Hz			-150
ext	Polarization Extinction Ratio <sup>2</sup> , P <sub>f</sub> = 10 mW, CW	dB	20		

Notes:

1. Available for DWDM based on ITU-T recommendations. Please refer to Ordering Information.
2. Polarization state of LD is aligned parallel to the slow axis.

**ELECTRO-OPTICAL CHARACTERISTICS** (Applicable to Monitor PD: TLD = TSET, Tc = -20 to +70°C)

PART NUMBER			NX8563 Series		
SYMBOLS	PARAMETERS AND CONDITIONS	UNITS	MIN	TYP	MAX
I <sub>m</sub>	Monitor Current, P <sub>f</sub> = 10 mW, V <sub>R</sub> = 5 V	μA	100		2000
I <sub>D</sub>	Dark Current, V <sub>R</sub> = 5 V	nA			10
γ <sup>1</sup>	Tracking Error, I <sub>m</sub> = const.	dB			0.5

Note:  
 1.  $\gamma = \left| 10 \log \frac{P_f}{10 \text{ mW}} \right|$

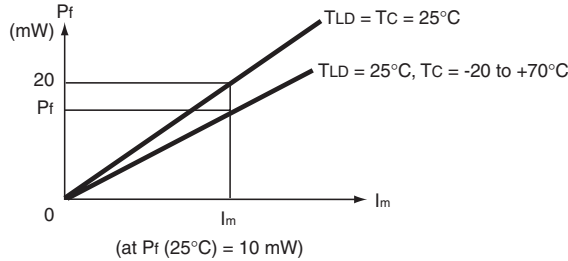

**ELECTRO-OPTICAL CHARACTERISTICS** (Applicable to Thermistor and TEC: TLD = TSET, Tc = -20 to +70°C)

PART NUMBER			NX8563 Series		
SYMBOLS	PARAMETERS AND CONDITIONS	UNITS	MIN	TYP	MAX
R	Thermistor Resistance, TLD = 25°C	kΩ	9.5	10.0	10.5
B	B Constant	K	3350	3450	3550
I <sub>c</sub>	Cooler Current, ΔT = 70 - T <sub>set</sub> , P <sub>f</sub> = 10 mW	A			1
V <sub>c</sub>	Cooler Voltage, ΔT = 70 - T <sub>set</sub> , P <sub>f</sub> = 10 mW	V			2

**ABSOLUTE MAXIMUM RATINGS<sup>1</sup>**

(T<sub>c</sub> = 25°C, unless otherwise specified)

SYMBOLS	PARAMETERS	UNITS	RATINGS
I <sub>F</sub>	Forward Current of LD	mA	300
V <sub>R</sub>	Reverse Voltage of LD	V	2.0
I <sub>F</sub>	Forward Current of PD	mA	10
V <sub>R</sub>	Reverse Voltage of PD	V	20
T <sub>c</sub>	Operating Case Temperature	°C	-20 to +70
T <sub>STG</sub>	Storage Temperature	°C	-40 to +85
T <sub>SLD</sub>	Lead Soldering Temperature (10 s)	°C	260

Note:

1. Operation in excess of any one of these parameters may result in permanent damage.

**TYPICAL PERFORMANCE CURVES** (TC = TSET unless otherwise specified)

**LONGITUDINAL MODE**

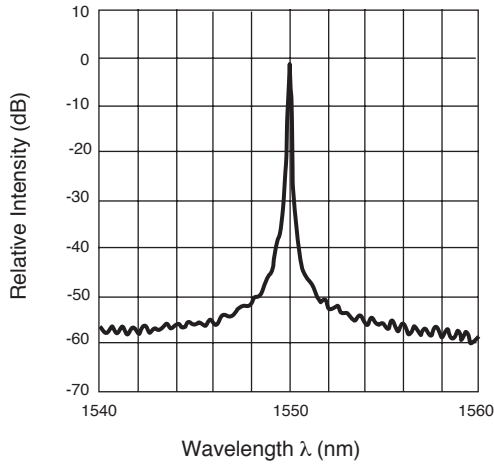

**OPTICAL OUTPUT POWER FROM FIBER vs. FORWARD CURRENT**

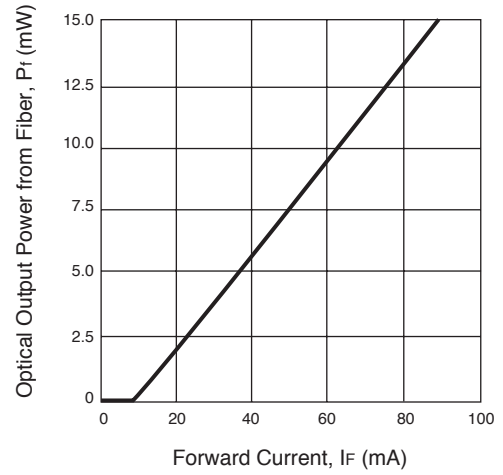

**FORWARD CURRENT vs. FORWARD VOLTAGE**

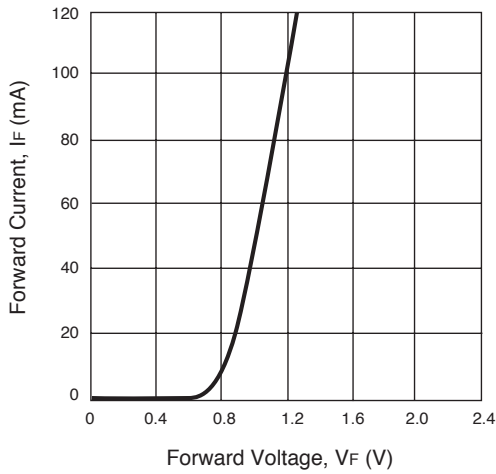

**OPTICAL OUTPUT POWER FROM FIBER vs. MONITOR CURRENT**

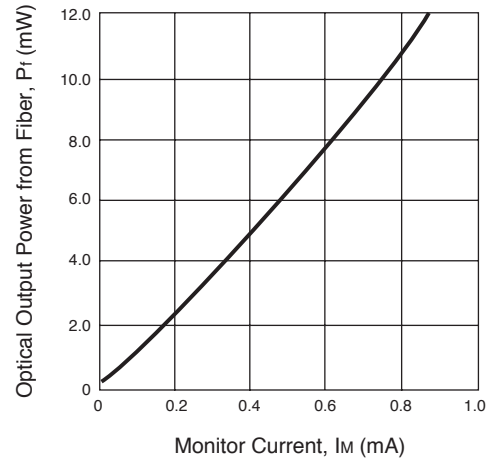

**THERMISTOR RESISTANCE vs. AMBIENT TEMPERATURE**

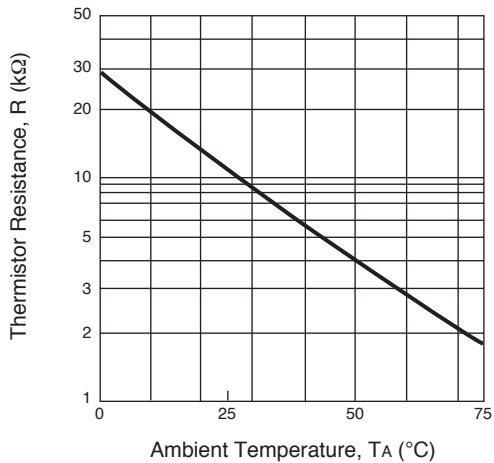

# NX8563 SERIES

## ORDERING INFORMATION

PART NUMBER	PACKAGE
NX8563-AZ*	14-Pin Butterfly Package

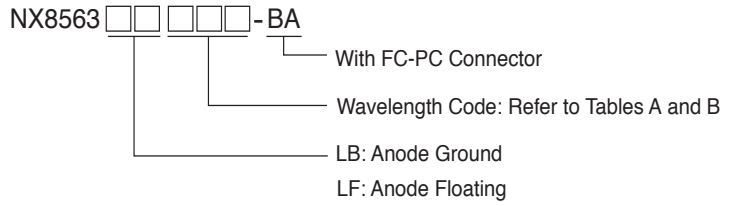

**\*NOTE:**

Please refer to the last page of this data sheet, "Compliance with EU Directives" for Pb-Free RoHS Compliance Information.

**TABLE A: DWDM Wavelength based on ITU-T Recommendations (@T<sub>LD</sub> = Tset)**

Wavelength code	ITU-T <sup>1</sup> Wavelength (nm)	Frequency (THz)	Wavelength code	ITU-T <sup>1</sup> Wavelength (nm)	Frequency (THz)
287	1528.77	196.10	493	1549.31	193.50
295	1529.55	196.00	501	1550.11	193.40
303	1530.33	195.90	509	1550.91	193.30
311	1531.11	195.80	517	1551.72	193.20
318	1531.89	195.70	525	1552.52	193.10
326	1532.68	195.60	533	1553.32	193.00
334	1533.46	195.50	541	1554.13	192.90
342	1534.25	195.40	549	1554.94	192.80
350	1535.03	195.30	557	1555.74	192.70
358	1535.82	195.20	565	1556.55	192.60
366	1536.60	195.10	573	1557.36	192.50
373	1537.39	195.00	581	1558.17	192.40
381	1538.18	194.90	589	1558.98	192.30
389	1538.97	194.80	597	1559.79	192.20
397	1539.76	194.70	606	1560.60	192.10
405	1540.55	194.60	614	1561.41	192.00
413	1541.34	194.50	622	1562.23	191.90
421	1542.14	194.40	630	1563.04	191.80
429	1542.93	194.30	638	1563.86	191.70
437	1543.73	194.20	646	1564.67	191.60
445	1544.52	194.10	654	1565.49	191.50
453	1545.32	194.00	663	1566.31	191.40
461	1546.11	193.90	671	1567.13	191.30
469	1546.91	193.80	679	1567.95	191.20
477	1547.71	193.70	687	1568.77	191.10
485	1548.51	193.60			

**Note:**

1. The Value which omitted and computed the 3rd place below the decimal point.

**TABLE B: DWDM Wavelength based on ITU-T Recommendations (@T<sub>LD</sub> = T<sub>set</sub>)**

Wavelength code	ITU-T <sup>1</sup> Wavelength (nm)	Frequency (THz)	Wavelength code	ITU-T <sup>1</sup> Wavelength (nm)	Frequency (THz)
695	1569.59	191.00	912	1591.25	188.40
704	1570.41	190.90	921	1592.10	188.30
712	1571.23	190.80	929	1592.94	188.20
720	1572.06	190.70	937	1593.79	188.10
728	1572.88	190.60	946	1594.64	188.00
737	1573.71	190.50	954	1595.48	187.90
745	1574.54	190.40	963	1596.33	187.80
753	1575.36	190.30	971	1597.18	187.70
761	1576.19	190.20	980	1598.04	187.60
770	1577.02	190.10	988	1598.89	187.50
778	1577.85	190.00	997	1599.74	187.40
786	1578.68	189.90	6006	1600.60	187.30
795	1579.51	189.80	6014	1601.45	187.20
803	1580.35	189.70	6023	1602.31	187.10
811	1581.18	189.60	6031	1603.16	187.00
820	1582.01	189.50	6040	1604.02	186.90
828	1582.85	189.40	6048	1604.88	186.80
836	1583.69	189.30	6057	1605.74	186.70
845	1584.52	189.20	6066	1606.60	186.60
853	1585.36	189.10	6074	1607.46	186.50
862	1586.20	189.00	6083	1608.32	186.40
870	1587.04	188.90	6091	1609.19	186.30
878	1587.88	188.80	6100	1610.05	186.20
887	1588.72	188.70	6109	1610.92	186.10
895	1589.56	188.60	6117	1611.78	186.00
4904	1590.41	188.50			

Note:

1. The Value which omitted and computed the 3rd place below the decimal point.

# NX8563 SERIES

## OUTLINE DIMENSIONS (Units in mm)

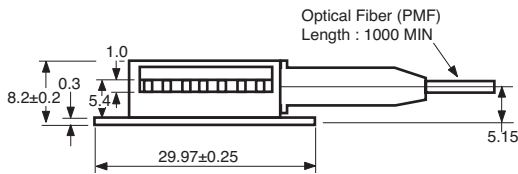
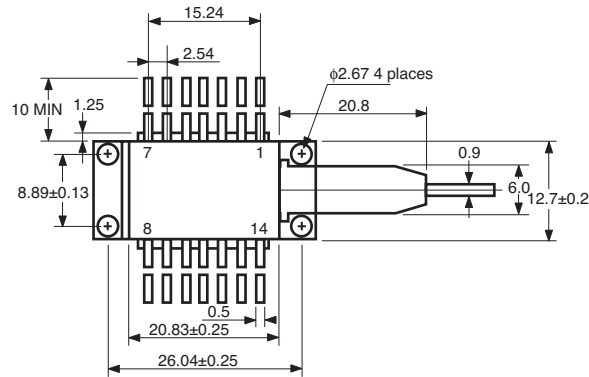

**NX8563LB  
TOP VIEW**

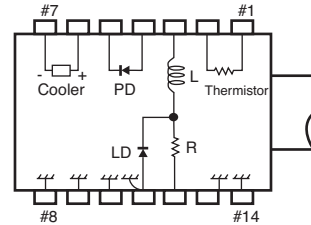

**PIN CONNECTIONS**

PIN No.	FUNCTION	PIN No.	FUNCTION
1	THERMISTOR	8	GND
2	THERMISTOR	9	GND
3	BIAS	10	GND
4	PD ANODE	11	GND, LD ANODE
5	PD CATHODE,	12	SIGNAL INPUT
6	COOLER ANODE	13	GND
7	COOLER CATHODE	14	GND

**NX8563LF  
TOP VIEW**

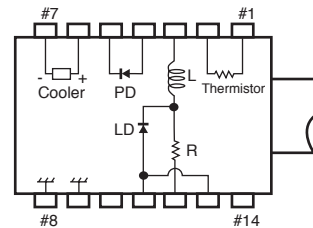

**PIN CONNECTIONS**

PIN No.	FUNCTION	PIN No.	FUNCTION
1	THERMISTOR	8	GND
2	THERMISTOR	9	GND
3	LD Cathode	10	PD ( $\lambda_p$ ) ANODE
4	PD (Pi) ANODE	11	LD ANODE
5	PD CATHODE	12	LD CATHODE
6	COOLER ANODE	13	LD ANODE
7	COOLER CATHODE	14	NC

## OPTICAL FIBER DIMENSIONS (Units in mm)

Parameter	Unit	Specification
Outer Diameter	mm	0.9±0.1
Minimum Fiber Bending Radius	mm	30
Fiber Length	mm	1000 MIN

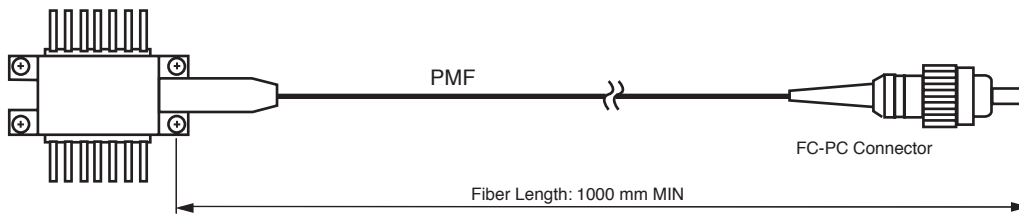

### Life Support Applications

These NEC products are not intended for use in life support devices, appliances, or systems where the malfunction of these products can reasonably be expected to result in personal injury. The customers of CEL using or selling these products for use in such applications do so at their own risk and agree to fully indemnify CEL for all damages resulting from such improper use or sale.

**CEL** California Eastern Laboratories, Your source for NEC RF, Microwave, Optoelectronic, and Fiber Optic Semiconductor Devices.

4590 Patrick Henry Drive • Santa Clara, CA 95054-1817 • (408) 988-3500 • FAX (408) 988-0279 • [www.cel.com](http://www.cel.com)

DATA SUBJECT TO CHANGE WITHOUT NOTICE

04/02/2003

Subject: Compliance with EU Directives

CEL certifies, to its knowledge, that semiconductor and laser products detailed below are compliant with the requirements of European Union (EU) Directive 2002/95/EC Restriction on Use of Hazardous Substances in electrical and electronic equipment (RoHS) and the requirements of EU Directive 2003/11/EC Restriction on Penta and Octa BDE.

CEL Pb-free products have the same base part number with a suffix added. The suffix –A indicates that the device is Pb-free. The –AZ suffix is used to designate devices containing Pb which are exempted from the requirement of RoHS directive (\*). In all cases the devices have Pb-free terminals. All devices with these suffixes meet the requirements of the RoHS directive.

This status is based on CEL’s understanding of the EU Directives and knowledge of the materials that go into its products as of the date of disclosure of this information.

Restricted Substance per RoHS	Concentration Limit per RoHS (values are not yet fixed)	Concentration contained in CEL devices	
		-A	-AZ
Lead (Pb)	< 1000 PPM	Not Detected	(*)
Mercury	< 1000 PPM	Not Detected	
Cadmium	< 100 PPM	Not Detected	
Hexavalent Chromium	< 1000 PPM	Not Detected	
PBB	< 1000 PPM	Not Detected	
PBDE	< 1000 PPM	Not Detected	

If you should have any additional questions regarding our devices and compliance to environmental standards, please do not hesitate to contact your local representative.

Important Information and Disclaimer: Information provided by CEL on its website or in other communications concerning the substance content of its products represents knowledge and belief as of the date that it is provided. CEL bases its knowledge and belief on information provided by third parties and makes no representation or warranty as to the accuracy of such information. Efforts are underway to better integrate information from third parties. CEL has taken and continues to take reasonable steps to provide representative and accurate information but may not have conducted destructive testing or chemical analysis on incoming materials and chemicals. CEL and CEL suppliers consider certain information to be proprietary, and thus CAS numbers and other limited information may not be available for release.

In no event shall CEL’s liability arising out of such information exceed the total purchase price of the CEL part(s) at issue sold by CEL to customer on an annual basis.

See CEL Terms and Conditions for additional clarification of warranties and liability.