

## General Description

The AAT3104 is a charge-pump based, current-source white LED driver capable of driving one to four LEDs up to 30mA, each. It automatically switches between 1x mode and 2x mode to maintain the highest efficiency and optimal LED current accuracy and matching.

The AAT3104 charge pump's 1x mode (bypass mode) has very low resistance allowing LED current regulation to be maintained with input supply voltage approaching the LED forward voltage.

LED brightness is controlled using AnalogicTech's patented S<sup>2</sup>Cwire™ single wire interface. The AAT3104 is available in a 2x2mm 10-lead SC70JW-10 package.

## Features

- Drives up to 4 LEDs at up to 31mA each
- Automatic Switching Between 1x and 2x Modes
- 1MHz Switching Frequency
- Linear LED Output Current Control
- Single-wire, S<sup>2</sup>Cwire Interface  
AAT3104-1: 16-step  
AAT3104-2: 32-step
- ±10% LED Output Current Accuracy
- ±3% LED Output Current Matching
- Low-current Shutdown Mode
- Built-in Thermal Protection
- Automatic Soft-start
- Available in 2x2mm SC70JW-10 Package

## Applications

- Cordless Phone Handsets
- Digital Cameras
- Mobile Phone Handsets
- MP3 and PMP Players

## Typical Application

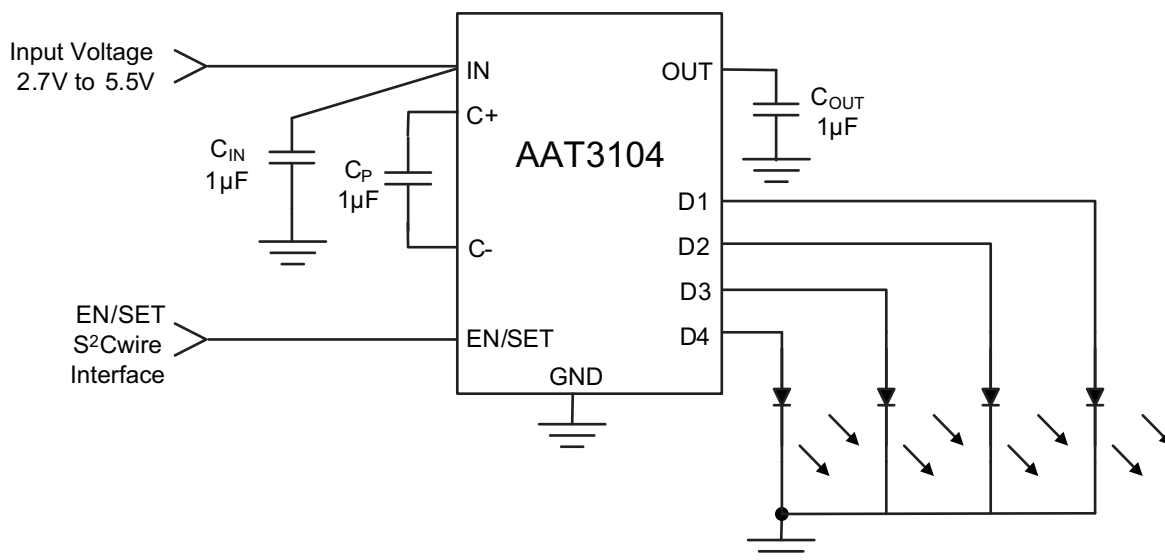

## Pin Descriptions

| Pin# | Name   | Description  |
|------|--------|--|
| 1    | D2     | LED2 Current Source Output. D2 is the output of LED2 current source. Connect LED2's anode to D2 and its cathode to GND.  |
| 2    | D1     | LED1 Current Source Output. D1 is the output of LED1 current source. Connect LED1's anode to D1 and its cathode to GND.  |
| 3    | OUT    | Charge Pump Output. OUT is the output of the charge pump. Bypass OUT to GND with a 1 $\mu$ F or larger ceramic capacitor.  |
| 4    | C-     | Charge Pump Capacitor Negative Node.   |
| 5    | C+     | Charge Pump Capacitor Positive Node. Connect a 1 $\mu$ F ceramic capacitor between C+ and C-.  |
| 6    | GND    | Analog Ground. Connect this pin to the system's analog ground plane.   |
| 7    | EN/SET | LED Enable and serial control input. EN/SET is the ON/OFF control for the LED and the S <sup>2</sup> Cwire digital input for the AAT3104-1/-2 to control serially the LED brightness according to the maximum current. |
| 8    | IN     | Power source input. Connect IN to the power source, typically the battery. Bypass IN to GND with a 1 $\mu$ F or larger ceramic capacitor.  |
| 9    | D4     | LED4 Current Source Output. D4 is the output of LED4 current source. Connect LED4's anode to D4 and its cathode to GND.  |
| 10   | D3     | LED3 Current Source Output. D3 is the output of LED3 current source. Connect LED3's anode to D3 and its cathode to GND.  |

## Pin Configuration

SC70JW-10  
(Top View)

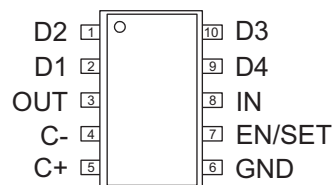

## Absolute Maximum Ratings<sup>1</sup>

| Symbol  | Description   | Value                  | Units |
|---|---|------------------------|-------|
| $V_{IN}, V_{OUT}, V_{C+}, V_{C-}, V_{D1...4}$ | IN, C+, C-, OUT, D1, D2, D3, and D4 Pin Voltages to GND | -0.3 to 6.0            | V     |
| $V_{EN/SET}$                                  | EN/SET Pin Voltage to GND                               | -0.3 to $V_{IN} + 0.3$ | V     |
| $T_S$   | Storage Temperature Range                               | -65 to 150             | °C    |
| $T_J$   | Operating Junction Temperature Range                    | -40 to 150             | °C    |
| $T_{LEAD}$                                    | Maximum Soldering Temperature (at leads, 10 sec)        | 300                    | °C    |

## Thermal Information

| Symbol        | Description                               | Value | Units |
|---------------|---|-------|-------|
| $P_D$         | Maximum Power Dissipation <sup>2, 3</sup> | 625   | mW    |
| $\theta_{JA}$ | Maximum Thermal Resistance <sup>3</sup>   | 160   | °C/W  |

1. Stresses above those listed in Absolute Maximum Ratings may cause permanent damage to the device. Functional operation at conditions other than the operating conditions specified is not implied. Only one Absolute Maximum Rating should be applied at any one time.

2. Mounted on an FR4 circuit board.

3. Derate 6.25mW/°C above 40°C ambient temperature.

## Electrical Characteristics<sup>1</sup>

IN = EN = 3.6V, C<sub>IN</sub> = 1μF, C<sub>OUT</sub> = 1μF, C<sub>1</sub> = 1μF, T<sub>A</sub> = -40°C to 85°C unless otherwise noted. Typical values are at T<sub>A</sub> = 25°C.

| Symbol   | Description                                  | Conditions  | Min | Typ | Max  | Units |
|--|--|---|-----|-----|------|-------|
| <b>Input Power Supply</b>                                  |  |   |     |     |      |       |
| V <sub>IN</sub>  | Input Voltage Range                          |   | 2.7 |     | 5.5  | V     |
| I <sub>q</sub>   | Quiescent Current                            | IN = 5.5V, EN = IN, V <sub>D1</sub> = V <sub>D2</sub> = V <sub>D3</sub> = 0V  |     | 6   |      | mA    |
| I <sub>IN</sub>  | No Load Operating Current                    | IN = 5.5V, EN = IN, I <sub>D1</sub> = I <sub>D2</sub> = I <sub>D3</sub> = I <sub>D4</sub> = FS, V <sub>D1</sub> = V <sub>D2</sub> = V <sub>D3</sub> = V <sub>D4</sub> = IN - 1.5V, Exclude I <sub>DN</sub> current, 1x mode |     | 3.5 |      | mA    |
|  |  | Operating, I <sub>D1</sub> = I <sub>D2</sub> = I <sub>D3</sub> = I <sub>D4</sub> = OPEN, 2x mode  |     | 6   |      | mA    |
| I <sub>IN(SHDN)</sub>                                      | Input Shutdown Current                       | EN/SET = GND  |     |     | 1    | μA    |
| <b>Charge Pump Section</b>                                 |  |   |     |     |      |       |
| I <sub>OUT</sub>   | OUT Maximum Output Current                   |   |     | 150 |      | mA    |
| V <sub>OUT</sub>   | Charge Pump Output Voltage                   | When charge pump is on  |     | 5   |      | V     |
| f <sub>OSC</sub>   | Charge Pump Oscillator Frequency             |   | 0.6 | 0.8 | 1.05 | MHz   |
| V <sub>IN(TH)</sub>  | Charge Pump Mode Hysteresis                  | I <sub>D1</sub> = I <sub>D2</sub> = I <sub>D3</sub> = I <sub>D4</sub> = 30mA  |     | 150 | 250  | mV    |
| t <sub>OUT</sub>   | LED Output Current Start-up Time             | EN/SET = IN   |     | 190 |      | μs    |
| <b>AAT3104-1/-2: LED Current Source Outputs</b>            |  |   |     |     |      |       |
| I <sub>D(MAX)</sub>  | D1 - D4 Current Accuracy (AAT3104-1 only)    | DATA = 1, V <sub>IN</sub> - V <sub>F</sub> = 1.5V   | 27  | 30  | 33   | mA    |
| I <sub>D(MAX)</sub>  | D1 - D4 Current Accuracy (AAT3104-2 only)    | DATA = 1, V <sub>IN</sub> - V <sub>F</sub> = 1.5V   | 28  | 31  | 34   | mA    |
| ΔI <sub>D(MAX)</sub>                                       | D1 - D4 Current Matching                     | DATA = 1, V <sub>IN</sub> - V <sub>F</sub> = 1.5V   | -3  |     | +3   | %     |
| I <sub>D(DATA15)</sub>                                     | D1 - D4 Current Accuracy (AAT3104-1 only)    | DATA = 15, V <sub>IN</sub> - V <sub>F</sub> = 1.5V  | 1.6 | 2.0 | 2.4  | mA    |
| I <sub>D(DATA29)</sub>                                     | D1 - D4 Current Accuracy (AAT3104-2 only)    | DATA = 29, V <sub>IN</sub> - V <sub>F</sub> = 1.5V  | 1.6 | 2.0 | 2.4  | mA    |
| V <sub>D(TH)</sub>   | D1- D4 Charge Pump Mode Transition Threshold | I <sub>D1</sub> = I <sub>D2</sub> = I <sub>D3</sub> = I <sub>D4</sub> = 30mA, V <sub>IN</sub> - V <sub>D1</sub> is measured   |     | 380 |      | mV    |
|  |  | I <sub>D1</sub> = I <sub>D2</sub> = I <sub>D3</sub> = I <sub>D4</sub> = 20mA, V <sub>IN</sub> - V <sub>D1</sub> is measured   |     | 350 |      | mV    |
| <b>AAT3104-1/-2: EN/SET and S<sup>2</sup>Cwire Control</b> |  |   |     |     |      |       |
| V <sub>ENH</sub>   | EN/SET Input High Threshold Voltage          |   | 1.4 |     |      | V     |
| V <sub>ENL</sub>   | EN/SET Input Low Threshold Voltage           |   |     |     | 0.4  | V     |
| I <sub>EN(LKG)</sub>                                       | EN/SET Input Leakage Current                 | EN/SET = IN = 5V  | -1  |     | 1    | μA    |
| t <sub>EN(SET)(OFF)</sub>                                  | EN/SET Input OFF Timeout                     |   |     |     | 500  | μs    |
| t <sub>EN(SET)(LAT)</sub>                                  | EN/SET Input Latch Timeout                   |   |     |     | 500  | μs    |
| t <sub>EN(SET)(LOW)</sub>                                  | EN/SET Input Low Time                        |   | 0.3 |     | 75   | μs    |
| t <sub>EN(SET)(H-MIN)</sub>                                | EN/SET Minimum High Time                     |   |     | 50  |      | ns    |
| t <sub>EN(SET)(H-MAX)</sub>                                | EN/SET Maximum High Time                     |   |     |     | 75   | μs    |

1. The AAT3104 is guaranteed to meet performance specification over the -40°C to 85°C operating temperature range and are assured by design, characterization and correlation with statistical process controls.

## Typical Characteristics

$V_{IN} = 3.6V$ ,  $C_{IN} = C_{OUT} = C1 = 1\mu F$ ;  $T_A = 25^\circ C$ , unless otherwise noted.

**1X Mode Turn-On Waveform**  
( $V_{IN} = 4.2V$ ; Load = 120mA)

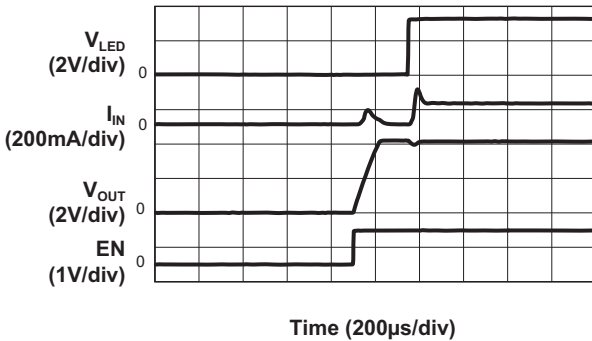

**2X Mode Turn-On Waveform**  
( $V_{IN} = 3.6V$ ; Load = 120mA)

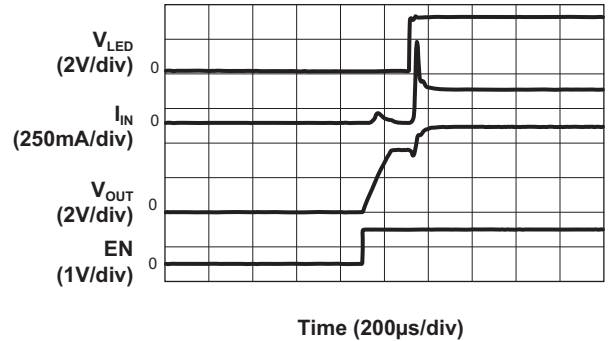

**2X Mode Turn-Off Waveform**  
( $V_{IN} = 3.6V$ ; Load = 120mA)

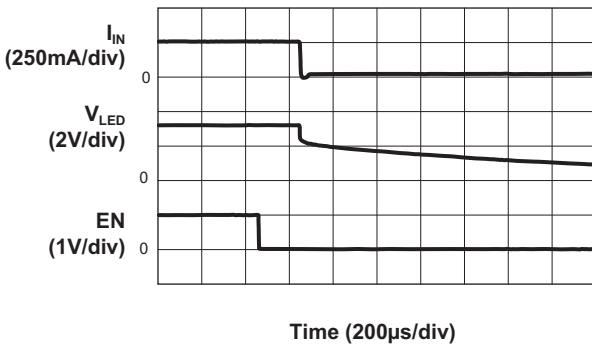

**2X Mode Output Ripple**  
( $V_{IN} = 3.6V$ ; Load = 120mA)

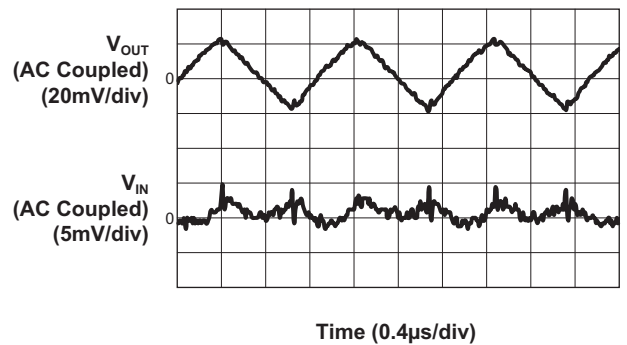

**1mA to 30mA LED Current Step**  
( $V_{IN} = 4.2V$ )

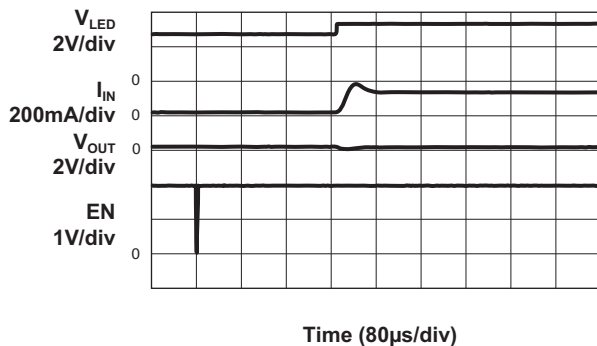

**30mA to 1mA LED Current Step**  
( $V_{IN} = 4.2V$ )

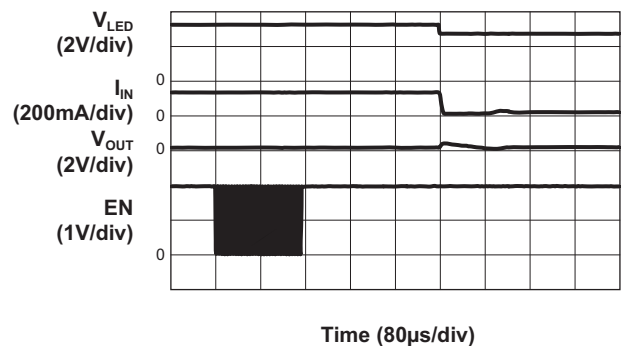

### Typical Characteristics

$V_{IN} = 3.6V$ ,  $C_{IN} = C_{OUT} = C1 = 1\mu F$ ;  $T_A = 25^\circ C$ , unless otherwise noted.

**Current Matching vs. Temperature**  
(AAT3104-2; Code = 1)

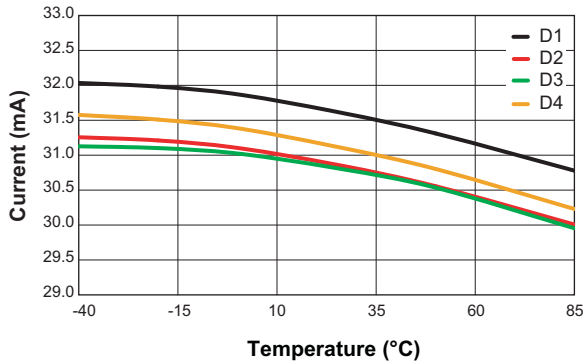

**Efficiency vs. Input Voltage**  
( $I_{LED} = 31mA \times 4$ ; Voltage Sweep Upwards)

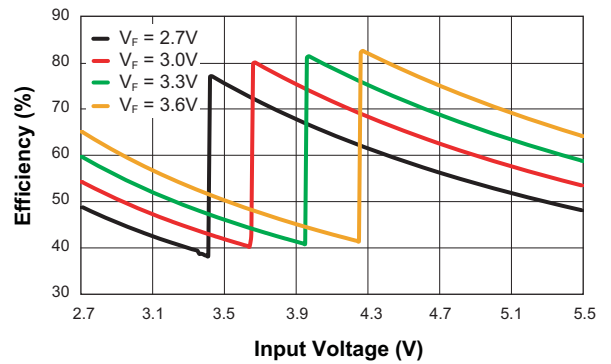

**Efficiency vs. Input Voltage**  
( $I_{LED} = 31mA \times 4$ ; Voltage Sweep Downwards)

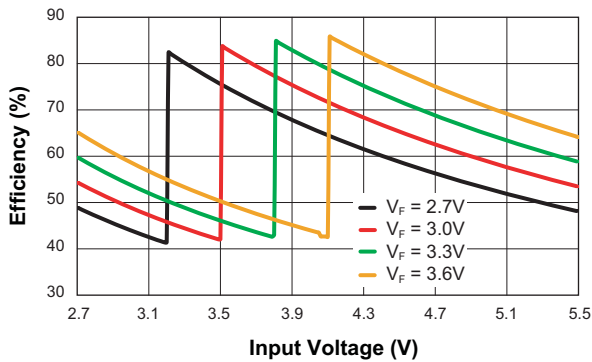

**Quiescent Current vs. Input Voltage**

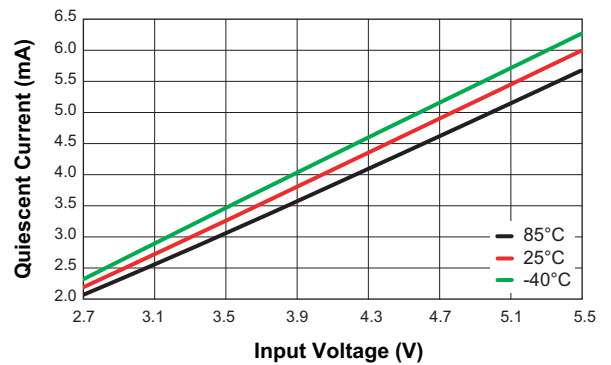

**Shutdown Current vs. Temperature**

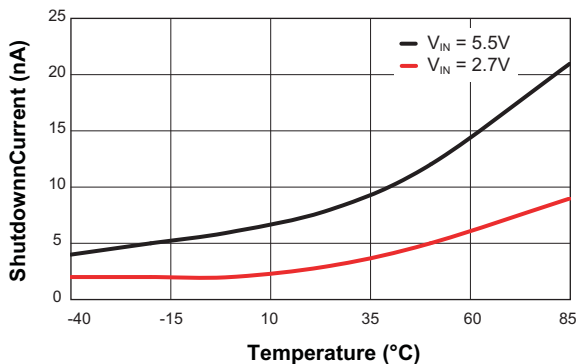

**Frequency vs. Temperature**

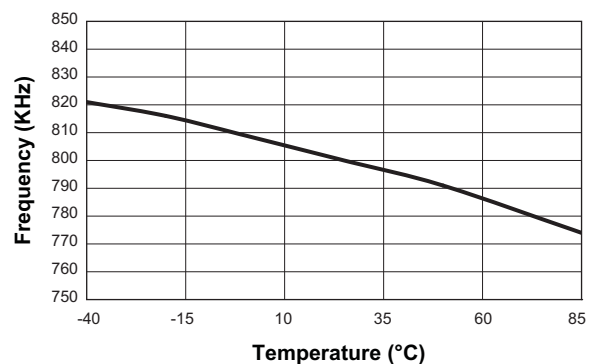

## Typical Characteristics

$V_{IN} = 3.6V$ ,  $C_{IN} = C_{OUT} = C1 = 1\mu F$ ;  $T_A = 25^\circ C$ , unless otherwise noted.

No Load Operating Current vs. Input Voltage  
(2x Mode)

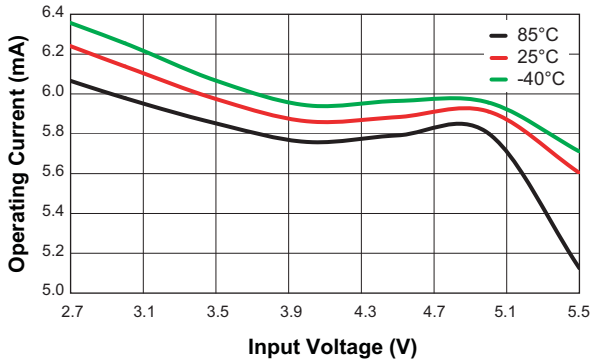

EN Input High Threshold Voltage vs. Input Voltage

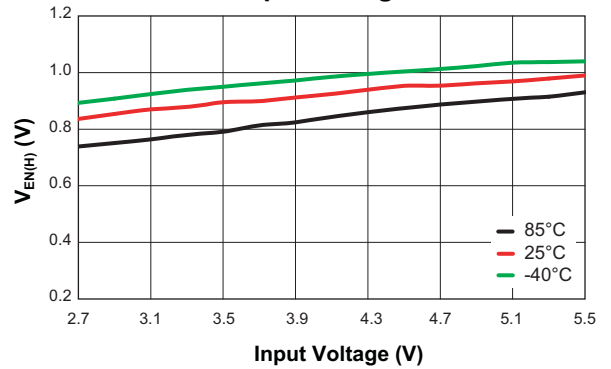

EN Input Low Threshold Voltage vs. Input Voltage

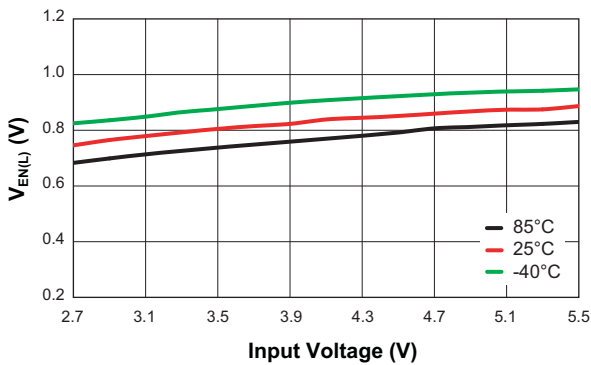

EN/SET Input Latch Timeout vs. Input Voltage

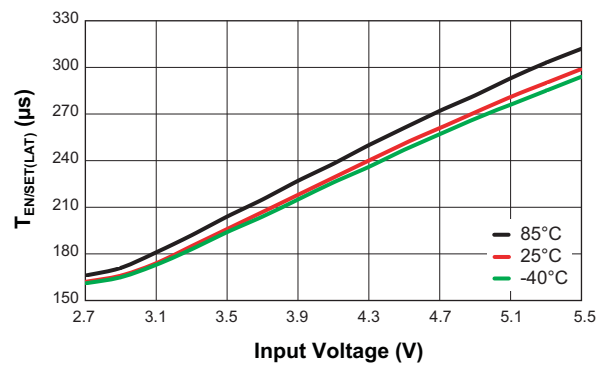

EN/SET Input OFF Timeout vs. Input Voltage

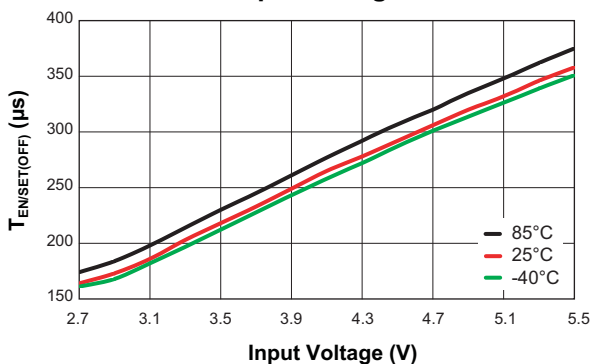

## Functional Block Diagram

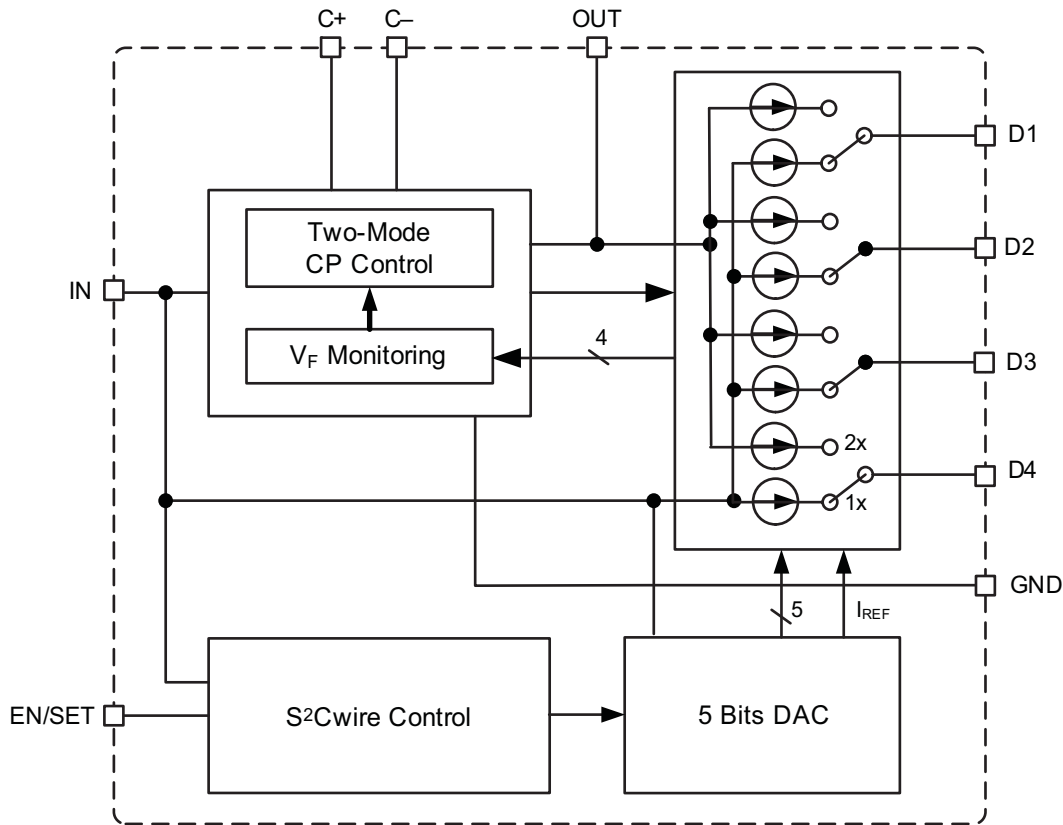

## Functional Description

The AAT3104 is a low-cost charge-pump solution designed to drive up to four white LEDs. The charge pump operates from a 2.7V to 5.5V power source and converts it to voltage levels necessary to drive the LEDs. LED current is individually controlled through integrated current sources powered from the output of the charge pump. Low 1x charge-pump output resistance and low-drop voltage current sources allow the charge pump to remain in 1x mode with an input voltage as low as 3.8V and LED forward voltages of 3.5V. Once in 2x mode, the charge pump monitors the input supply voltage and automatically switches back to 1x mode when there is sufficient input voltage.

The AAT3104 requires only three external components: one 1 $\mu$ F ceramic capacitor for the charge pump flying capacitor ( $C_P$ ), one 1 $\mu$ F ceramic input capacitor ( $C_{IN}$ ), one

1 $\mu$ F ceramic output capacitor ( $C_{OUT}$ ). The four constant current outputs of the AAT3104 (D1 to D4) can drive four individual LEDs with a maximum current of 30mA each. AnalogicTech's S<sup>2</sup>Cwire serial interface enables the AAT3104-1/-2 and changes the current source magnitudes through the EN/SET pin.

### S<sup>2</sup>Cwire Serial Interface

The LED output current of the AAT3104 is controlled by AnalogicTech's S<sup>2</sup>Cwire serial interface. Since the LED current is programmable, no PWM or additional control circuitry is needed to control LED brightness. This feature greatly reduces the burden on a microcontroller or system IC to manage LED or display brightness, allowing the user to "set it and forget it." With its high-speed serial interface (1MHz data rate), the LED current can be changed quickly and easily. Also, the non-pulsating LED



current reduces system noise and improves LED reliability. The S<sup>2</sup>Cwire interface relies on the number of rising edges to the EN/SET pin to set the register. A typical write protocol is a burst of EN/SET rising edges, followed by a pause with EN/SET held high for at least  $t_{LAT}$  (500 $\mu$ s). The programmed current is then seen at the current source outputs. When EN/SET is held low for an amount of time longer than  $t_{OFF}$  (500 $\mu$ s), the AAT3104 enters into shutdown mode and draws less than 1 $\mu$ A from the input and the internal data register is reset to zero.

The AAT3104-1/2's serial interface reduces the LED current on each rising pulse of the enable input. If the AAT3104 is in shutdown, the first rising edge of the EN/SET input turns on the LED driver to the maximum current. Successive rising edges decrease the LED current as shown in Table 1 and Figure 2 for the AAT3104-1. For the AAT3104-2, Table 2 and Figure 3 illustrate a 32-step LED current control profile.

| Data | EN Rising Edges | D1-D4 Current (mA) |
|------|-----------------|--------------------|
| 1    | 1               | 30                 |
| 2    | 2               | 28                 |
| 3    | 3               | 26                 |
| 4    | 4               | 24                 |
| 5    | 5               | 22                 |
| 6    | 6               | 20                 |
| 7    | 7               | 18                 |
| 8    | 8               | 16                 |
| 9    | 9               | 14                 |
| 10   | 10              | 12                 |
| 11   | 11              | 10                 |
| 12   | 12              | 8                  |
| 13   | 13              | 6                  |
| 14   | 14              | 4                  |
| 15   | 15              | 2                  |
| 16   | 16              | 0.5                |

Table 1: AAT3104-1 LED Current Settings.

| Data | EN Rising Edges | D1-D4 Current (mA) |
|------|-----------------|--------------------|
| 1    | 1               | 31                 |
| 2    | 2               | 30                 |
| 3    | 3               | 29                 |
| 4    | 4               | 28                 |
| 5    | 5               | 27                 |
| 6    | 6               | 26                 |
| 7    | 7               | 25                 |
| 8    | 8               | 24                 |
| 9    | 9               | 23                 |
| 10   | 10              | 22                 |
| 11   | 11              | 21                 |
| 12   | 12              | 20                 |
| 13   | 13              | 19                 |
| 14   | 14              | 18                 |
| 15   | 15              | 17                 |
| 16   | 16              | 16                 |
| 17   | 17              | 15                 |
| 18   | 18              | 14                 |
| 19   | 19              | 13                 |
| 20   | 20              | 12                 |
| 21   | 21              | 11                 |
| 22   | 22              | 10                 |
| 23   | 23              | 9                  |
| 24   | 24              | 8                  |
| 25   | 25              | 7                  |
| 26   | 26              | 6                  |
| 27   | 27              | 5                  |
| 28   | 28              | 4                  |
| 29   | 29              | 3                  |
| 30   | 30              | 2                  |
| 31   | 31              | 1                  |
| 32   | 32              | 0.5                |

Table 2: AAT3104-2 LED Current Settings.

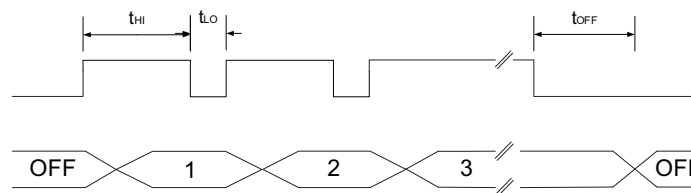

Figure 1: EN/SET Timing Diagram.

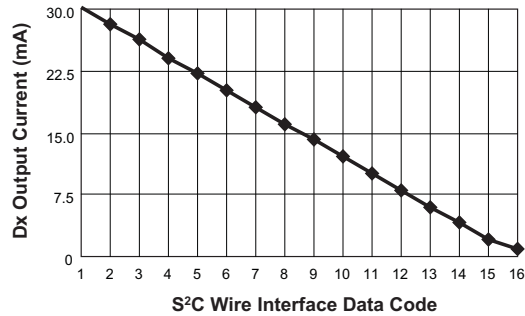

Figure 2: AAT3104-1 Current Control Profile.

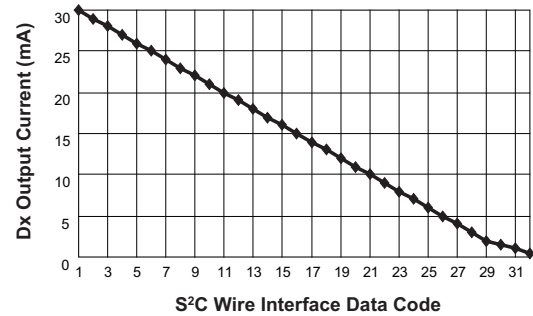

Figure 3: AAT3104-2 Current Control Profile.

## Applications Information

### LED Selection

The AAT3104 is specifically designed for driving white LEDs. However, the device design will allow the AAT3104 to drive most types of LEDs with forward voltage specifications ranging from 2.2V to 4.7V. LED applications may include mixed arrangements for display backlighting, keypad display, and any other application needing a constant current source generated from a varying input voltage. Since the D1 to D4 constant current sources are matched with negligible supply voltage dependence, the constant current channels will be matched regardless of the specific LED forward voltage ( $V_f$ ) levels.

The low dropout current sources in the AAT3104 maximize performance and make it capable of driving LEDs with high forward voltages. Multiple channels can be combined to obtain a higher LED drive current without complication.

All unused LED source pins should be connected to GND or left floating. Do not connect to the OUT pin.

### Device Switching Noise Performance

The AAT3104 operates at a fixed frequency of approximately 1MHz to control noise and limit harmonics that can interfere with the RF operation of mobile communication devices. Back-injected noise appearing on the input pin of the charge pump is 20mV peak-to-peak, typically ten times less than inductor-based DC/DC boost converter white LED backlight solutions. The AAT3104 soft-start feature prevents noise transient effects associated with inrush currents during start-up of the charge pump circuit.

### Shutdown

Since the current switches are the only power returns for all loads, there is no leakage current when all source switches are disabled. To enter shutdown operation, the EN/SET input for the AAT3104-1/2 should be strobed low. After  $t_{OFF}$  (500 $\mu$ s), AAT3104 will be shut down and typically draws less than 1 $\mu$ A from the input. Registers are reset to 0 in shutdown.

### Power Efficiency and Device Evaluation

The charge pump efficiency discussion in the following sections accounts only for efficiency of the charge pump section itself. Due to the unique circuit architecture and design of the AAT3104, it is very difficult to measure efficiency in terms of a percent value comparing input power over output power.

Since the AAT3104 outputs are pure constant current sources and typically drive individual loads, it is difficult to measure the output voltage for a given output to derive an overall output power measurement. For any given application, white LED forward voltage levels can differ, yet the output drive current will be maintained as a constant.

This makes quantifying output power a difficult task when taken in the context of comparing to other white LED driver circuit topologies. A better way to quantify total device efficiency is to observe the total input power to the device for a given LED current drive level. The best white LED driver for a given application should be based on trade-offs of size, external component count, reliability, operating range, and total energy usage, not just output power over input power efficiency.

The AAT3104 efficiency may be quantified under very specific conditions and is dependent upon the input voltage versus the output voltage across the loads applied

to outputs D1 through for a given constant current setting. Depending on the combination of  $V_{IN}$  and voltages sensed at the current sources, the device will operate in load switch mode. When any one of the voltages sensed at the current sources nears dropout, the device will operate in 2X charge pump mode.

Each of these modes will yield different efficiency values. Refer to the following two sections for explanations for each operational mode.

### 1X Mode Efficiency

The AAT3104 1X mode is operational at all times and functions alone to enhance device power conversion efficiency when  $V_{IN}$  is higher than the voltage across the load. When in 1X mode, voltage conversion efficiency is defined as output power divided by input power.

An expression for the ideal efficiency ( $\eta$ ) in 1X charge-pump mode can be expressed as:

$$\eta = \frac{P_{OUT}}{P_{IN}} = \frac{V_F \cdot I_{LED}}{V_{IN} \cdot I_{IN}} = \frac{V_F \cdot I_{LED}}{V_{IN} \cdot I_{OUT}} \approx \frac{V_F}{V_{IN}}$$

-or-

$$\eta (\%) = \frac{V_F}{V_{IN}} \cdot 100$$

For a charge pump led driver with  $V_F$  of 3.2V and 4.2V input voltage, the theoretical efficiency is 76%. Due to internal switching losses and IC quiescent current consumption, the actual efficiency can be measured at 73%.

### 2X Charge Pump Mode Efficiency

The AAT3104 contains a charge pump which will boost the input supply voltage in the event where  $V_{IN}$  is less than the voltage required to supply the output. The efficiency ( $\eta$ ) can be simply defined as a linear voltage regulator with an effective output voltage that is equal to one and two times the input voltage. Efficiency ( $\eta$ ) for an ideal 2X charge pump can typically be expressed as the output power divided by the input power.

$$\eta = \frac{P_F}{P_{IN}}$$

In addition, with an ideal 2X charge pump, the output current may be expressed as 1/3 of the input current. The expression to define the ideal efficiency ( $\eta$ ) can be rewritten as

$$\eta = \frac{P_{OUT}}{P_{IN}} = \frac{V_F \cdot I_{LED}}{V_{IN} \cdot I_{IN}} = \frac{V_F \cdot I_{LED}}{V_{IN} \cdot 2 \cdot I_{OUT}} \approx \frac{V_F}{2 \cdot V_{IN}}$$

-or-

$$\eta (\%) = \frac{V_F}{2 \cdot V_{IN}} \cdot 100$$

For a charge pump current source driver with  $V_F$  of 3.2V and 2.7V input voltage, the theoretical efficiency is 59%. Due to internal switching losses and IC quiescent current consumption, the actual efficiency can be measured at 57%. Efficiency will decrease substantially as load current drops below 1mA or when the voltage level at  $V_{IN}$  approaches the voltage level at  $V_{OUT}$ .

### Additional Applications

The current sources of the AAT3104 can be combined freely to drive higher current levels through one LED. As an example, a single LED can be driven at 120mA by combining together D1 through D4 outputs.

For lower-cost applications, the flying capacitor can be removed; C+ and C- should be floating. This will force AAT3104 to operate in 1X mode. To maintain regulated LED current, the input supply voltage has to be higher than the charge-pump's dropout voltage in 1X mode plus the forward voltage of the LED at the preset LED current.

### Capacitor Selection

Careful selection of the three external capacitors  $C_{IN}$ ,  $C_P$ , and  $C_{OUT}$  is important because they will affect turn-on time, output ripple, and transient performance. Optimum performance will be obtained when low equivalent series resistance (ESR) ceramic capacitors are used, in general, low ESR may be defined as less than 100mΩ. A value of 1μF for all four capacitors is a good starting point when choosing capacitors. If the constant current sources are only programmed for light current levels, then the capacitor size may be decreased.

### Capacitor Characteristics

Ceramic composition capacitors are highly recommended over all other types of capacitors for use with the AAT3104. Ceramic capacitors offer many advantages over their tantalum and aluminum electrolytic counterparts. A ceramic capacitor typically has very low ESR, is lowest cost, has a smaller PCB footprint, and is non-polarized. Low ESR ceramic capacitors help maximizing charge pump transient response. Since ceramic capacitors are non-polarized, they are not prone to incorrect connection damage.

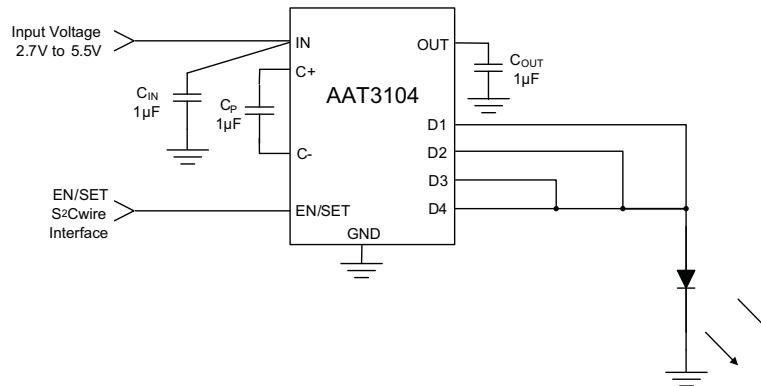
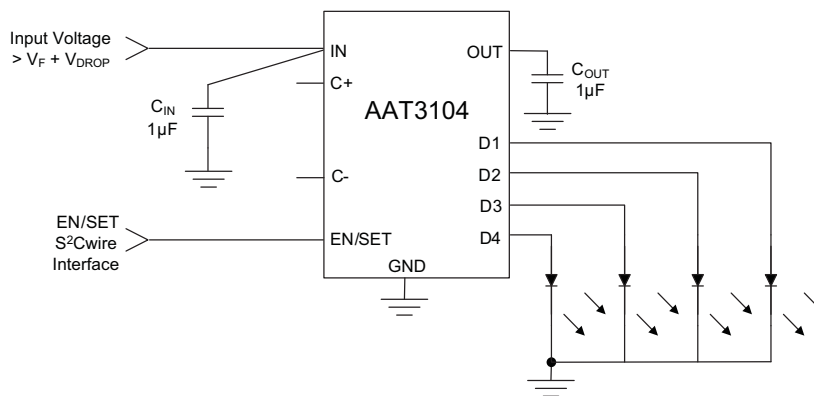
**Figure 4: Higher Current, Single LED Application.**

**Figure 5: Lower Cost 1X Mode Application.**

### Equivalent Series Resistance

ESR is an important characteristic to consider when selecting a capacitor. ESR is a resistance internal to a capacitor that is caused by the leads, internal connections, size or area, material composition, and ambient temperature. Capacitor ESR is typically measured in milliohms for ceramic capacitors and can range to more than several ohms for tantalum or aluminum electrolytic capacitors.

### Ceramic Capacitor Materials

Ceramic capacitors less than  $0.1\mu\text{F}$  are typically made from NPO or C0G materials. NPO and C0G materials generally have tight tolerance and are very stable over temperature. Larger capacitor values are usually composed of X7R, X5R, Z5U, or Y5V dielectric materials. Large ceramic capacitors (i.e., larger than  $2.2\mu\text{F}$ ) are often available in low cost Y5V and Z5U dielectrics, but capac-

itors larger than  $1\mu\text{F}$  are not typically required for AAT3104 applications. Capacitor area is another contributor to ESR. Capacitors that are physically large will have a lower ESR when compared to an equivalent material smaller capacitor. These larger devices can improve circuit transient response when compared to an equal value capacitor in a smaller package size.

### Evaluation Board Layout

When designing a PCB for the AAT3104, the key requirements are:

1. Place two flying capacitors C1 and C2 as close to the chip as possible; otherwise 2x mode performance will be compromised.
2. Place input and output decoupling capacitors as close to the chip as possible to reduce switching noise and output ripple.



## Ordering Information

| Package   | Interface            | Current Control, Inverting | Marking <sup>1</sup> | Part Number (Tape and Reel) <sup>2</sup> |
|-----------|----------------------|----------------------------|----------------------|--|
| SC70JW-10 | S <sup>2</sup> Cwire | 16-step                    |                      | AAT3104IJQ-1-T1                          |
| SC70JW-10 | S <sup>2</sup> Cwire | 32-step                    | 4DXY                 | <b>AAT3104IJQ-2-T1</b>                   |



All AnalogicTech products are offered in Pb-free packaging. The term "Pb-free" means semiconductor products that are in compliance with current RoHS standards, including the requirement that lead not exceed 0.1% by weight in homogeneous materials. For more information, please visit our website at <http://www.analogictech.com/about/quality.aspx>.

## Package Information

### SC70JW-10

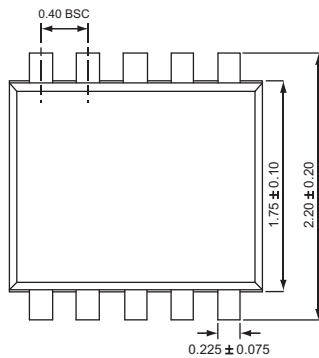

Top View

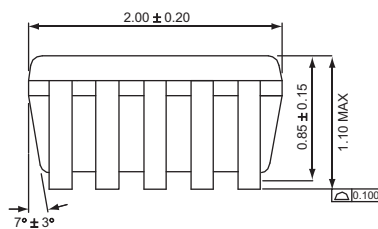

Side View

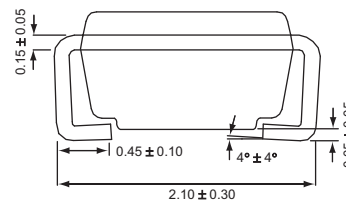

End View

All dimensions in millimeters.

1. XYY = assembly and date code.  
2. Sample stock is generally held on part numbers listed in **BOLD**.

**ChargePump™****Low Cost 1x/2x 4 Channel Charge Pump WLED Driver**

**Advanced Analogic Technologies, Inc.**  
3230 Scott Boulevard, Santa Clara, CA 95054  
Phone (408) 737-4600  
Fax (408) 737-4611



© Advanced Analogic Technologies, Inc.  
AnalogicTech cannot assume responsibility for use of any circuitry other than circuitry entirely embodied in an AnalogicTech product. No circuit patent licenses, copyrights, mask work rights, or other intellectual property rights are implied. AnalogicTech reserves the right to make changes to their products or specifications or to discontinue any product or service without notice. Except as provided in AnalogicTech's terms and conditions of sale, AnalogicTech assumes no liability whatsoever, and AnalogicTech disclaims any express or implied warranty relating to the sale and/or use of AnalogicTech products including liability or warranties relating to fitness for a particular purpose, merchantability, or infringement of any patent, copyright or other intellectual property right. In order to minimize risks associated with the customer's applications, adequate design and operating safeguards must be provided by the customer to minimize inherent or procedural hazards. Testing and other quality control techniques are utilized to the extent AnalogicTech deems necessary to support this warranty. Specific testing of all parameters of each device is not necessarily performed. AnalogicTech and the AnalogicTech logo are trademarks of Advanced Analogic Technologies Incorporated. All other brand and product names appearing in this document are registered trademarks or trademarks of their respective holders.