

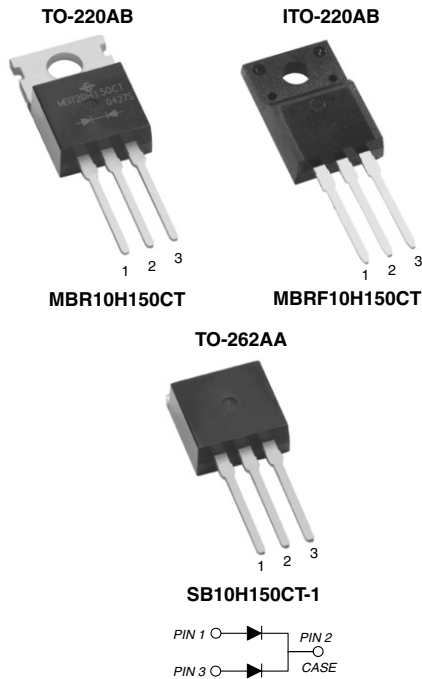

Dual Common-Cathode High-Voltage Schottky Rectifier

Low Leakage Current 5.0 μ A



FEATURES

- Guardring for overvoltage protection
- Low power loss, high efficiency
- Low forward voltage drop
- High frequency operation
- Solder dip 260 °C, 40 seconds
- Component in accordance to RoHS 2002/95/EC and WEEE 2002/96/EC

TYPICAL APPLICATIONS

For use in high frequency inverters, free-wheeling and polarity protection applications.

MECHANICAL DATA

Case: TO-220AB, ITO-220AB, TO-262AA

Epoxy meets UL 94V-0 flammability rating

Terminals: Matte tin plated leads, solderable per J-STD-002B and JESD22-B102D

E3 suffix for commercial grade

Mounting Torque: 10 in-lbs maximum

Polarity: As marked

PRIMARY CHARACTERISTICS

$I_{F(AV)}$	2 x 5 A
V_{RRM}	150 V
I_{FSM}	160 A
V_F	0.72 V
T_j	175 °C

MAXIMUM RATINGS ($T_C = 25$ °C unless otherwise noted)

PARAMETER	SYMBOL	MBR10H150CT	UNIT
Maximum repetitive peak reverse voltage	V_{RRM}	150	V
Working peak reverse voltage	V_{RWM}	150	V
Maximum DC blocking voltage	V_{DC}	150	V
Maximum average forward rectified current (see Fig. 1)	$I_{F(AV)}$	10	A
Total device per diode		5	
Peak forward surge current 8.3 ms single half sine-wave superimposed on rated load per diode	I_{FSM}	160	A
Peak repetitive reverse current per diode at $t_p = 2$ μ s, 1 kHz	I_{RRM}	1.0	A
Peak non-repetitive reverse surge energy per diode (8/20 μ s waveform)	E_{RSM}	10	mJ
Non-repetitive avalanche energy per diode at 25 °C, $I_{AS} = 1.5$ A, L = 10 mH	E_{AS}	11.25	mJ
Voltage rate of change (rated V_R)	dv/dt	10000	V/ μ s
Operating junction and storage temperature range	T_j, T_{STG}	- 65 to + 175	°C
Isolation voltage (ITO-220AB only) From terminals to heatsink t = 1 minute	V_{AC}	1500	V

ELECTRICAL CHARACTERISTICS ($T_C = 25\text{ }^\circ\text{C}$ unless otherwise noted)				
PARAMETER	TEST CONDITIONS	SYMBOL	VALUE	UNIT
Maximum instantaneous forward voltage per diode ⁽¹⁾	at $I_F = 5.0\text{ A}$, $T_J = 25\text{ }^\circ\text{C}$	V_F	0.88	V
	at $I_F = 5.0\text{ A}$, $T_J = 125\text{ }^\circ\text{C}$		0.72	
	at $I_F = 10\text{ A}$, $T_J = 25\text{ }^\circ\text{C}$		0.96	
	at $I_F = 10\text{ A}$, $T_J = 125\text{ }^\circ\text{C}$		0.80	
Maximum reverse current per diode at working peak reverse voltage ⁽¹⁾	$T_J = 25\text{ }^\circ\text{C}$	I_R	5.0	μA mA
	$T_J = 125\text{ }^\circ\text{C}$		1.0	

Note:

(1) Pulse test: 300 μs pulse width, 1 % duty cycle

THERMAL CHARACTERISTICS ($T_C = 25\text{ }^\circ\text{C}$ unless otherwise noted)					
PARAMETER	SYMBOL	MBR	MBRF	MBRB	UNIT
Typical thermal resistance per diode	$R_{\theta JC}$	2.4	4.5	2.4	$^\circ\text{C/W}$

ORDERING INFORMATION (Example)					
PACKAGE	PREFERRED P/N	UNIT WEIGHT (g)	PACKAGE CODE	BASE QUANTITY	DELIVERY MODE
TO-220AB	MBR10H150CT-E3/45	2.06	45	50/Tube	Tube
ITO-220AB	MBRF10H150CT-E3/45	2.20	45	50/Tube	Tube
TO-262AA	SB10H150CT-1E3/45	1.58	45	50/Tube	Tube

RATINGS AND CHARACTERISTICS CURVES

($T_A = 25\text{ }^\circ\text{C}$ unless otherwise noted)

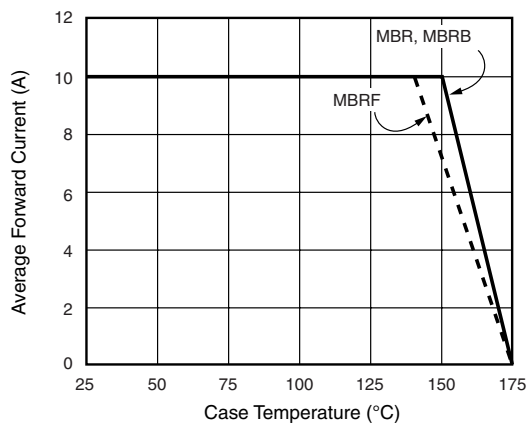

Figure 1. Forward Derating Curve (Total)

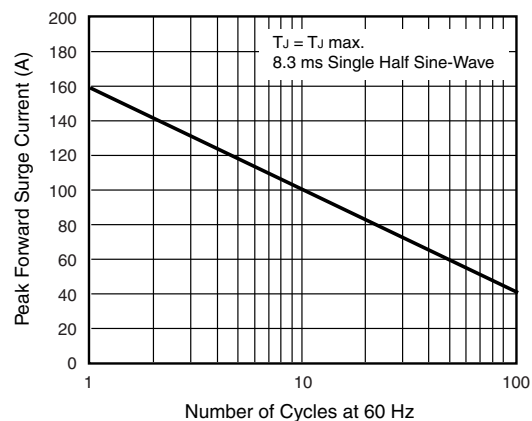

Figure 2. Maximum Non-Repetitive Peak Forward Surge Current Per Diode



MBR10H150CT, MBRF10H150CT & SB10H150CT-1

Vishay General Semiconductor

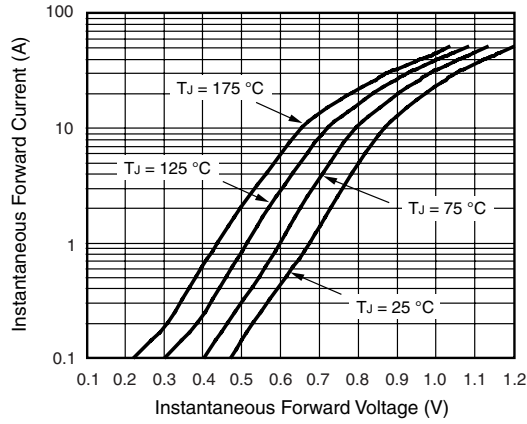

Figure 3. Typical Instantaneous Forward Characteristics Per Diode

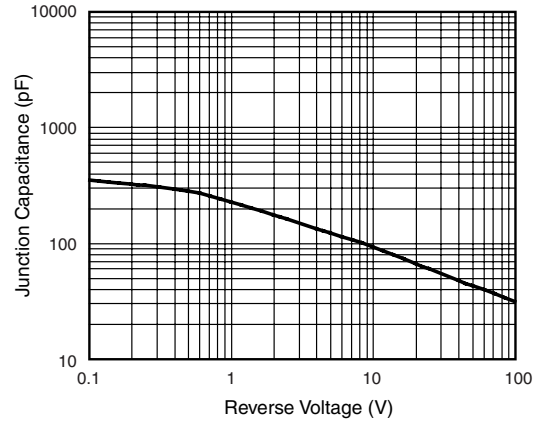

Figure 5. Typical Junction Capacitance Per Diode

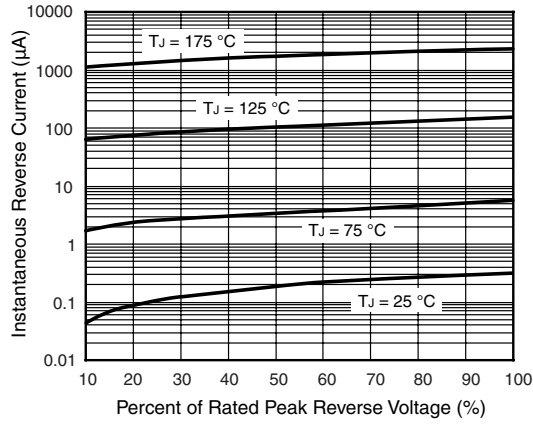

Figure 4. Typical Reverse Characteristics Per Diode

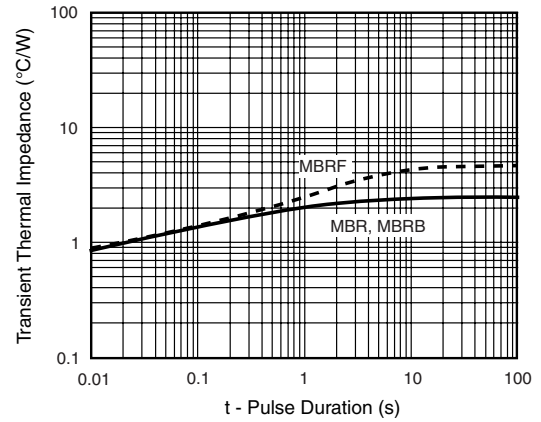
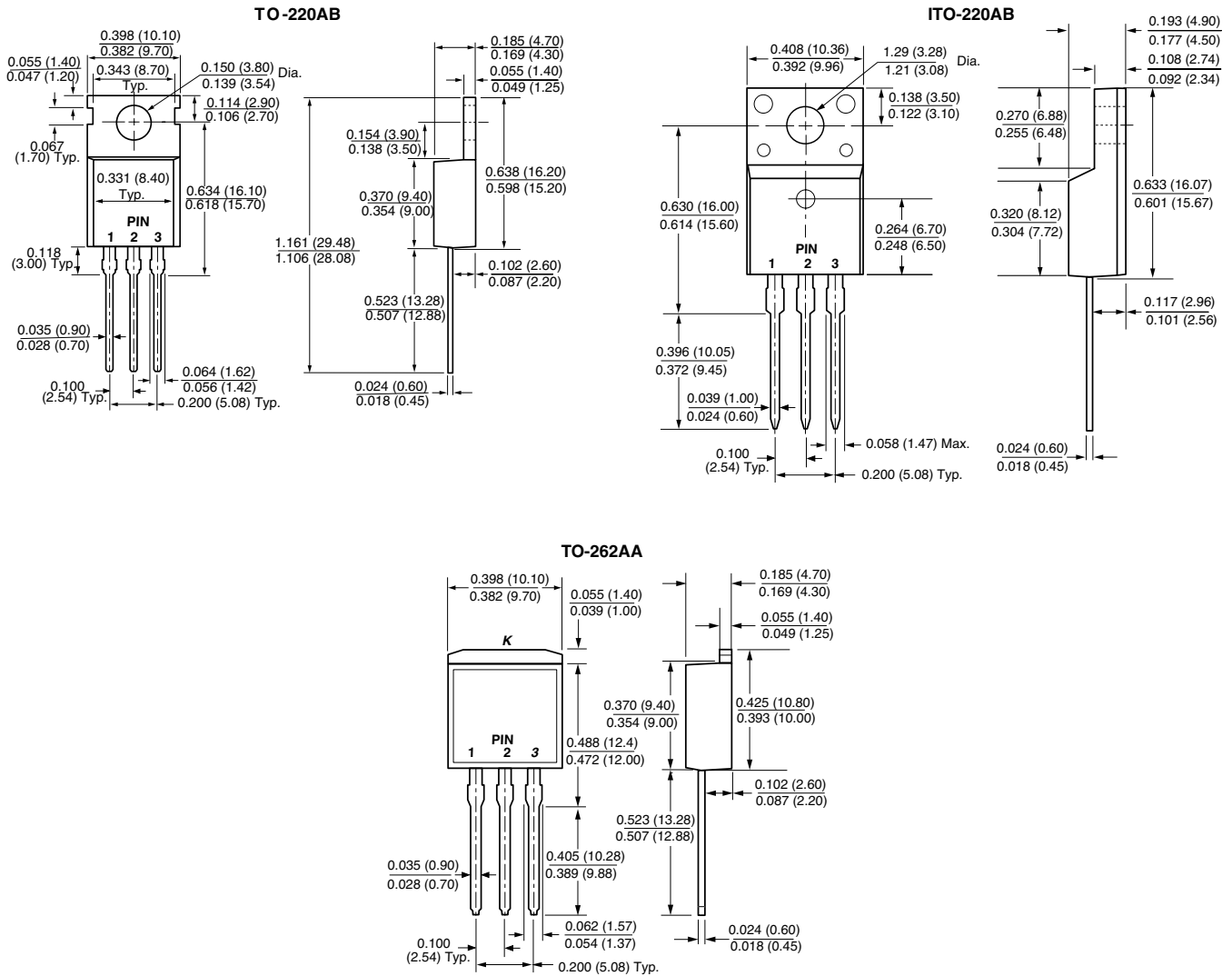

Figure 6. Typical Transient Thermal Impedance Per Diode

PACKAGE OUTLINE DIMENSIONS in inches (millimeters)





Notice

Specifications of the products displayed herein are subject to change without notice. Vishay Intertechnology, Inc., or anyone on its behalf, assumes no responsibility or liability for any errors or inaccuracies.

Information contained herein is intended to provide a product description only. No license, express or implied, by estoppel or otherwise, to any intellectual property rights is granted by this document. Except as provided in Vishay's terms and conditions of sale for such products, Vishay assumes no liability whatsoever, and disclaims any express or implied warranty, relating to sale and/or use of Vishay products including liability or warranties relating to fitness for a particular purpose, merchantability, or infringement of any patent, copyright, or other intellectual property right.

The products shown herein are not designed for use in medical, life-saving, or life-sustaining applications. Customers using or selling these products for use in such applications do so at their own risk and agree to fully indemnify Vishay for any damages resulting from such improper use or sale.