

N-Channel 1.8-V (G-S) MOSFET With Schottky Diode



Pb-free
Available

MOSFET PRODUCT SUMMARY		
V_{DS} (V)	$r_{DS(on)}$ (Ω)	I_D (A)
20	0.040 @ $V_{GS} = 4.5$ V	5.9
	0.045 @ $V_{GS} = 2.5$ V	5.6
	0.052 @ $V_{GS} = 1.8$ V	5.2

SCHOTTKY PRODUCT SUMMARY		
V_{KA} (V)	V_f (V) Diode Forward Voltage	I_F (A)
20	0.375 V @ 1.0	1.0

FEATURES

- TrenchFET® Power MOSFETS
- Ultra Low $r_{DS(on)}$
- Ultra Low V_f Schottky
- Si5853DC Pin Compatible

APPLICATIONS

- Buck Rectifier Switch, Buck-Boost
- Synchronous Rectifier or Load
- Switch For Portable Devices

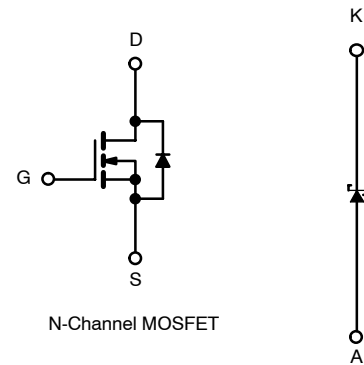
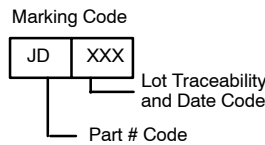
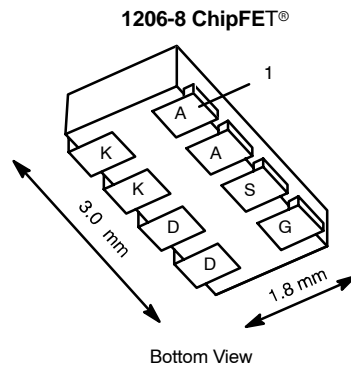

Ordering Information: Si5856DC-T1
Si5856DC-T1—E3 (Lead (Pb)-Free)

ABSOLUTE MAXIMUM RATINGS ($T_A = 25^\circ\text{C}$ UNLESS OTHERWISE NOTED)					
Parameter	Symbol	5 sec	Steady State	Unit	
Drain-Source Voltage (MOSFET and Schottky)	V_{DS}	20		V	
Reverse Voltage (Schottky)	V_{KA}	20			
Gate-Source Voltage (MOSFET)	V_{GS}	± 8			
Continuous Drain Current ($T_J = 150^\circ\text{C}$) (MOSFET) ^a	I_D	$T_A = 25^\circ\text{C}$	5.9	4.4	A
		$T_A = 85^\circ\text{C}$	4.2	3.1	
Pulsed Drain Current (MOSFET)	I_{DM}	20			
Continuous Source Current (MOSFET Diode Conduction) ^a	I_S	1.8	0.9		
Average Forward Current (Schottky)	I_F	1.0			
Pulsed Forward Current (Schottky)	I_{FM}	7			
Maximum Power Dissipation (MOSFET) ^a	P_D	$T_A = 25^\circ\text{C}$	2.1	1.1	
		$T_A = 85^\circ\text{C}$	1.1	0.6	
Maximum Power Dissipation (Schottky) ^a	P_D	$T_A = 25^\circ\text{C}$	1.9	1.1	
		$T_A = 85^\circ\text{C}$	1.0	0.56	
Operating Junction and Storage Temperature Range	T_J, T_{stg}	-55 to 150		$^\circ\text{C}$	
Soldering Recommendations (Peak Temperature) ^{b, c}		260			

Notes

- Surface Mounted on 1" x 1" FR4 Board.
- See Reliability Manual for profile. The ChipFET is a leadless package. The end of the lead terminal is exposed copper (not plated) as a result of the singulation process in manufacturing. A solder fillet at the exposed copper tip cannot be guaranteed and is not required to ensure adequate bottom side solder interconnection.
- Rework Conditions: manual soldering with a soldering iron is not recommended for leadless components.



THERMAL RESISTANCE RATINGS						
Parameter		Device	Symbol	Typical	Maximum	Unit
Junction-to-Ambient ^a	$t \leq 5 \text{ sec}$	MOSFET	R_{thJA}	50	60	°C/W
		Schottky		54	65	
	Steady State	MOSFET		90	110	
		Schottky		95	115	
Junction-to-Foot	Steady State	MOSFET	R_{thJF}	30	40	
		Schottky		30	40	

Notes

a. Surface Mounted on 1" x 1" FR4 Board.

MOSFET SPECIFICATIONS ($T_J = 25^\circ\text{C}$ UNLESS OTHERWISE NOTED)						
Parameter	Symbol	Test Condition	Min	Typ	Max	Unit
Static						
Gate Threshold Voltage	$V_{GS(th)}$	$V_{DS} = V_{GS}, I_D = 250 \mu\text{A}$	0.4		1.0	V
Gate-Body Leakage	I_{GSS}	$V_{DS} = 0 \text{ V}, V_{GS} = \pm 8 \text{ V}$			± 100	nA
Zero Gate Voltage Drain Current	I_{DSS}	$V_{DS} = 20 \text{ V}, V_{GS} = 0 \text{ V}$			1	μA
		$V_{DS} = 20 \text{ V}, V_{GS} = 0 \text{ V}, T_J = 85^\circ\text{C}$			5	
On-State Drain Current ^a	$I_{D(on)}$	$V_{DS} \geq 5 \text{ V}, V_{GS} = 4.5 \text{ V}$	20			A
Drain-Source On-State Resistance ^a	$r_{DS(on)}$	$V_{GS} = 4.5 \text{ V}, I_D = 4.4 \text{ A}$		0.032	0.040	Ω
		$V_{GS} = 2.5 \text{ V}, I_D = 4.1 \text{ A}$		0.036	0.045	
		$V_{GS} = 1.8 \text{ V}, I_D = 1.9 \text{ A}$		0.042	0.052	
Forward Transconductance ^a	g_{fs}	$V_{DS} = 10 \text{ V}, I_D = 4.4 \text{ A}$		22		S
Diode Forward Voltage ^a	V_{SD}	$I_S = 1.0 \text{ A}, V_{GS} = 0 \text{ V}$		0.8	1.2	V
Dynamic^b						
Total Gate Charge	Q_g	$V_{DS} = 10 \text{ V}, V_{GS} = 4.5 \text{ V}, I_D = 4.4 \text{ A}$		5	7.5	nC
Gate-Source Charge	Q_{gs}		0.85			
Gate-Drain Charge	Q_{gd}		1			
Turn-On Delay Time	$t_{d(on)}$	$V_{DD} = 10 \text{ V}, R_L = 10 \Omega$ $I_D \cong 1 \text{ A}, V_{GEN} = 4.5 \text{ V}, R_G = 6 \Omega$		20	30	ns
Rise Time	t_r			36	55	
Turn-Off Delay Time	$t_{d(off)}$			30	45	
Fall Time	t_f			12	20	
Source-Drain Reverse Recovery Time	t_{rr}	$I_F = 0.9 \text{ A}, di/dt = 100 \text{ A}/\mu\text{s}$		45	90	

Notes

- a. Pulse test; pulse width $\leq 300 \mu\text{s}$, duty cycle $\leq 2\%$,
b. Guaranteed by design, not subject to production testing.

Stresses beyond those listed under "Absolute Maximum Ratings" may cause permanent damage to the device. These are stress ratings only, and functional operation of the device at these or any other conditions beyond those indicated in the operational sections of the specifications is not implied. Exposure to absolute maximum rating conditions for extended periods may affect device reliability.

SCHOTTKY SPECIFICATIONS ($T_J = 25^\circ\text{C}$ UNLESS OTHERWISE NOTED)						
Parameter	Symbol	Test Condition	Min	Typ	Max	Unit
Forward Voltage Drop	V_F	$I_F = 1.0$		0.34	0.375	V
		$I_F = 1.0, T_J = 125^\circ\text{C}$		0.255	0.290	
Maximum Reverse Leakage Current	I_{rm}	$V_r = 20 \text{ V}$		0.05	0.500	mA
		$V_r = 20 \text{ V}, T_J = 85^\circ\text{C}$		2	20	
		$V_r = 20 \text{ V}, T_J = 125^\circ\text{C}$		10	100	
Junction Capacitance	C_T	$V_r = 10 \text{ V}$		90		pF



TYPICAL CHARACTERISTICS (25°C UNLESS NOTED) MOSFET

Output Characteristics

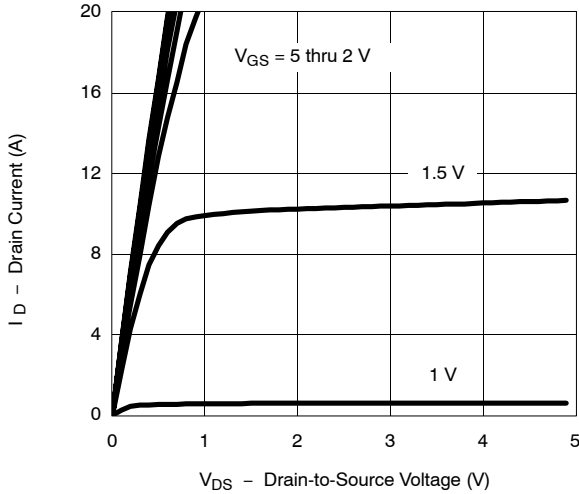

Transfer Characteristics

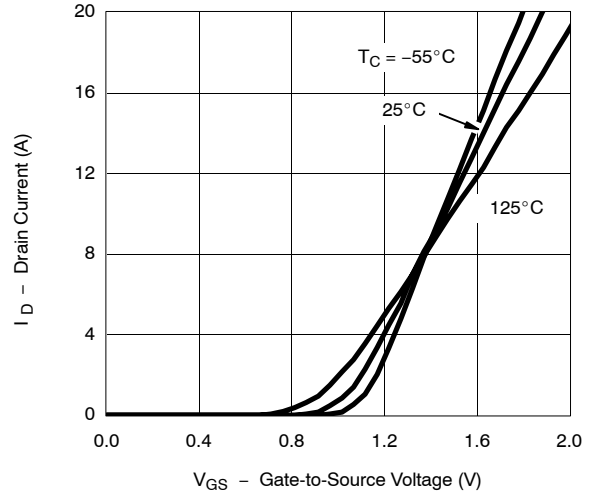

On-Resistance vs. Drain Current

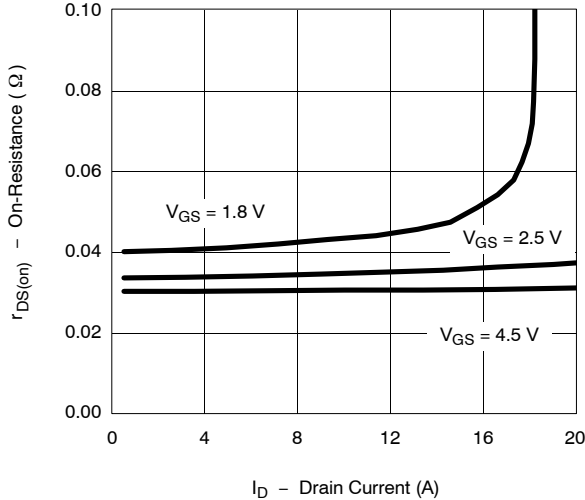

Capacitance

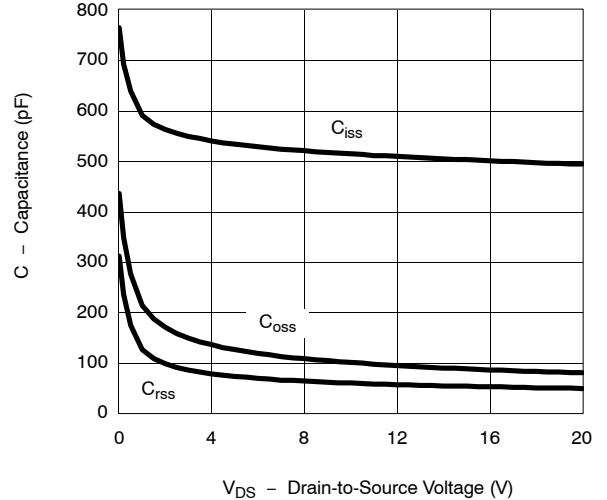

Gate Charge

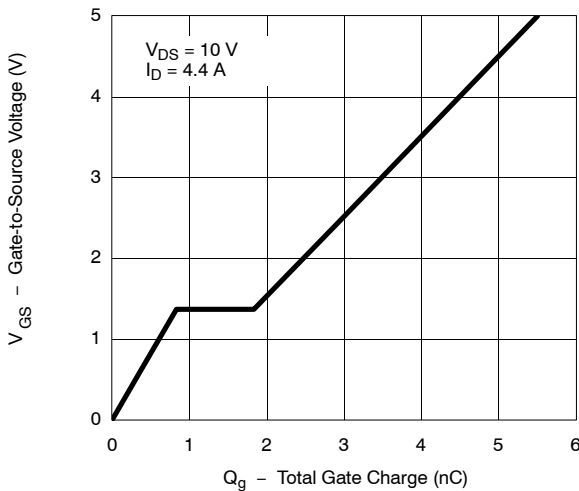

On-Resistance vs. Junction Temperature

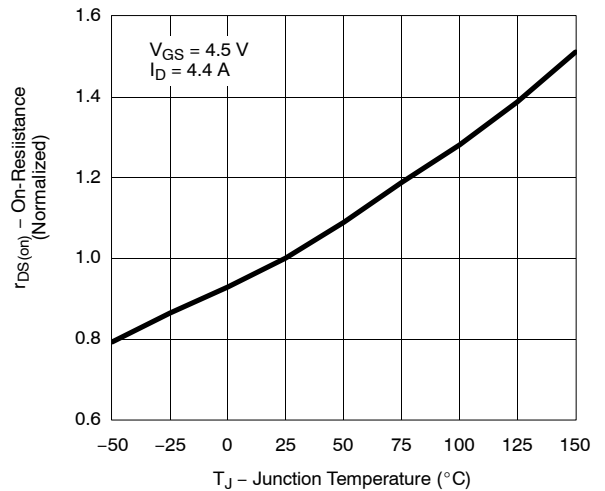

TYPICAL CHARACTERISTICS (25 °C UNLESS NOTED) MOSFET

Source-Drain Diode Forward Voltage

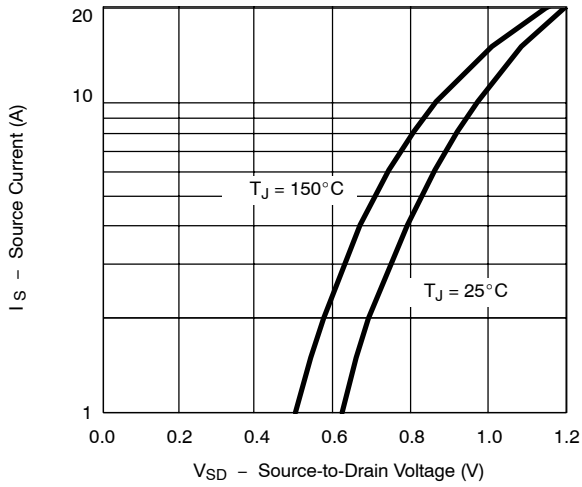

On-Resistance vs. Gate-to-Source Voltage

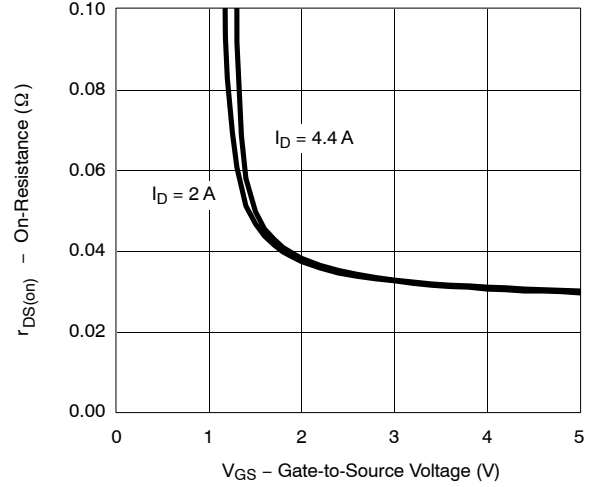

Threshold Voltage

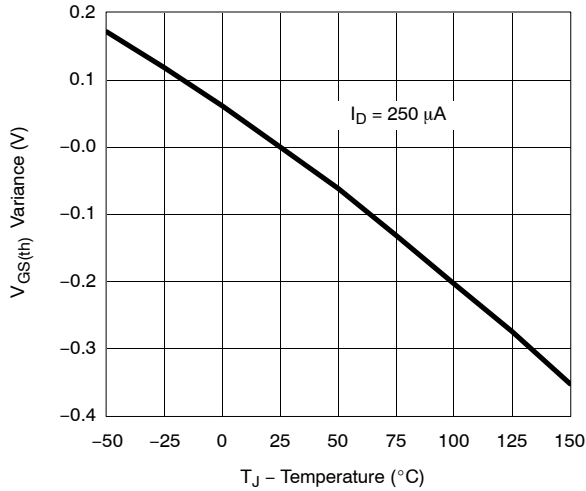

Single Pulse Power

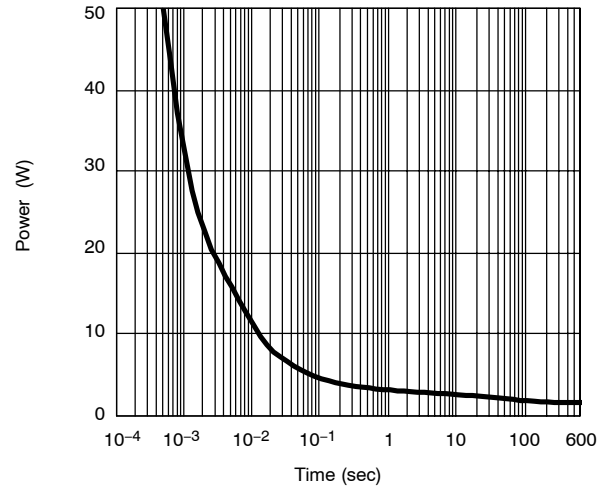

Safe Operating Area

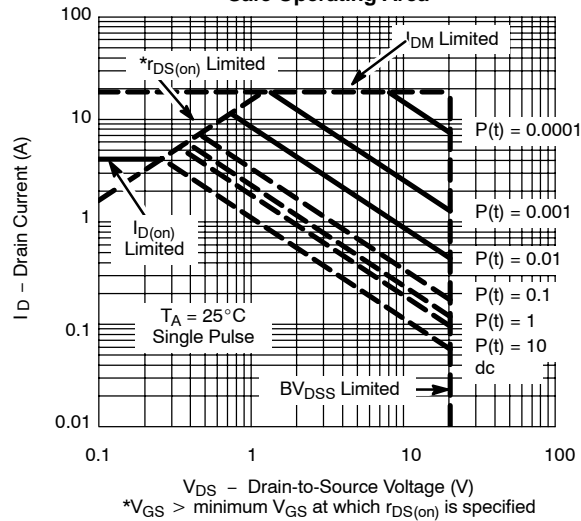

TYPICAL CHARACTERISTICS (25°C UNLESS NOTED) MOSFET

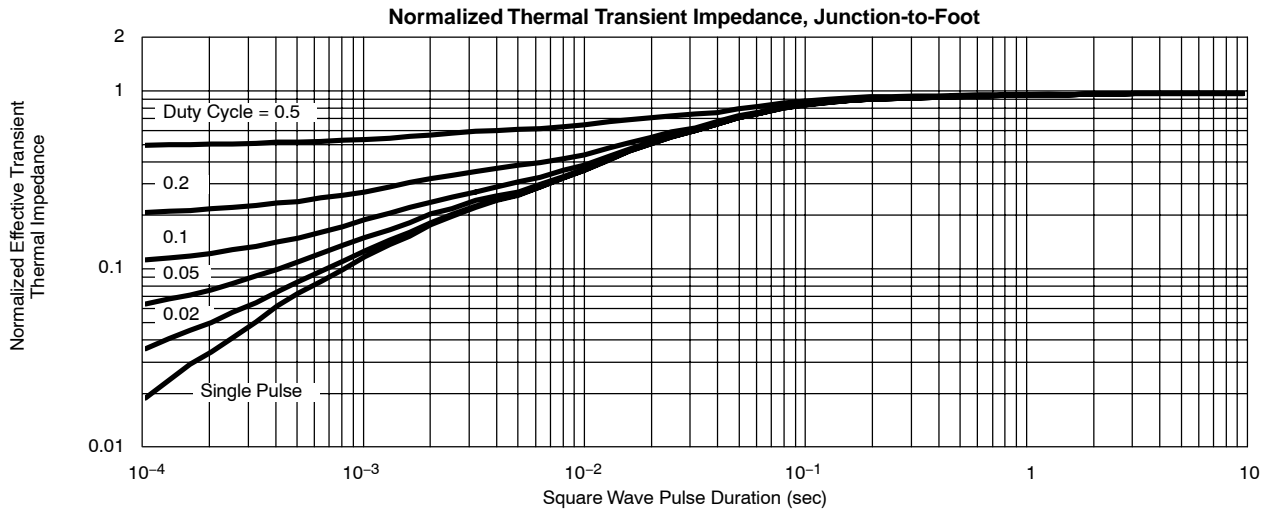
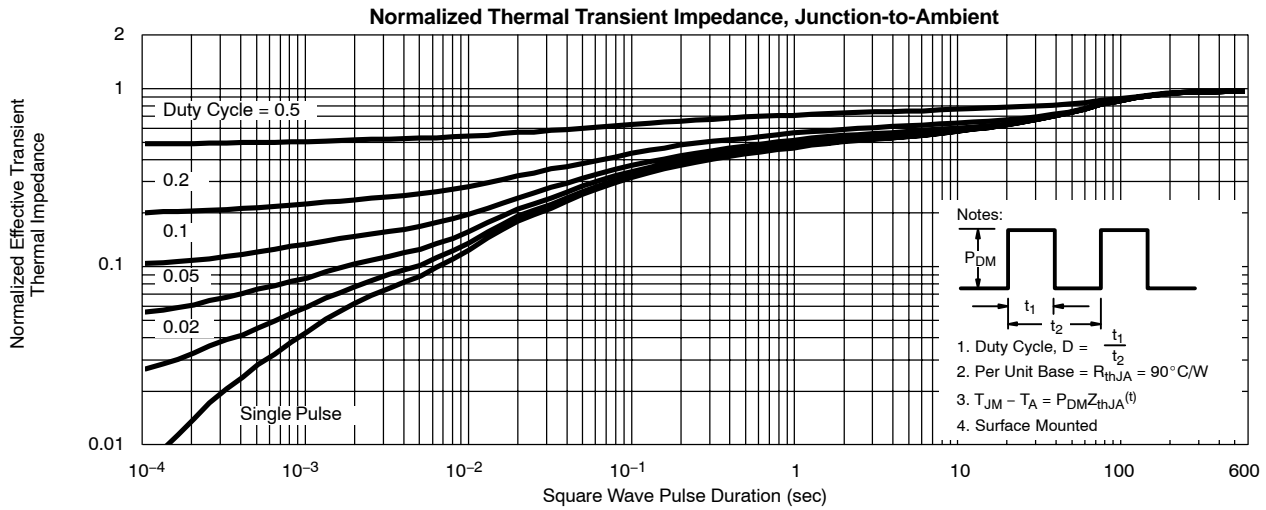

TYPICAL CHARACTERISTICS (25°C UNLESS NOTED) SCHOTTKY

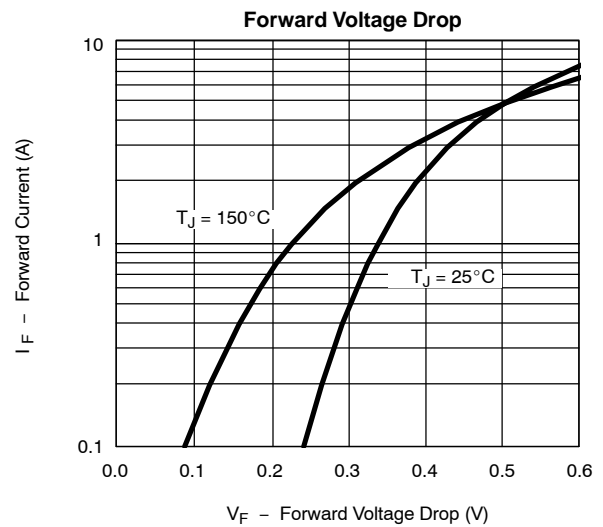
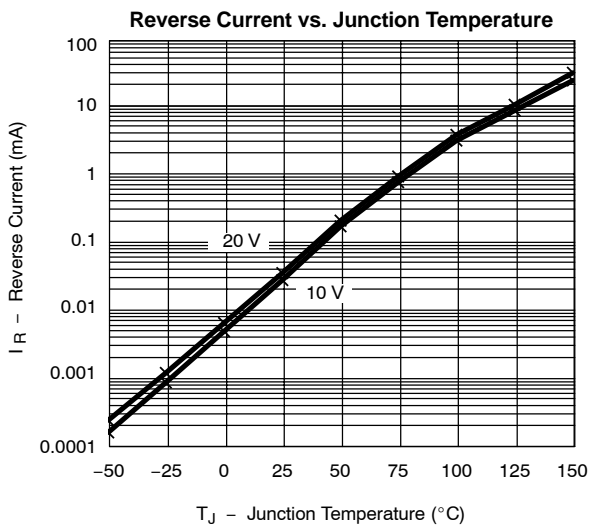

TYPICAL CHARACTERISTICS (25 °C UNLESS NOTED) SCHOTTKY

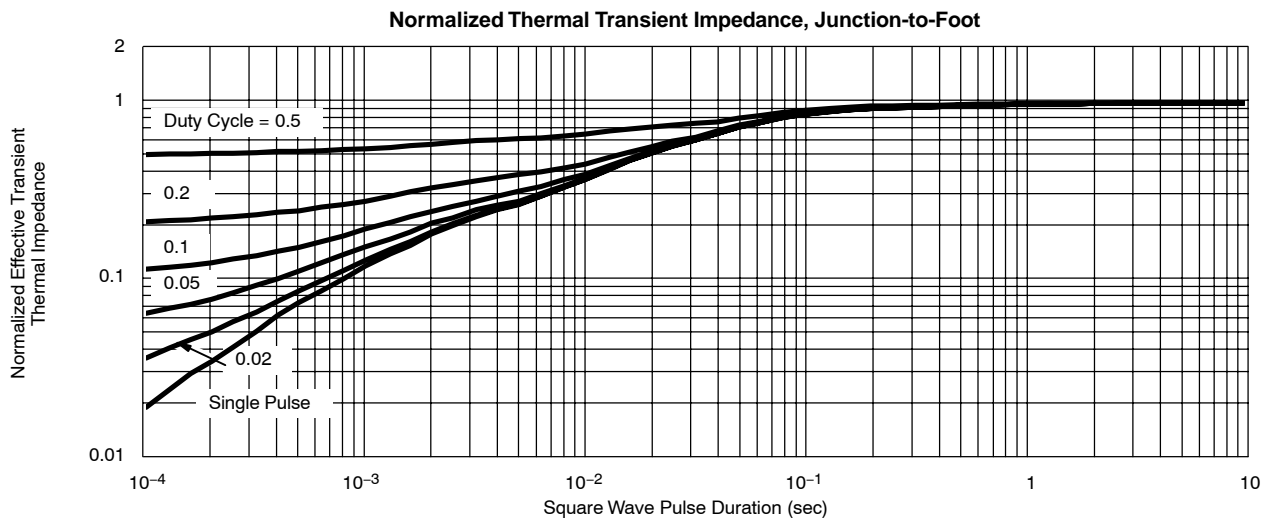
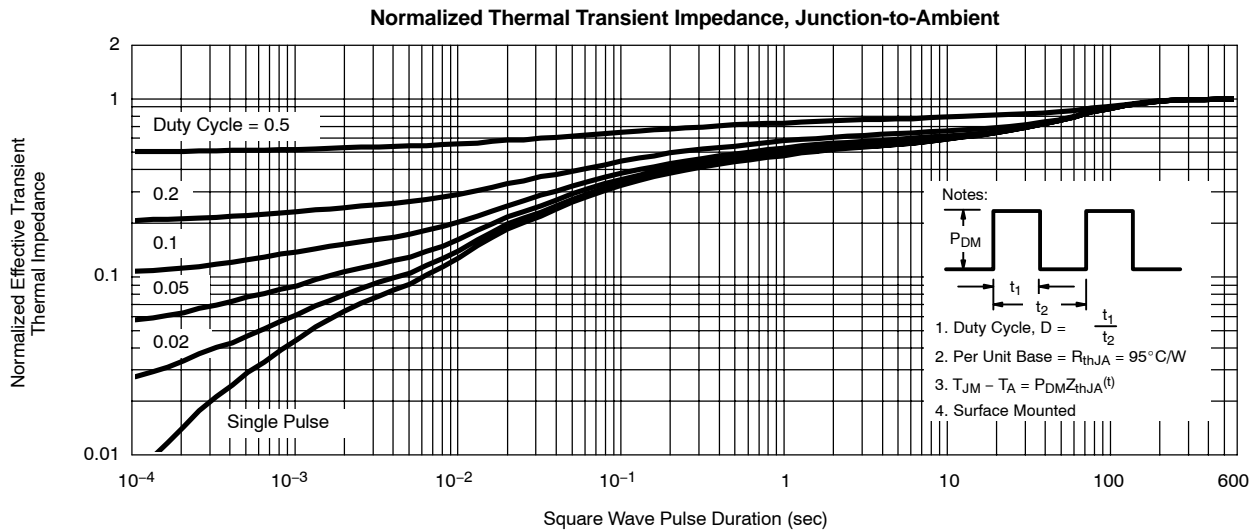
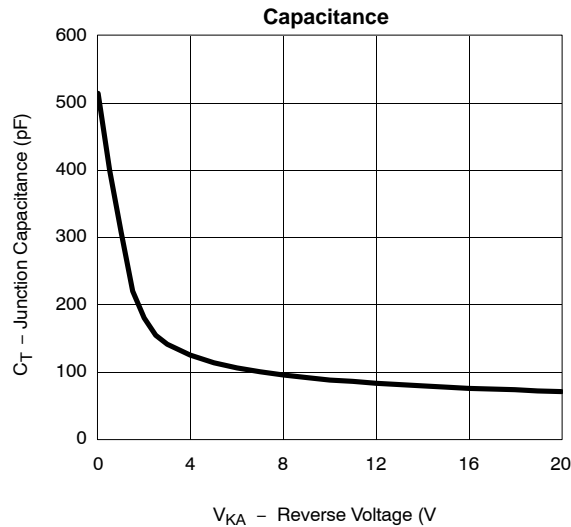

Vishay Siliconix maintains worldwide manufacturing capability. Products may be manufactured at one of several qualified locations. Reliability data for Silicon Technology and Package Reliability represent a composite of all qualified locations. For related documents such as package/tape drawings, part marking, and reliability data, see <http://www.vishay.com/ppg?72234>.



Disclaimer

All product specifications and data are subject to change without notice.

Vishay Intertechnology, Inc., its affiliates, agents, and employees, and all persons acting on its or their behalf (collectively, "Vishay"), disclaim any and all liability for any errors, inaccuracies or incompleteness contained herein or in any other disclosure relating to any product.

Vishay disclaims any and all liability arising out of the use or application of any product described herein or of any information provided herein to the maximum extent permitted by law. The product specifications do not expand or otherwise modify Vishay's terms and conditions of purchase, including but not limited to the warranty expressed therein, which apply to these products.

No license, express or implied, by estoppel or otherwise, to any intellectual property rights is granted by this document or by any conduct of Vishay.

The products shown herein are not designed for use in medical, life-saving, or life-sustaining applications unless otherwise expressly indicated. Customers using or selling Vishay products not expressly indicated for use in such applications do so entirely at their own risk and agree to fully indemnify Vishay for any damages arising or resulting from such use or sale. Please contact authorized Vishay personnel to obtain written terms and conditions regarding products designed for such applications.

Product names and markings noted herein may be trademarks of their respective owners.