

Low drop power Schottky rectifier in flat package

Main product characteristics

$I_{F(AV)}$	1 A
V_{RRM}	20 V
T_j (max)	150° C
V_F (max)	0.37 V

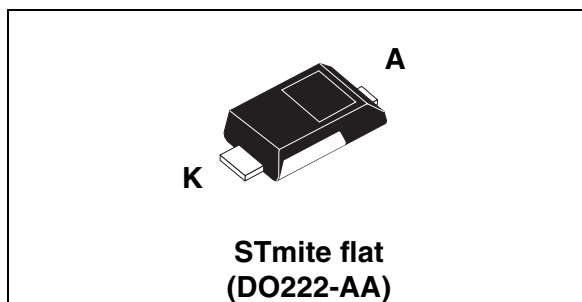

Features and benefits

- Very low profile package: 0.85 mm
- Backward compatible with standard STmite footprint
- Very small conduction losses
- Negligible switching losses
- Extremely fast switching
- Low forward voltage drop for higher efficiency and extended battery life
- Low thermal resistance
- Avalanche capability specified

Description

Single Schottky rectifier suited for switch mode power supplies and high frequency DC to DC converters.

Packaged in STmite flat, this device is intended for use in low voltage, high frequency inverters, free wheeling and polarity protection applications. Due to the very small size of the package this device fits battery powered equipment (cellular, notebook, PDA's, printers) as well as chargers and PCMCIA cards.

Order Code

Part number	Marking
STPS1L20MF	F1L2

Table 1. Absolute ratings (limiting values)

Symbol	Parameter	Value	Unit
V_{RRM}	Repetitive peak reverse voltage	20	V
$I_{F(RMS)}$	RMS forward current	2	A
$I_{F(AV)}$	Average forward current	$T_c = 140^\circ\text{C} \quad \delta = 0.5$ 1	A
I_{FSM}	Surge non repetitive forward current	$t_p = 10 \text{ ms sinusoidal}$ 50	A
P_{ARM}	Repetitive peak avalanche power	$t_p = 1 \mu\text{s} \quad T_j = 25^\circ\text{C}$ 1400	W
T_{stg}	Storage temperature range	-65 to + 150	°C
T_j	Maximum operating junction temperature ⁽¹⁾	150	°C
dV/dt	Critical rate of rise of reverse voltage (rated V_R , $T_j = 25^\circ\text{C}$)	10000	V/ μs

1. $\frac{dP_{tot}}{dT_j} < \frac{1}{R_{th(j-a)}}$ condition to avoid thermal runaway for a diode on its own heatsink

1 Characteristics

Table 2. Thermal resistance

Symbol	Parameter	Value	Unit
$R_{th(j-c)}$	Junction to case	20	°C/W
$R_{th(j-a)}^{(1)}$	Junction to ambient	250	°C/W

1. Mounted with minimum recommended pad size, PC board FR4

Table 3. Static electrical characteristics

Symbol	Parameter	Tests conditions	Min.	Typ	Max.	Unit	
$I_R^{(1)}$	Reverse leakage current	$T_j = 25^\circ C$	$V_R = V_{RRM}$		0.015	0.075	mA
		$T_j = 85^\circ C$			0.90	4.50	
		$T_j = 25^\circ C$	$V_R = 10 V$		0.005	0.035	
		$T_j = 85^\circ C$			0.45	2.50	
		$T_j = 25^\circ C$	$V_R = 5 V$		0.003	0.025	
		$T_j = 85^\circ C$			0.30	1.60	
$V_F^{(1)}$	Forward voltage drop	$T_j = 25^\circ C$	$I_F = 1 A$		0.38	0.43	V
		$T_j = 85^\circ C$			0.32	0.37	
		$T_j = 25^\circ C$	$I_F = 2 A$		0.42	0.47	
		$T_j = 85^\circ C$			0.37	0.42	
		$T_j = 25^\circ C$	$I_F = 3 A$		0.46	0.53	
		$T_j = 85^\circ C$			0.42	0.49	
		$T_j = 25^\circ C$	$I_F = 4 A$		0.50	0.60	
		$T_j = 85^\circ C$			0.46	0.56	

1. Pulse test: = 380 μs , $\delta < 2\%$

To evaluate the conduction losses use the following equation: $P = 0.32 \times I_{F(AV)} + 0.05 I_{F(RMS)}^2$

Figure 1. Conduction losses versus average current

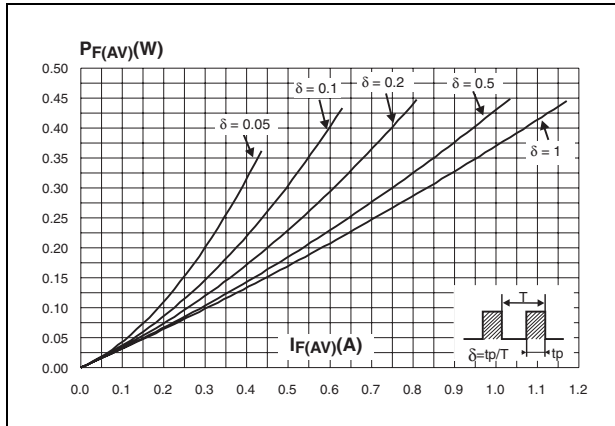

Figure 2. Average forward current (delta = 0.5) versus ambient temperature

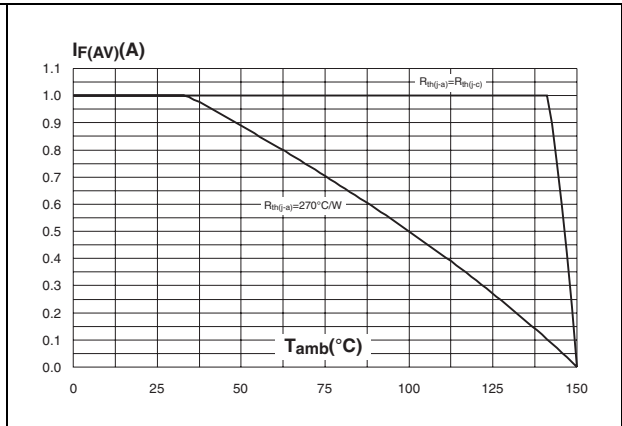

Figure 3. Normalized avalanche power derating versus pulse duration

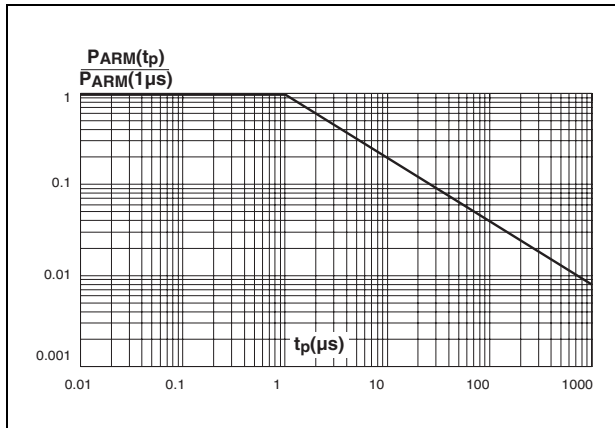

Figure 4. Normalized avalanche power derating versus junction temperature

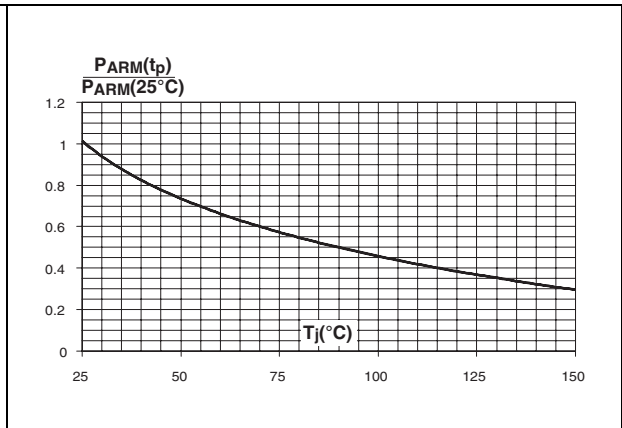

Figure 5. Reverse leakage current versus junction temperature (typical values)

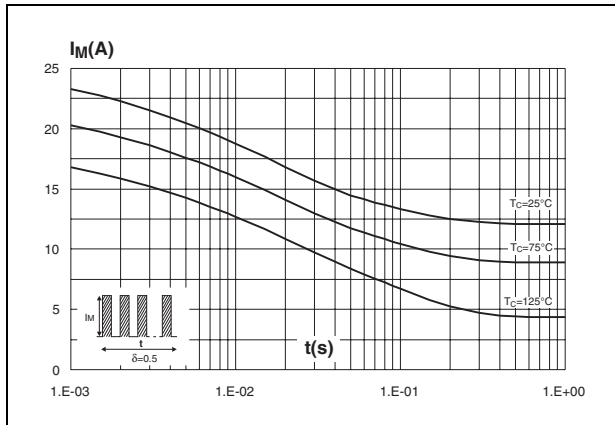

Figure 6. Reverse leakage current versus reverse voltage applied (typical values)

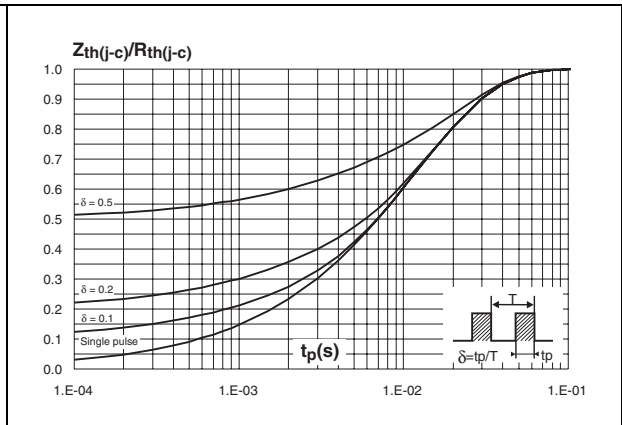

Figure 7. Reverse leakage current versus reverse voltage applied (typical values)

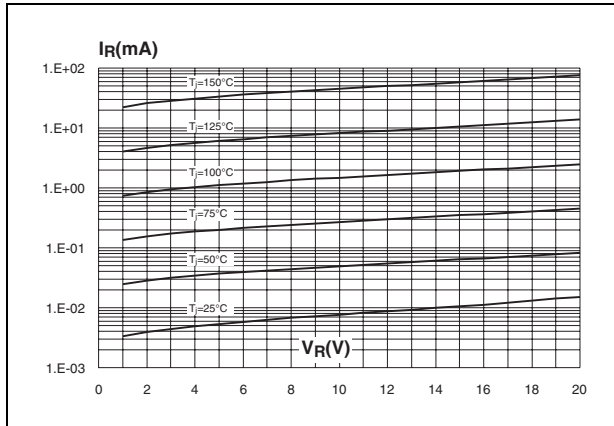

Figure 8. Reverse leakage current versus junction temperature (typical values)

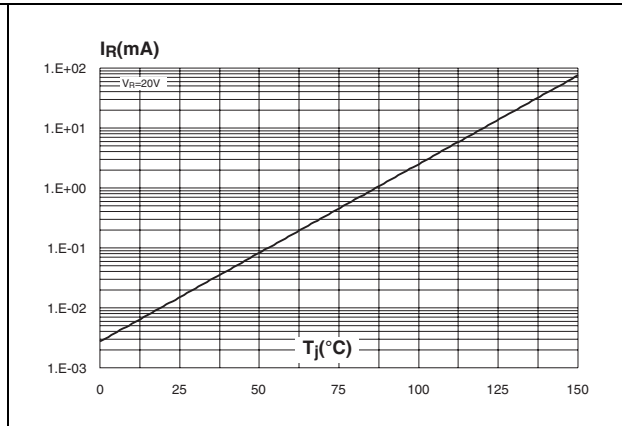

Figure 9. Junction capacitance versus reverse voltage applied (typical values)

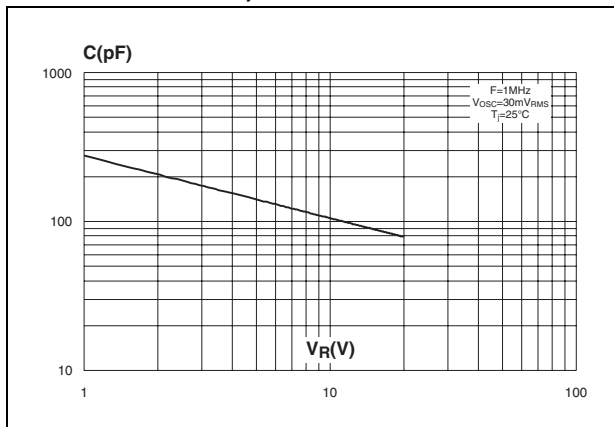

Figure 10. Forward voltage drop versus forward current

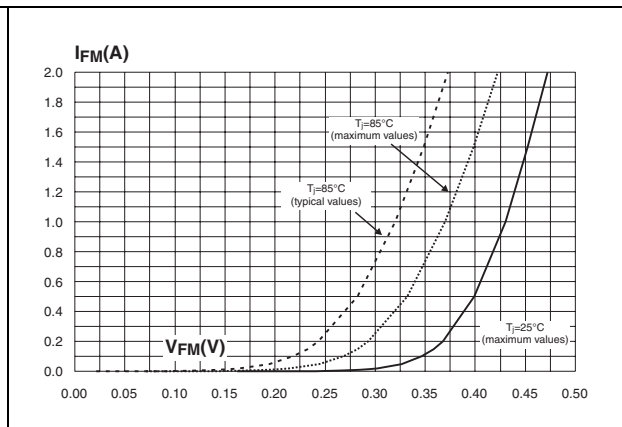
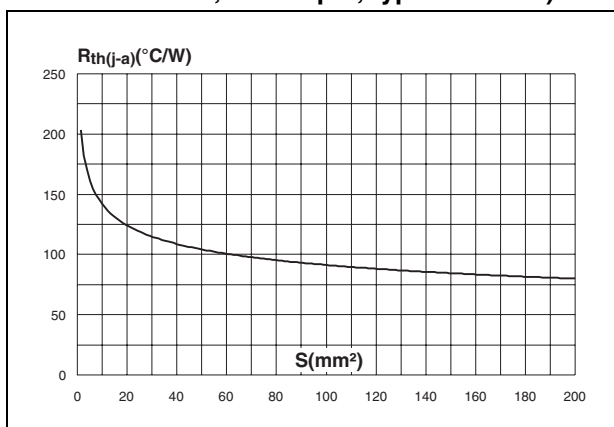

Figure 11. Thermal resistance junction to ambient versus copper surface under tab (epoxy printed board FR4, Cu=35 μm, typical values)



2 Package information

Table 4. STmite flat dimensions

Ref.	Dimensions					
	Millimeters			Inches		
	Min.	Typ.	Max.	Min.	Typ.	Max.
A	0.80	0.85	0.95	0.031	0.033	0.037
b	0.40	0.55	0.65	0.016	0.022	0.026
b2	0.70	0.85	1.00	0.027	0.033	0.039
c	0.10	0.15	0.25	0.004	0.006	0.009
D	1.75	1.90	2.05	0.069	0.075	0.081
E	3.60	3.80	3.90	0.142	0.150	0.154
E1	2.80	2.95	3.10	0.110	0.116	0.122
L	0.50	0.55	0.80	0.020	0.022	0.031
L1	2.10	2.40	2.60	0.083	0.094	0.102
L2	0.45	0.60	0.75	0.018	0.024	0.030
L3	0.20	0.35	0.50	0.008	0.014	0.020

Figure 12. STmite flat recommended footprint (all dimensions in mm)

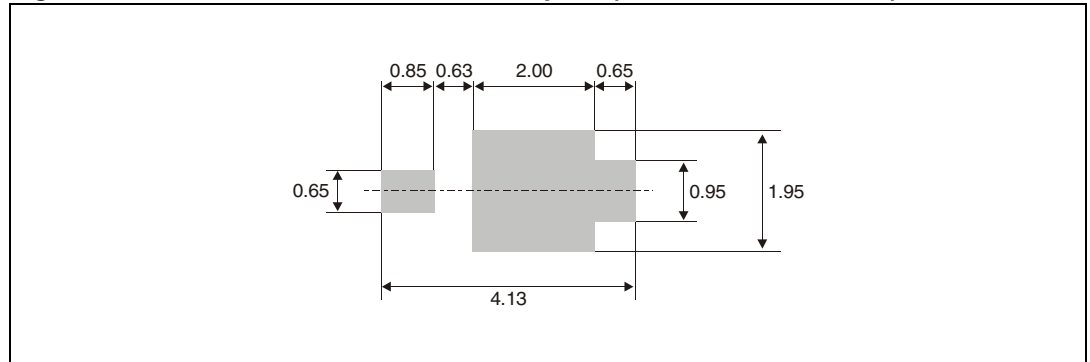

In order to meet environmental requirements, ST offers these devices in ECOPACK® packages. These packages have a Lead-free second level interconnect. The category of second level interconnect is marked on the package and on the inner box label, in compliance with JEDEC Standard JESD97. The maximum ratings related to soldering conditions are also marked on the inner box label. ECOPACK is an ST trademark. ECOPACK specifications are available at: www.st.com.

3 Ordering information

Part number	Marking	Package	Weight	Base qty	Delivery mode
STPS1L20MF	F1L2	STmite flat	16 mg	12000	Tape and reel

4 Revision history

Date	Revision	Changes
21-Aug-2006	1	First issue.

Please Read Carefully:

Information in this document is provided solely in connection with ST products. STMicroelectronics NV and its subsidiaries ("ST") reserve the right to make changes, corrections, modifications or improvements, to this document, and the products and services described herein at any time, without notice.

All ST products are sold pursuant to ST's terms and conditions of sale.

Purchasers are solely responsible for the choice, selection and use of the ST products and services described herein, and ST assumes no liability whatsoever relating to the choice, selection or use of the ST products and services described herein.

No license, express or implied, by estoppel or otherwise, to any intellectual property rights is granted under this document. If any part of this document refers to any third party products or services it shall not be deemed a license grant by ST for the use of such third party products or services, or any intellectual property contained therein or considered as a warranty covering the use in any manner whatsoever of such third party products or services or any intellectual property contained therein.

UNLESS OTHERWISE SET FORTH IN ST'S TERMS AND CONDITIONS OF SALE ST DISCLAIMS ANY EXPRESS OR IMPLIED WARRANTY WITH RESPECT TO THE USE AND/OR SALE OF ST PRODUCTS INCLUDING WITHOUT LIMITATION IMPLIED WARRANTIES OF MERCHANTABILITY, FITNESS FOR A PARTICULAR PURPOSE (AND THEIR EQUIVALENTS UNDER THE LAWS OF ANY JURISDICTION), OR INFRINGEMENT OF ANY PATENT, COPYRIGHT OR OTHER INTELLECTUAL PROPERTY RIGHT.

UNLESS EXPRESSLY APPROVED IN WRITING BY AN AUTHORIZED ST REPRESENTATIVE, ST PRODUCTS ARE NOT RECOMMENDED, AUTHORIZED OR WARRANTED FOR USE IN MILITARY, AIR CRAFT, SPACE, LIFE SAVING, OR LIFE SUSTAINING APPLICATIONS, NOR IN PRODUCTS OR SYSTEMS WHERE FAILURE OR MALFUNCTION MAY RESULT IN PERSONAL INJURY, DEATH, OR SEVERE PROPERTY OR ENVIRONMENTAL DAMAGE. ST PRODUCTS WHICH ARE NOT SPECIFIED AS "AUTOMOTIVE GRADE" MAY ONLY BE USED IN AUTOMOTIVE APPLICATIONS AT USER'S OWN RISK.

Resale of ST products with provisions different from the statements and/or technical features set forth in this document shall immediately void any warranty granted by ST for the ST product or service described herein and shall not create or extend in any manner whatsoever, any liability of ST.

ST and the ST logo are trademarks or registered trademarks of ST in various countries.

Information in this document supersedes and replaces all information previously supplied.

The ST logo is a registered trademark of STMicroelectronics. All other names are the property of their respective owners.

© 2006 STMicroelectronics - All rights reserved

STMicroelectronics group of companies

Australia - Belgium - Brazil - Canada - China - Czech Republic - Finland - France - Germany - Hong Kong - India - Israel - Italy - Japan - Malaysia - Malta - Morocco - Singapore - Spain - Sweden - Switzerland - United Kingdom - United States of America

www.st.com