

Silicon NPN Power Transistors

2SC3890

DESCRIPTION

- With TO-220F package
- High voltage
- High speed switching

APPLICATIONS

- For switching regulator and general purpose applications

PINNING

PIN	DESCRIPTION
1	Base
2	Collector
3	Emitter

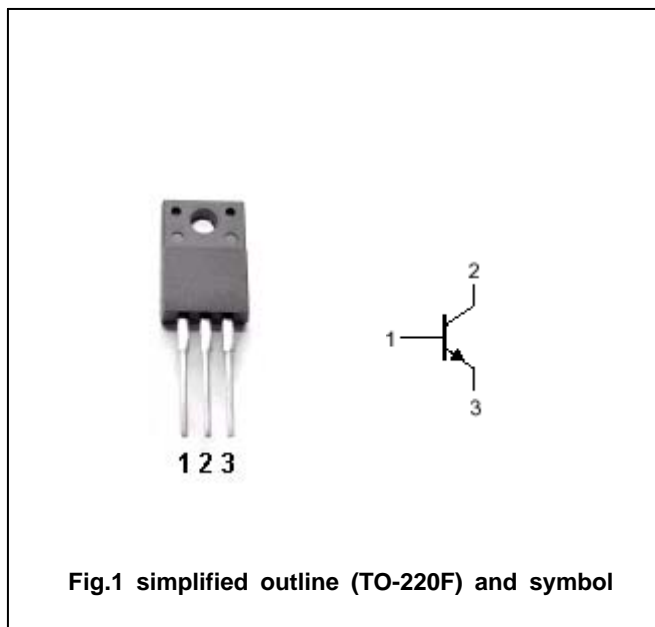

Absolute maximum ratings (Ta=25°C)

SYMBOL	PARAMETER	CONDITIONS	VALUE	UNIT
V_{CBO}	Collector-base voltage	Open emitter	500	V
V_{CEO}	Collector-emitter voltage	Open base	400	V
V_{EBO}	Emitter-base voltage	Open collector	10	V
I_C	Collector current		7	A
I_{CM}	Collector current-peak		14	A
I_B	Base current		2	A
P_C	Collector dissipation	$T_C=25^\circ\text{C}$	30	W
T_j	Junction temperature		150	$^\circ\text{C}$
T_{stg}	Storage temperature		-55~150	$^\circ\text{C}$

Silicon NPN Power Transistors

2SC3890

CHARACTERISTICS

T_j=25°C unless otherwise specified

SYMBOL	PARAMETER	CONDITIONS	MIN	TYP.	MAX	UNIT
V _{(BR)CEO}	Collector-emitter breakdown voltage	I _C =25mA ; I _B =0	400			V
V _{CEsat}	Collector-emitter saturation voltage	I _C =3A; I _B =0.6A			0.5	V
V _{BEsat}	Base-emitter saturation voltage	I _C =3A ; I _B =0.6A			1.3	V
I _{CBO}	Collector cut-off current	V _{CB} =500V; I _E =0			100	μ A
I _{EBO}	Emitter cut-off current	V _{EB} =10V; I _C =0			100	μ A
h _{FE}	DC current gain	I _C =3A ; V _{CE} =4V	10		30	
f _T	Transition frequency	I _C =0.5A ; V _{CE} =12V		10		MHz
C _{OB}	Collector output capacitance	f=1MHz; V _{CB} =10V		50		pF

Switching times

t _{on}	Turn-on time	I _C =3.0A; I _{B1} =0.3A; I _{B2} =-0.6A V _{CC} =200V , R _L =66 Ω			1.0	μ s
t _{stg}	Storage time				3.0	μ s
t _f	Fall time				0.5	μ s

Silicon NPN Power Transistors

2SC3890

PACKAGE OUTLINE

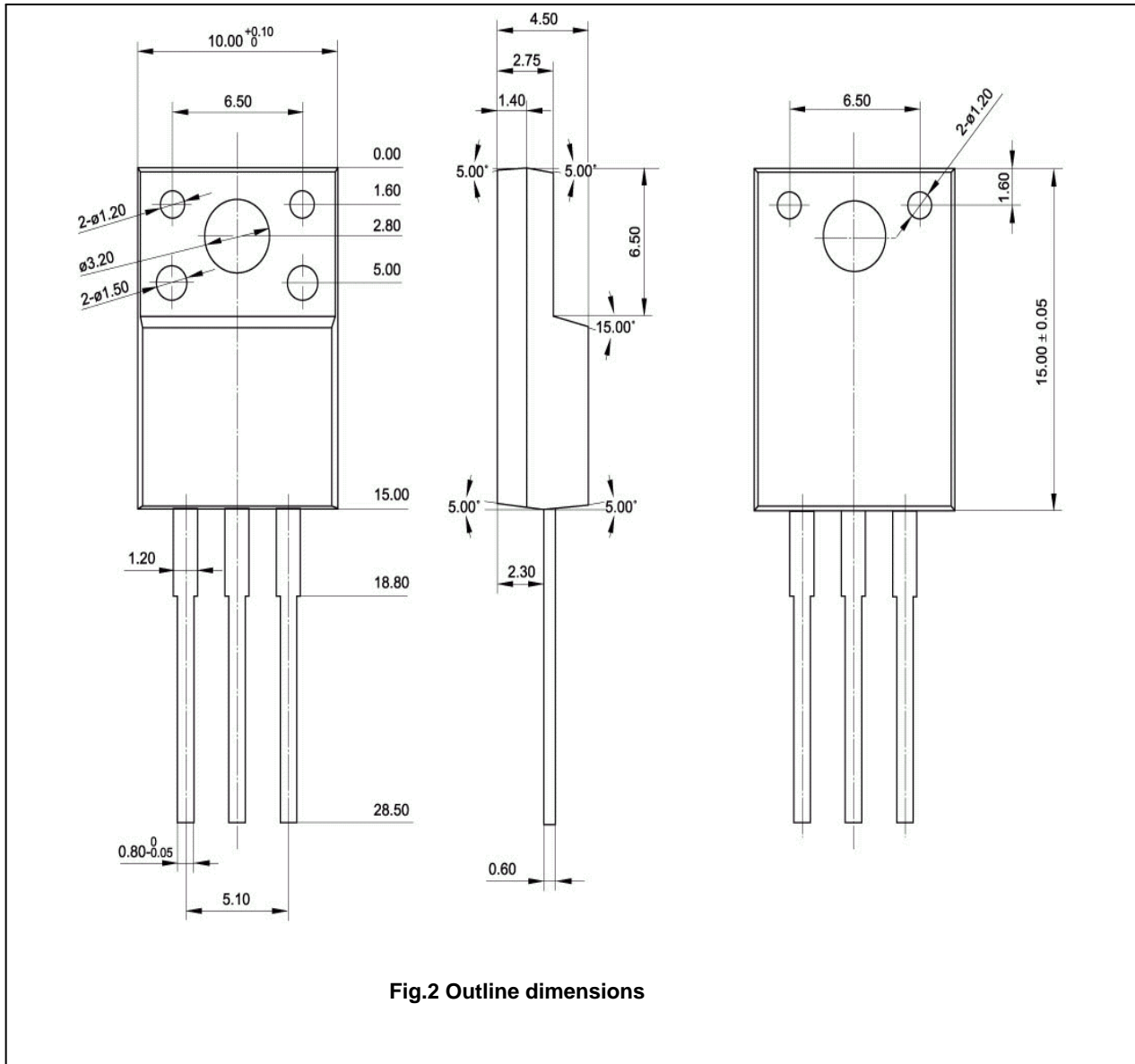

Silicon NPN Power Transistors

2SC3890

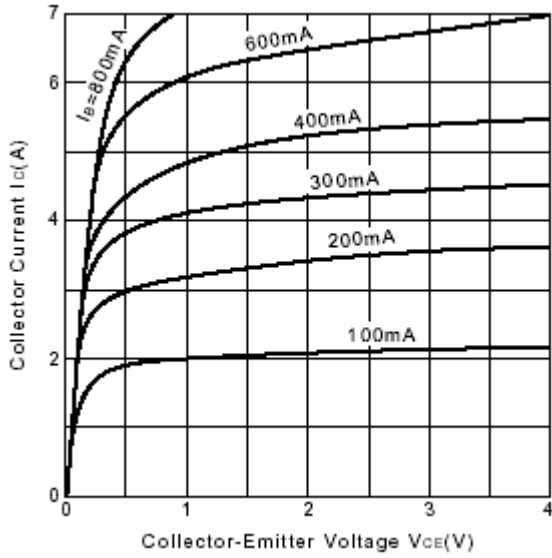

Fig.3 Static Characteristic

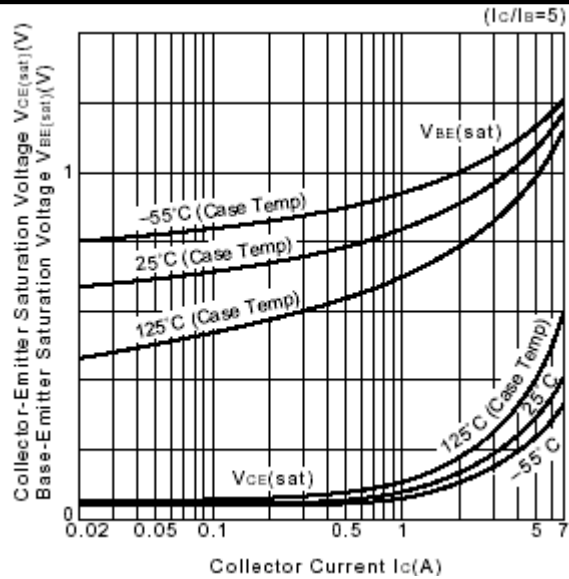

Fig.4 Base-Emitter Saturation Voltage
Collector-Emitter Saturation Voltage

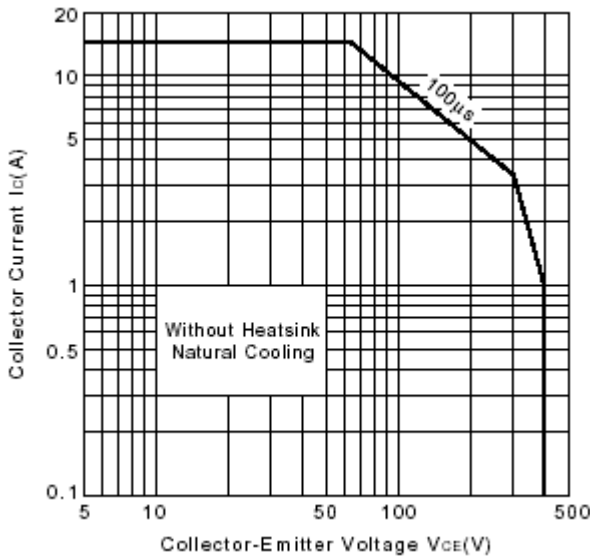

Fig.5 Safe Operating Area

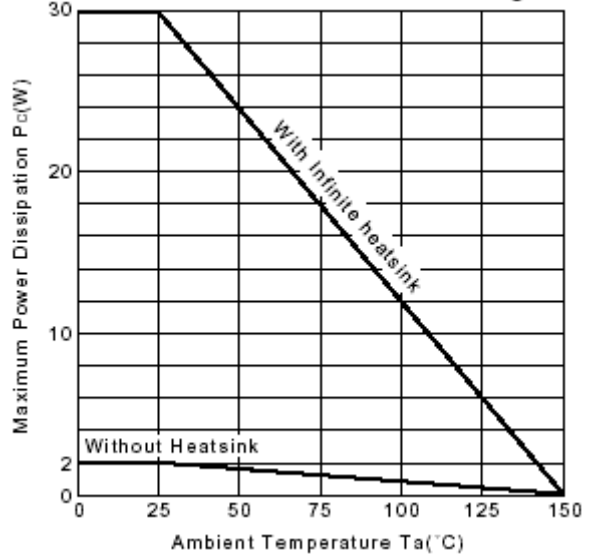

Fig.6 Pc-Ta Derating

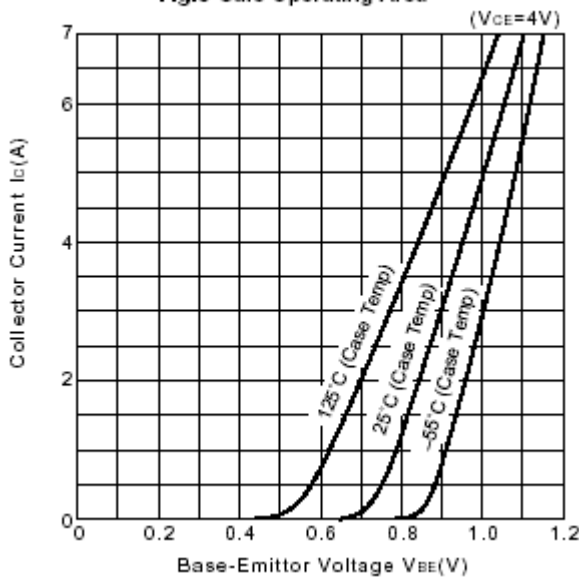

Fig.7 I_C-V_{BE}

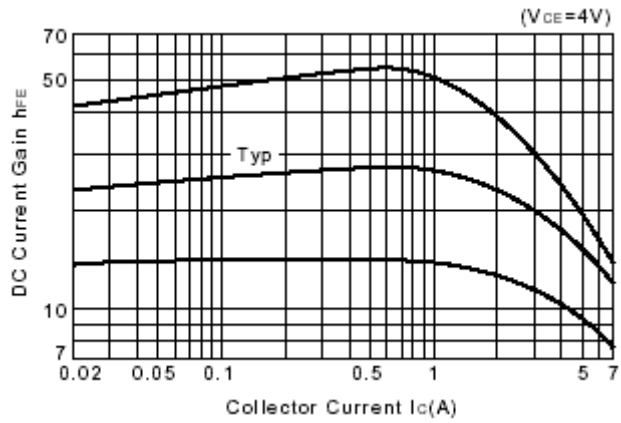

Fig.8 DC current Gain