

Full Color Chip LED With Right Angle Lens

Features

- Package in 8mm tape on 7" diameter reel
- Compatible with automatic placement equipment
- Compatible with infrared and vapor phase reflow solder process
- ESD protection on Blue and Green Chips
- RoHS compliance

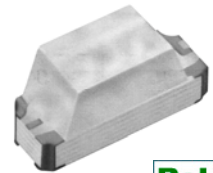

QMLPRFRA



Applications

- Automotive: Backlighting in dashboard and switch
- Telecommunication: indicator and backlighting in telephone and fax
- Flat backlight for LCD, switches and symbols
- General use

Descriptions

- The SMD series enables smaller board size, higher packing density, reduced storage space, and small equipment
- Besides, light weight makes them ideal for miniature applications

Device Selection Guide

Part No.	Chip			Lens Color
	Color Code	Material	Emitted Color	
TFPR-QTB1FA2714	Q	AlInGaN	Super Red	Water Clear
	T	InGaN	True Green	
	B	InGaN	Blue	

Full Color Chip LED with Right Angle Lens

TFPR-QTB1FA2714

Absolute Maximum Ratings (Ta=25°C)

Parameter	Symbol	Value	Unit
Reverse Voltage	VR	5	V
Forward Current	IF	Super Red:25	mA
		True Green:25	
		Blue:25	
Peak Forward Current (Duty 1/10 @1KHz)	IFP	Super Red:60	mA
		True Green:100	
		Blue:100	
Electrostatic Discharge (HBM)	ESD	Super Red:2000	V
		True Green:2000	
		Blue:2000	
Power Dissipation	Pd	Super Red:60	mW
		True Green:110	
		Blue:110	
Soldering Temperature	Tsol	260 for 5 seconds	°C
Operating Temperature	Topr	-40 ~ +85	°C
Storage Temperature	Tstg	-40 ~ +90	°C

Full Color Chip LED with Right Angle Lens

TFPR-QTB1FA2714

Electro-Optical Characteristics:

Parameter	Symbol	Emitted Color	Min.	Typ.	Max.	Unit	Condition
Luminous Intensity	IV	Super Red	45	72	----	mcd	IF =20mA
		True Green	112	180	----		
		Blue	28.5	45	----		
Viewing Angle	2θ1/2	----	----	120	----	deg	
Peak Wavelength	λp	Super Red	----	632	----	nm	
		True Green	----	518	----		
		Blue	----	468	----		
Dominant Wavelength	λd	Super Red	615	----	630	nm	
		True Green	510	----	540		
		Blue	460	----	480		
Spectrum Radiation Bandwidth	Δλ	Super Red	----	20	----	nm	
		True Green	----	35	----		
		Blue	----	35	----		
Forward Voltage	VF	Super Red	----	2.0	2.4	V	
		True Green	----	3.4	3.9		
		Blue	----	3.4	3.9		
Reverse Current	IR	Super Red	----	----	10	μA	VR=5V
		True Green	----	----	----		
		Blue	----	----	----		

Notes: Tolerance of Luminous Intensity ±10%

Tolerance of Dominant wavelength ±1nm

Tolerance of Forward Voltage ±0.05V

Full Color Chip LED with Right Angle Lens

TFPR-QTB1FA2714

Typical Electro-Optical Characteristics Curves (Red)

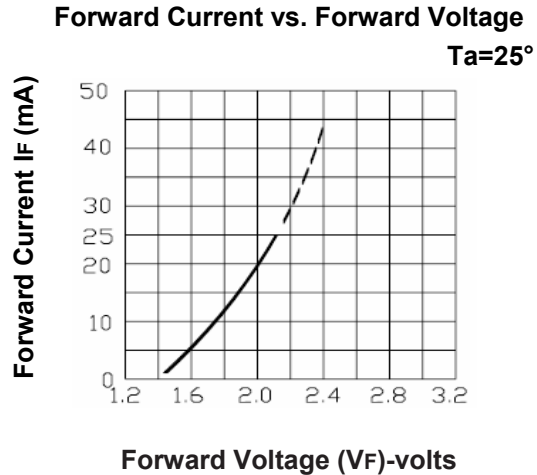
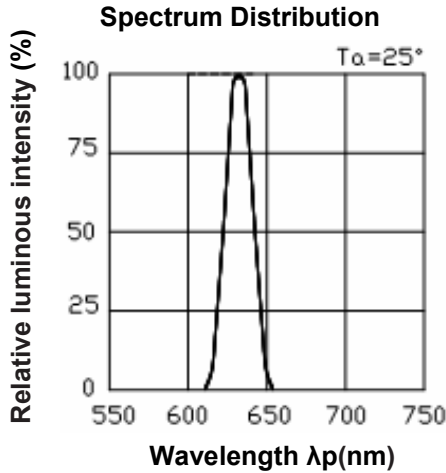

Luminous Intensity vs. Ambient Temperature

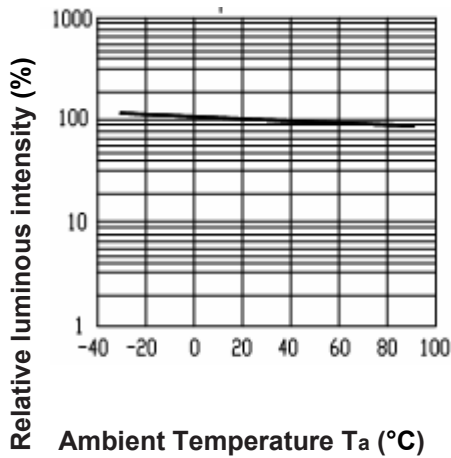

Luminous Intensity vs. Forward Current
 $T_a = 25^\circ$

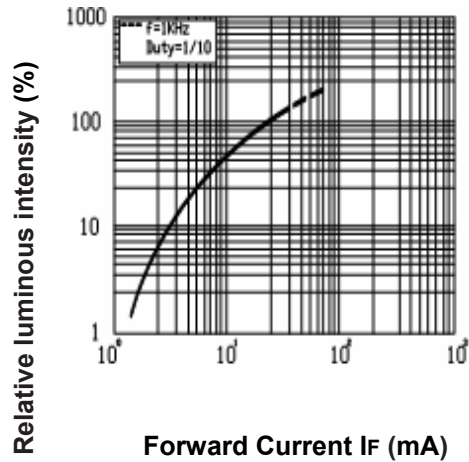

Forward Current Derating Curve

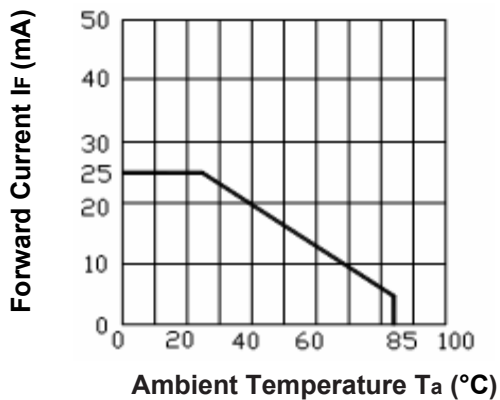

Radiation Diagram ($T_a = 25^\circ\text{C}$)

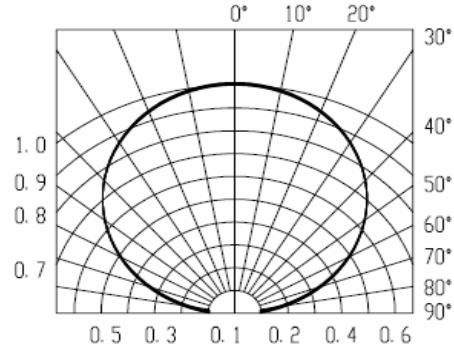

Full Color Chip LED with Right Angle Lens

TFPR-QTB1FA2714

Typical Electro-Optical Characteristics Curves (True Green)

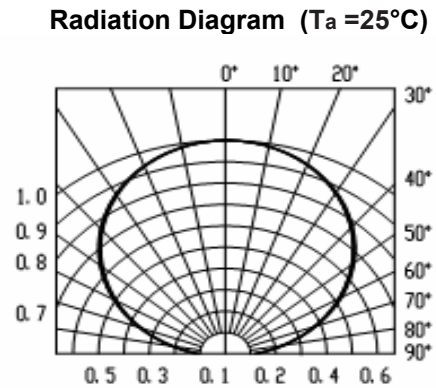
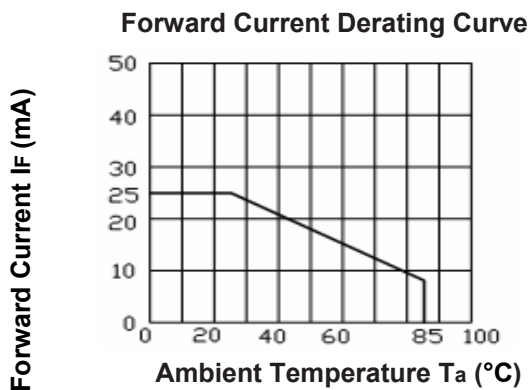
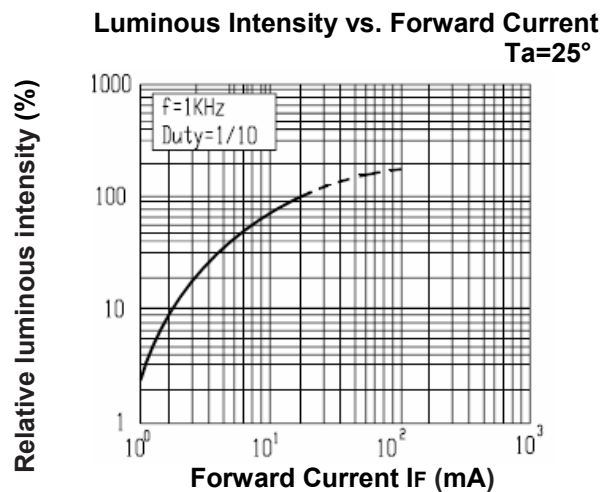
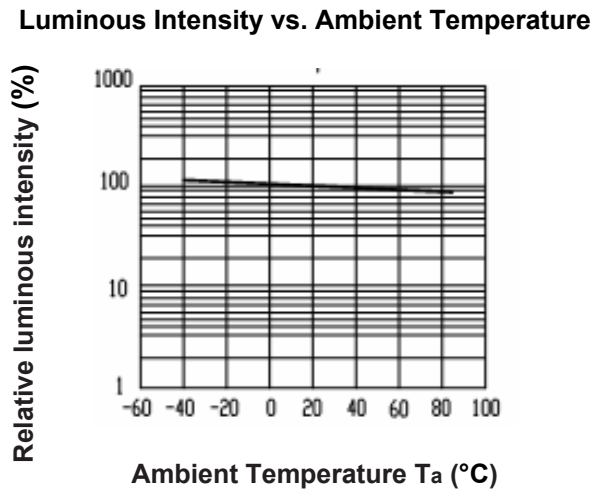
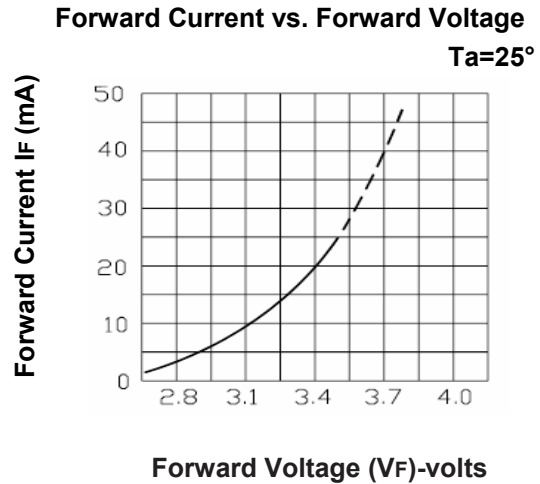
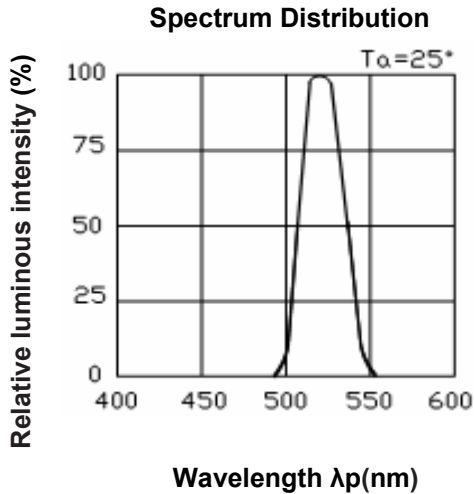

Full Color Chip LED with Right Angle Lens

TFPR-QTB1FA2714

Typical Electro-Optical Characteristics Curves (Blue)

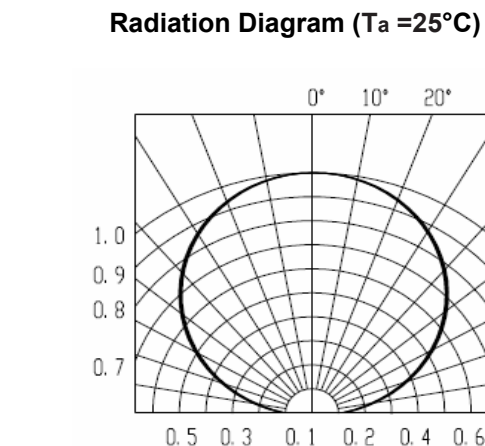
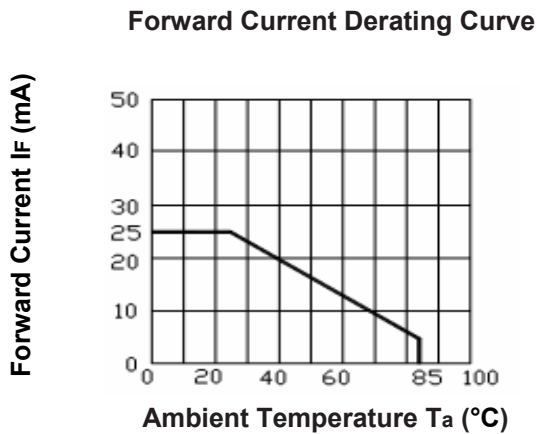
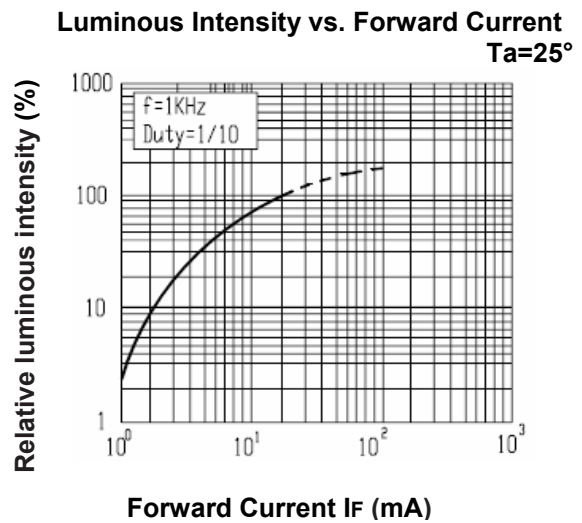
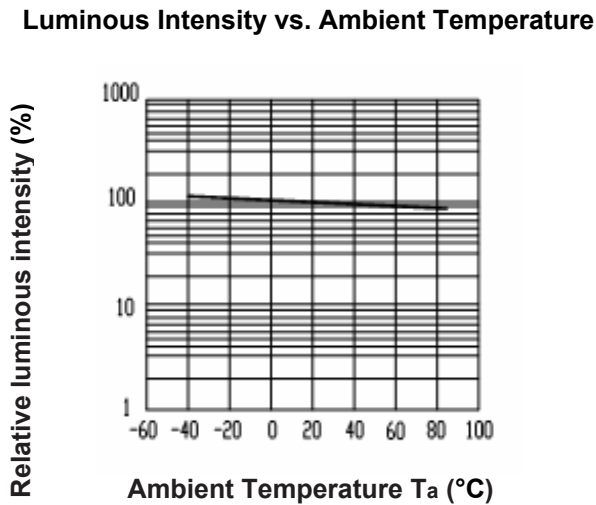
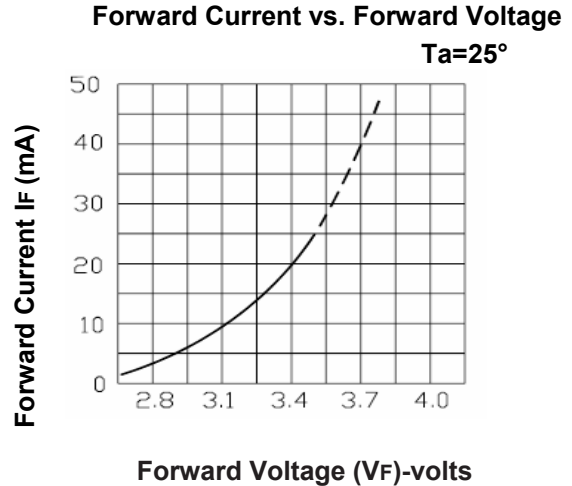
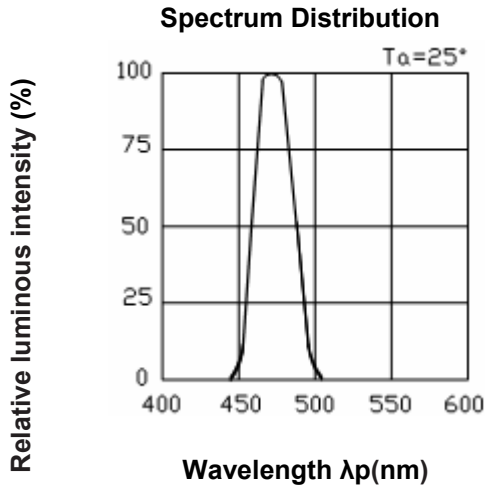

Full Color Chip LED with Right Angle Lens

TFPR-QTB1FA2714

Reliability Test Items and Conditions

The reliability of products shall be satisfied with items listed below.

Confidence level: 90%,

LTPD: 10%

No.	Item	Test Conditions	Test Hours/Cycle	Sample Size	Ac/Re
1	Reflow Soldering	Temp : 240°C ±5°C for 5sec	6 min	22 PCS	0/1
2	Temperature Cycle	H : +100°C for 15min ┆ 5 min L : -40°C for 15min	300 Cycles	22 PCS	0/1
3	Thermal Shock	H : +100°C for 5min ┆ 10 sec L : -10°C for 5min	300 Cycles	22 PCS	0/1
4	High Temperature Storage	Temp : 100°C	1000 Hrs	22 PCS	0/1
5	Low Temperature Storage	Temp : -40°C	1000 Hrs	22 PCS	0/1
6	DC Operating Life	If = 20 m A	1000 Hrs	22 PCS	0/1
7	High Temperature / High Humidity	85°C / R.H85%	1000 Hrs	22 PCS	0/1

Full Color Chip LED with Right Angle Lens

TFPR-QTB1FA2714

Package Outline Dimensions

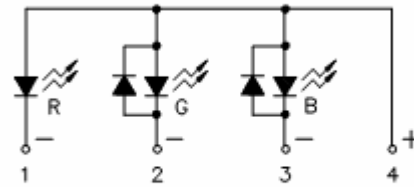
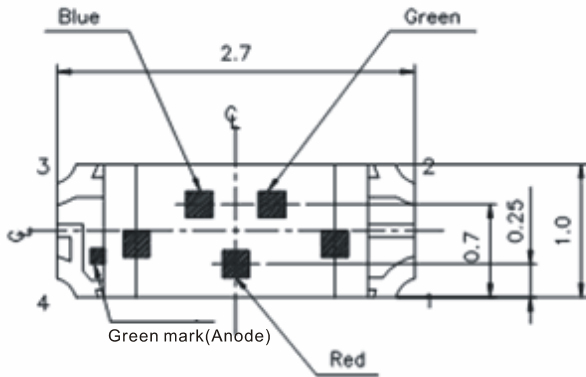

Polarity

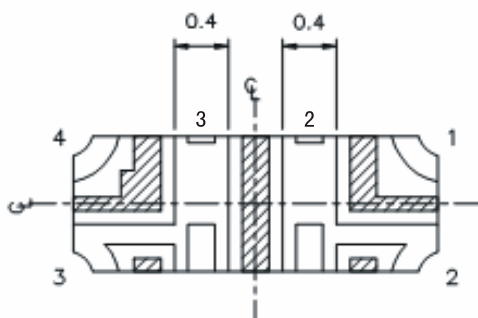
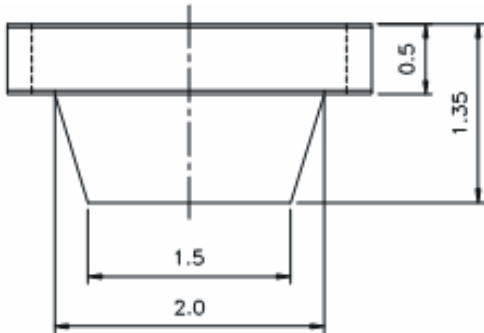

For reflow soldering (propose)

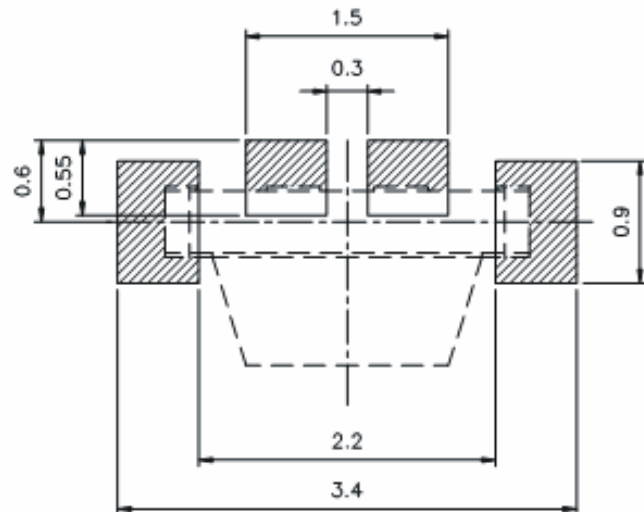

Note: The tolerances unless mentioned is $\pm 0.1\text{mm}$, Unit = mm

Full Color Chip LED with Right Angle Lens

TFPR-QTB1FA2714

Carrier Tape Dimensions: Loaded quantity 2000pcs per reel

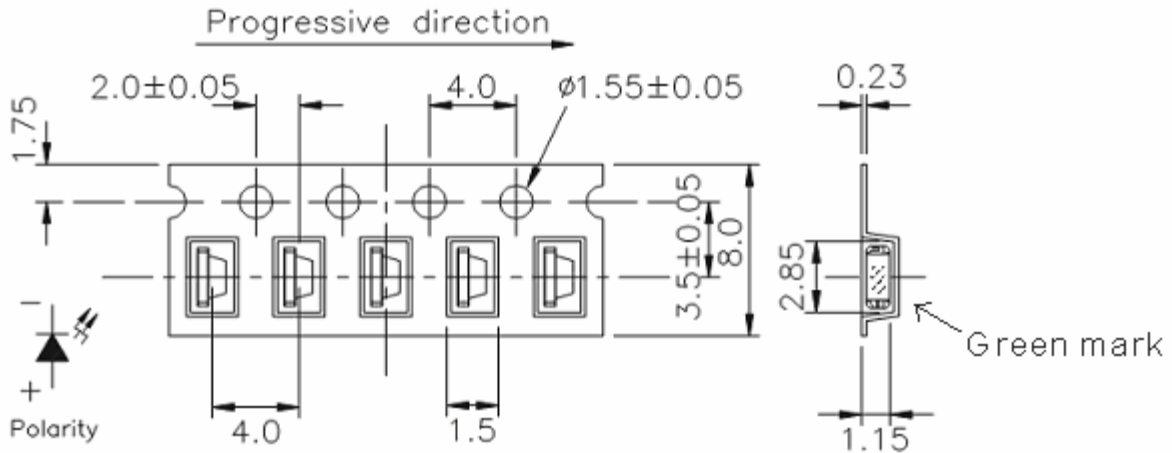

Note: The tolerances unless mentioned is $\pm 0.1\text{mm}$, Unit = mm

Moisture Resistant Packaging

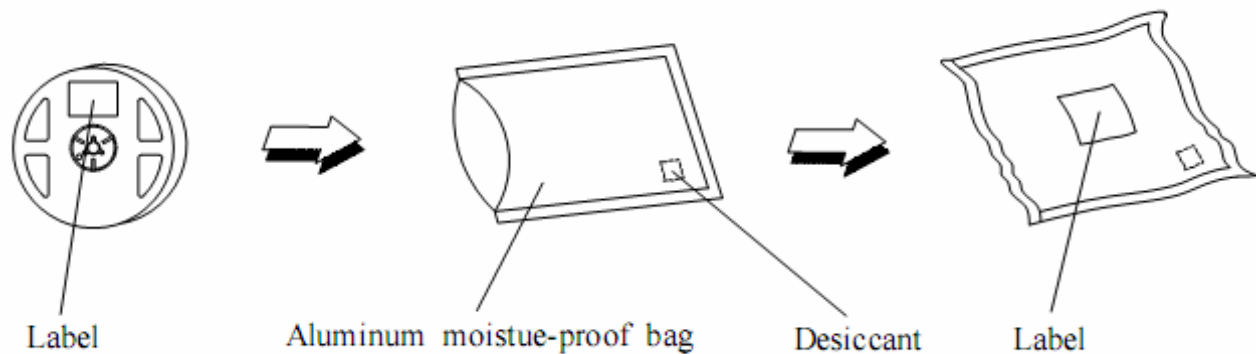

Full Color Chip LED with Right Angle Lens

TFPR-QTB1FA2714

Ordering Information

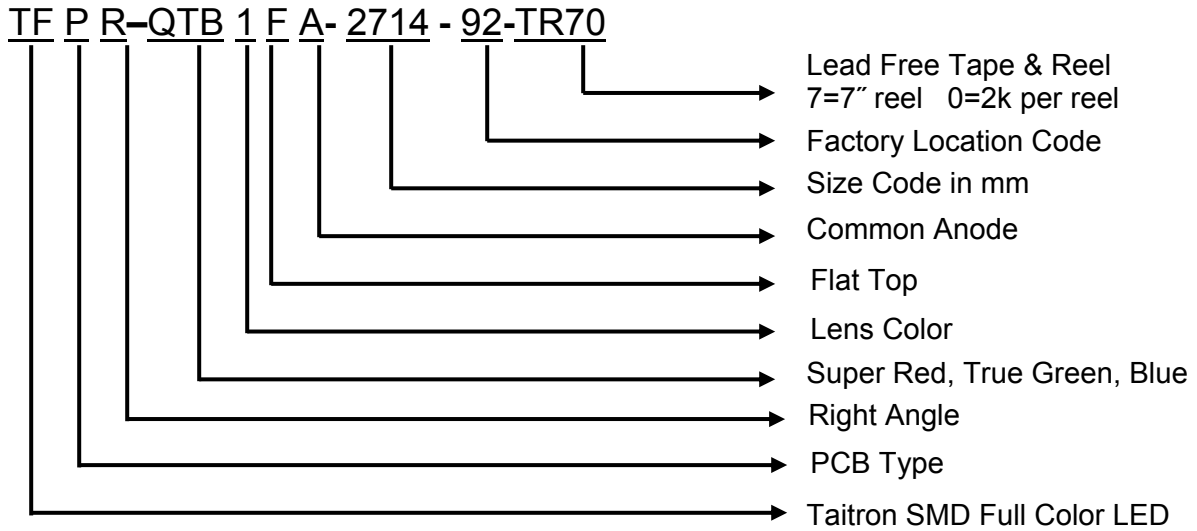

Label Explanation

CAT: Luminous Intensity Rank

HUE: Dom. Wavelength Rank

REF: Forward Voltage Rank

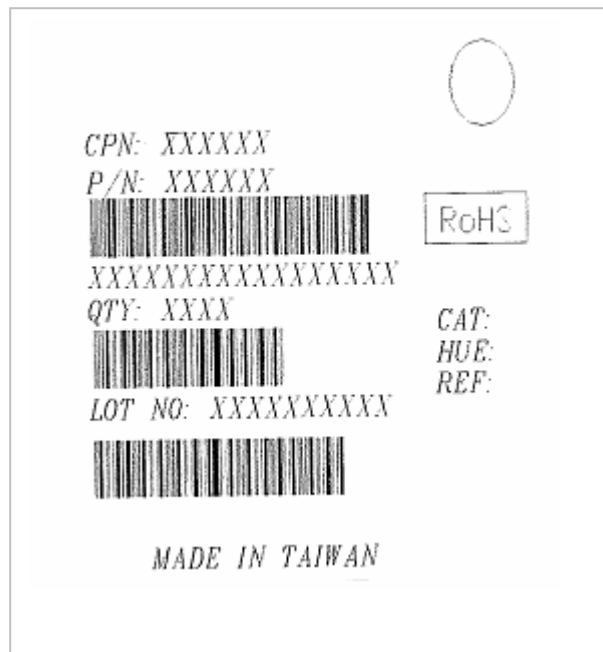

Full Color Chip LED with Right Angle Lens

TFPR-QTB1FA2714

How to contact us

US HEADQUARTER

28040 WEST HARRISON PARKWAY, VALENCIA, CA 91355-4162

Tel: (800) TAITRON (800) 247-2232 (661) 257-6060

Fax: (800) TAITFAX (800) 824-8329 (661) 257-6415

Email: taitron@taitroncomponents.com

Http://www.taitroncomponents.com

TAITRON COMPONENTS MEXICO, S.A .DE C.V.

BOULEVARD CENTRAL 5000 INTERIOR 5 PARQUE INDUSTRIAL ATITALAQUIA, HIDALGO

C.P. 42970 MEXICO

Tel: +52-55-5560-1519

Fax: +52-55-5560-2190

TAITRON COMPONETS INCORPORATED E REPRESENTAÇÕES DO BRASIL LTDA

RUA DOMINGOS DE MORAIS, 2777, 2.ANDAR, SALA 24 SAÚDE - SÃO PAULO-SP 04035-001
BRAZIL

Tel: +55-11-5574-7949

Fax: +55-11-5572-0052

TAITRON COMPONETS INCORPORATED, SHANGHAI REPRESENTATIVE OFFICE

CROSS REGION PLAZA, 899 LINGLING ROAD, SUITE 18C, SHANGHAI, 200030, CHINA

Tel: +86-21-54249942

Fax: +86-21-5424-9931