



Description

The Atlas 5 is a positive mode, tongue operated guard locking interlock switch that locks a machine guard closed until power is isolated and ensures that it remains isolated while the guard is open. The guard may only be opened when a signal is applied to the internal solenoid which releases the lock mechanism. A heavy-duty switch, the Atlas 5 locking mechanism withstands forces up to 5500N (1236lbs.) and the die-cast alloy housing is ideal for use in harsh environments. A unique feature of the Atlas 5 is its patented self-aligning head that tolerates actuator or guard misalignment, making it particularly useful for heavy machine guards.

The Atlas 5 is designed for machines that do not stop immediately or where premature interruption of the machine could cause damage to tooling and components or cause an additional hazard. With 2 safety (N.C.) contacts and 2 auxiliary (N.O.) contact, Atlas 5 is ideal for PLC controlled machines.

Features

- Mechanical lock
- High locking force—5500N (1236lbs.)
- Heavy duty die-cast alloy housing ideal for harsh environments
- Patented self-aligning head tolerates actuator misalignment

Specifications



Standards	EN954-1, ISO13849-1, IEC/EN60204-1, NFPA79, EN1088, ISO14119, IEC/EN60947-5-1, ANSI B11.19, AS4024.1
Category	Cat. 1 Device per EN954-1 Dual channel interlocks suitable for Cat. 3 or 4 systems
Approvals	CE marked for all applicable directives, cULus and CSA
Safety Contacts	Atlas 5 2 N.C. direct opening action 1 N.O. direct opening action
Atlas 5 trapped key (left hand)	2 N.C. direct opening action 1 N.O. direct opening action
Utilization Cat.	AC (Ue) (Ie) DC
	AC 15 500V 250V 100V 1A 2A 5A 250V 0.5A, 24V 2A
Maximum Switched Current/ Volt/Load	500V 500VA
Thermal Current (Ith)	10A
Min Current	5V. 5mA DC
Safety Contact Gap	> 2mm contact block
Rtd. Insulation Voltage	(Ui) 500V
Rtd. Impulse withstand Volt	(Uimp) 2500V
Auxiliary Contacts	1 N.O.
Actuator Travel for Positive Opening	8mm (.31in.)
Break Contact Min Force	12N (2.7 lbs)
Max Actuation Speed	160mm per sec (6.3 in. per sec)
Max Actuation Frequency	2 Cycle per sec
Case Material	Die cast alloy
Actuator Material	Stainless Steel
Protection	IP65
Conduit Entry	3 x M20 or 3 x 1/2in NPT or quick disconnect
Operating Temperature	-10°C to +60°C (14°F to +140°F)
Fixing	4 x M5
Mechanical Life	1,000,000 operations
Electrical Life	1,000,000 operations
Weight	1200g (2.65lbs)
Colour	Red
Max Holding Force	5500N (1236lbs)
Min Operating Radius	300mm end entry, 800mm entry front
Power Supply	24V AC/DC or 110V AC or 230V AC (solenoid)
Solenoid Power	13W typical 100% ED
Solenoid Rating	100% duty

Interlock Switches
Guard Locking Switches
 Atlas 5

Product Selection

Type		Actuator	Contacts		Solenoid Voltage	Catalogue Number		
			Safety	Aux.		M20 Conduit	1/2in NPT	Quick Disconnect
Atlas 5	Standard	Standard	2 N.C.	1 N.O.	24V AC/DC	440G-L07264	440G-L07258	440G-L07298
					110V AC/DC	440G-L07263	440G-L07257	440G-L07299
					230V AC/DC	440G-L07262	440G-L07256	440G-L07300
	LH Key Lock				24V AC/DC	440G-L07255	440G-L07249	440G-L07301
					110V AC/DC	440G-L07254	440G-L07248	440G-L07302
					230V AC/DC	440G-L07253	440G-L07247	440G-L07303
		M23 mating cable 2m (6.5ft). See page 15-13 for details and additional lengths.						889M-F12AH-2

Accessories

Description	For Dimensions refer to page	Catalogue Number
 <p>Standard Actuator</p>	14-3	440G-A07136
 <p>Replacement End Cap</p>	14-3	440G-A07180
 <p>Fully Flex Actuator</p>	14-3	440G-A07269

Interlock Switches

Guard Locking Switches

Atlas 5

Approximate Dimensions—mm (inches)

Dimensions are not intended to be used for installation purposes.

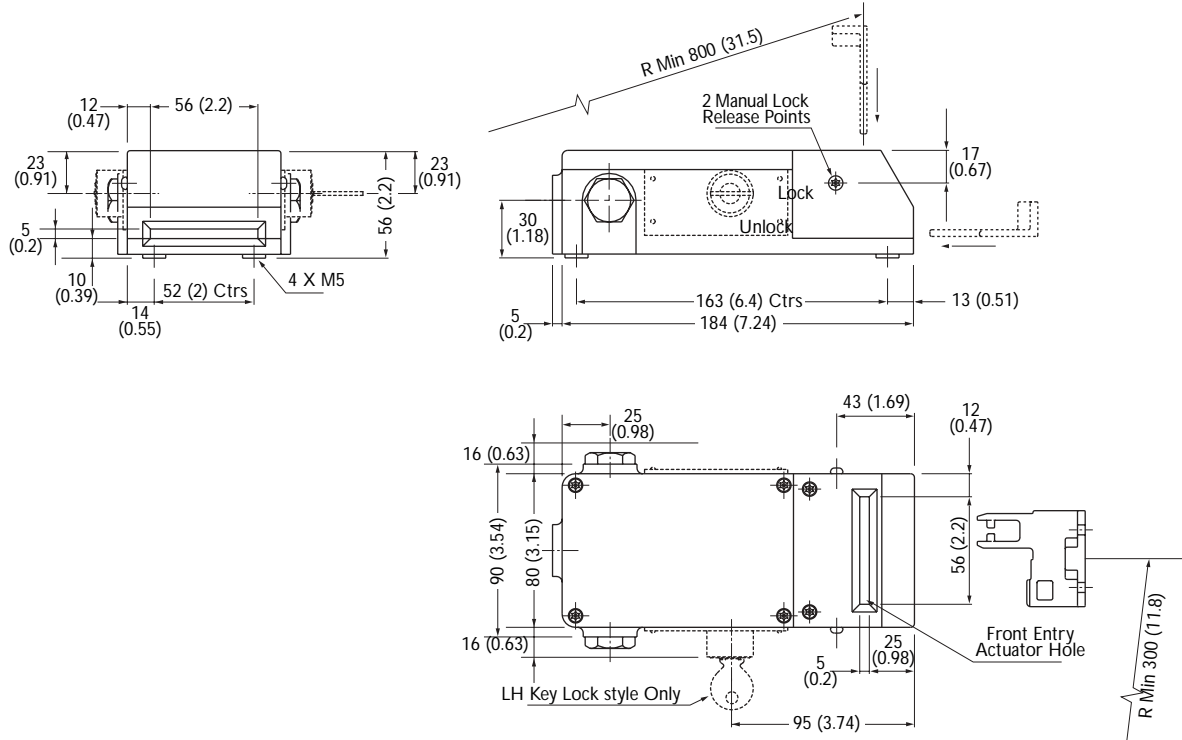

Typical Wiring Diagrams

Guard Open—Solenoid De-energized

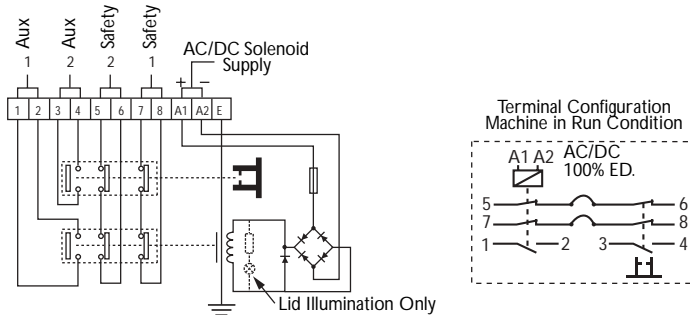

Connector Pinout	Terminal	Contact	Contact Action □ Contact Open ■ Contact Closed Actuator withdrawal distance from full insertion
	1	A1	
	3	A2	Power
	4	5	N.C.
	6	6	N.C.
	7	7	N.C.
	8	8	N.C.
	9	1	N.O.
	10	2	N.O.
	5	3	N.O.
	2	4	N.O.
12	Ground		

Contact Action

□ Contact Open ■ Contact Closed

Actuator withdrawal distance from full insertion

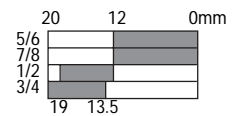

Application Details



CU 1 Timer Unit

Used with Atlas for machines with constant overruns. Gives a timed delay to the lock/release signal. Failsafe and adjustable to a range of times from 0.1 seconds up to 40 minutes. For more details, see the Safety monitoring relay section in this catalogue.



CU 2 Stop Motion Detector Unit

Used with Atlas for machines with constant or variable over run. Gives a timed delay to the lock/release signal. Fail safe and adjustable to a range of times from 0.1 seconds up to 40 minutes. For more details, see the Monitoring Safety Relay section in this catalogue.



Minotaur MSR6R/T Monitoring Safety Relay Unit

Ensures a maximum level of safety by monitoring all wiring in the safety circuit including switches and contactors.

Any fault and the power to the machine is switched off.

Other Minotaur units are available, see the Safety monitoring relay section in this catalogue.