

## FEATURES

- -55° to +125°C operation
- 16 to 40 VDC input
- Fully Isolated
- Optocoupler feedback
- Fixed frequency 550 kHz typical
- Topology – Single Ended Flyback
- 50 V for up to 50 ms transient protection
- Inhibit function
- Indefinite short circuit protection
- Up to 74% efficiency

# DC/DC CONVERTERS 28 VOLT INPUT

## MGA SERIES 5 WATT

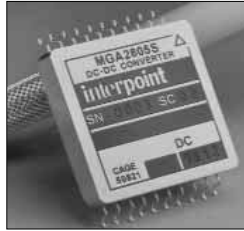

MODELS	
VDC OUTPUT	
SINGLE	DUAL
5	±5
12	±12
15	±15

Size (max.): 1.110 x 1.110 x 0.250 inches (28.19 x 28.19 x 6.35 mm)  
Shown with "Gull Wing" lead option, also available with straight leads. See Section B8, case D, for dimensions and options.

Weight: 15 grams maximum.

Screening: Standard, ES, or 883 (Class H). See Section B9 for screening options, see Section A5 for ordering information.

## DESCRIPTION

The MGA Series™ of DC/DC converters delivers 5 watts of output power from a wide input voltage range of 16 to 40 VDC with up to 74% efficiency. Output models of 5, 12, 15, ±5, ±12 and ±15 VDC meet a variety of system needs. All units withstand transients of up to 50 V for up to 50 milliseconds and operate over the full military temperature range of -55°C to +125°C.

### CONVERTER DESIGN

The MGA converters incorporate flyback topology with a typical constant switching frequency of 500 kHz. Isolation between input and output circuits is provided with a transformer in the forward path and a temperature compensated optical link in the feedback control loop. The feed-forward compensation design delivers an audio rejection of 50 dB, typical, with input ripple as low as 50 mA p-p and output ripple as low as 100 mV p-p. Output filter examples in Figures 3 and 4 provide suggested solutions for systems where very low output ripple is required.

Tightly coupled magnetics minimize cross regulation in the MGA dual output models. Either output can provide up to 80% of the total available output power, providing the opposite output is carrying at least 20% of the total output power.

The converter's short circuit current protection restricts the output current to approximately 115% of the full load output current.

### INHIBIT FUNCTION

The MGA converter's inhibit terminal disables internal switching, resulting in no output and very low quiescent input current. Applying

a TTL low voltage (0.8 V or less) to the inhibit terminal (pin 1) disables the output. Leaving the inhibit terminal unconnected or connecting the inhibit terminal to an open collector gate enables the output. The inhibit terminal has an open circuit voltage of 9 to 11 V. In the inhibit mode the inhibit pin will source a maximum of 4 mA. See "Inhibit Interface," Figure 2.

### MIL-STD-461

Use Interpoint's FMGA-461 EMI filter to pass the CE03 requirements of MIL-STD-461C.

### SURFACE MOUNT PACKAGE

The MGA DC/DC converters can be surface mounted with pick-and-place equipment or manually. It is recommended that the case be attached with flexible epoxy adhesive or silicone which is thermally conductive (>1 watt /meter/°K).

Internal components are soldered with SN96 (melting temperature 221°C) to prevent damage during reflow. Maximum reflow temperature for surface mounting the MGA converter is 220°C for a maximum of 30 seconds. SN60, 62, or 63 are the recommended types of solder. Hand soldering should not exceed 300°C for 10 seconds per pin.

The hermetically sealed metal cases are available in two different lead configurations. See Section B8, cases D1 and D2.

CRANE

interpoint

A CRANE CO. COMPANY

# MGA SERIES 5 WATT

# DC/DC CONVERTERS

**ABSOLUTE MAXIMUM RATINGS**

**Input Voltage**

- 16 to 40 V

**Output Power**

- 5 watts

**Lead Soldering Temperature**

- Reflow 220°C 30 sec. max  
SN60, 62 or 63 recommended solder
- Hand solder 300°C 10 sec. max. per lead

**Storage Temperature Range (Case)**

- -65°C to +150°C

**INHIBIT**

**Inhibit: TTL Open Collector**

- Logic low (output disabled)  
Logic low voltage  $\leq 0.8$  V
- Referenced to input common
- Logic high (output enabled)  
Open collector

**RECOMMENDED OPERATING CONDITIONS**

**Input Voltage Range**

- 16 to 40 VDC continuous
- 50 V for up to 50 msec transient

**Case Operating Temperature (Tc)**

- -55°C to +125°C full power
- -55°C to +135°C absolute

**Derating Output Power/Current (Tc)**

- Linearly from 100% at 125°C to 0% at 135°C

**TYPICAL CHARACTERISTICS**

**Output Voltage Temperature Coefficient**

- 100 ppm/°C typ, 150 ppm/C max

**Current Limit**

- 115% of full load typical

**Isolation**

- Input to output
- Any pin to case except case pins
- 100 megohm minimum at 500 V

**Conversion Frequency**

- 500 kHz typical  
450 kHz. min, 600 kHz max

**Inhibit Pin Voltage (unit enabled)**

- 9 to 11 V

**Electrical Characteristics: 25°C Tc, 28 VDC Vin, 100% load, unless otherwise specified.**

SINGLE OUTPUT MODELS		MGA2805S			MGA2812S			MGA2815S			UNITS
PARAMETER	CONDITIONS	MIN	TYP	MAX	MIN	TYP	MAX	MIN	TYP	MAX	
OUTPUT VOLTAGE	+V <sub>OUT</sub>	4.95	5.0	5.05	11.88	12	12.12	14.85	15	15.15	VDC
OUTPUT CURRENT	V <sub>IN</sub> = 16 to 40 VDC	0	—	1000	0	—	417	0	—	333	mA
OUTPUT POWER	V <sub>IN</sub> = 16 to 40 VDC	—	—	5	—	—	5	—	—	5	W
OUTPUT RIPPLE	10 kHz - 2 MHz	—	250	450	—	100	500	—	100	600	mV p-p
LINE REGULATION	V <sub>IN</sub> = 16 to 40 VDC	—	10	50	—	10	50	—	10	50	mV
LOAD REGULATION	NO LOAD TO FULL	—	10	50	—	10	50	—	10	50	mV
INPUT VOLTAGE	CONTINUOUS	16	28	40	16	28	40	16	28	40	VDC
NO LOAD TO FULL	TRANSIENT 50 ms	—	—	50	—	—	50	—	—	50	V
INPUT CURRENT	NO LOAD	—	27	60	—	29	60	—	31	60	mA
	FULL LOAD	—	—	279	—	—	263	—	—	259	
	INHIBITED	—	3	4	—	3	4	—	3	4	
INPUT RIPPLE	Tc = 25°C	—	50	200	—	50	200	—	50	200	mA p-p
	10 kHz - 10 MHz Tc = -55°C to +125°C	—	75	300	—	75	300	—	75	300	
EFFICIENCY		64	69	—	68	74	—	69	74	—	%
LOAD FAULT <sup>1</sup>	SHORT CIRCUIT POWER DISS.	—	1.5	2.0	—	1.2	1.9	—	1.2	1.8	W
	RECOVERY	—	10	75	—	10	30	—	10	30	ms
STEP LOAD RESPONSE <sup>2</sup>	50% - 100% - 50% LOAD TRANSIENT	-500	200	500	-750	300	750	-1000	400	1000	mV pk
	RECOVERY <sup>3</sup>	—	200	500	—	400	1000	—	400	1000	μs
STEP LINE RESPONSE <sup>4</sup>	16 - 40 - 16 VDC TRANSIENT	-500	100	500	-800	200	800	-500	100	500	mV pk
	RECOVERY <sup>3</sup>	—	.4	1.0	—	0.5	1.3	—	0.5	1.3	ms
	OVERSHOOT	0	0	200	0	0	500	0	0	500	mV pk
START-UP	DELAY	0	10	75	0	10	30	0	10	30	ms
	INHIBIT PIN CURRENT	—	2.5	4.0	—	2.5	4.0	—	2.5	4.0	mA
CAPACITANCE	INPUT TO OUTPUT	—	50	—	—	40	—	—	60	—	pF
CAPACITIVE LOAD		—	—	300	—	—	500	—	—	500	μF

**Notes**

1. Indefinite short circuit protection not guaranteed above 125°C (case).
2. Load transient transition time is >10 μs.

3. Recovery time is measured from application of the transient to the point at which V<sub>out</sub> is within regulation.

4. Input step transition time is >10μs.

# DC/DC CONVERTERS

# MGA SERIES 5 WATT

Electrical Characteristics: 25°C Tc, 28 VDC Vin, 100% load, unless otherwise specified.

DUAL OUTPUT MODELS		MGA2805D	MGA2812D			MGA2815D			UNITS
PARAMETER	CONDITIONS		MIN	TYP	MAX	MIN	TYP	MAX	
OUTPUT VOLTAGE	+V <sub>OUT</sub>		11.88	12	12.12	14.85	15	15.15	VDC
	-V <sub>OUT</sub>		-11.76	-12	-12.24	-14.70	-15	-15.30	
OUTPUT CURRENT	V <sub>IN</sub> = 16 to 40 VDC		0	±208	333	0	±167	267	mA
OUTPUT POWER <sup>1</sup>	V <sub>IN</sub> = 16 to 40 VDC		—	—	5	—	—	5	W
OUTPUT RIPPLE <sup>2</sup>	10 kHz - 2 MHz		—	120	300	—	120	300	mV p-p
LINE REGULATION V <sub>IN</sub> = 16 to 40 VDC	+V <sub>OUT</sub>		—	10	50	—	10	50	mV
	-V <sub>OUT</sub>		—	40	180	—	40	180	
LOAD REGULATION NO LOAD TO FULL	+V <sub>OUT</sub> (BALANCED)		—	10	50	—	10	50	mV
	-V <sub>OUT</sub> (BALANCED)		—	50	200	—	50	200	
CROSS REG. <sup>3</sup>	EFFECT ON -V <sub>OUT</sub>		—	8	15	—	7	15	%
INPUT VOLTAGE	CONTINUOUS		16	28	40	16	28	40	VDC
NO LOAD TO FULL	TRANSIENT 50 ms		—	—	50	—	—	50	V
INPUT CURRENT	NO LOAD		—	33	63	—	38	63	mA
	FULL LOAD		—	—	267	—	—	263	
	INHIBITED		—	3	4	—	3	4	
INPUT RIPPLE	Tc = 25°C		—	50	200	—	50	200	mA p-p
10 kHz - 10 MHz	Tc = -55°C to +125°C		—	75	300	—	75	300	
EFFICIENCY			67	73	—	68	73	—	%
LOAD FAULT <sup>4</sup>	SHORT CIRCUIT POWER DISS.		—	1.3	1.7	—	1.3	1.6	W
	RECOVERY		—	10	30	—	10	30	ms
STEP LOAD RESPONSE <sup>5, 6</sup>	TRANSIENT		-550	180	550	-600	180	600	mV pk
	RECOVERY <sup>7</sup>		—	200	500	—	200	500	µs
STEP LINE RESPONSE <sup>8</sup>	16 - 40 - 16 VDC TRANSIENT		-500	100	500	-1500	200	1500	mV pk
	RECOVERY <sup>7</sup>		—	0.8	2.0	—	1.6	4.0	ms
START-UP	OVERSHOOT		0	200	500	0	200	500	mV pk
	DELAY		0	10	30	0	10	30	ms
INHIBIT PIN CURRENT	UNIT INHIBITED		—	2.5	4.0	—	2.5	4.0	mA
CAPACITANCE	INPUT TO OUTPUT		—	50	—	—	50	—	pF
CAPACITIVE LOAD			—	—	100	—	—	100	µF

AVAILABLE  
SOON, ASK YOUR  
INTERPOINT REP  
FOR INFORMA-  
TION

#### Notes

- Up to 4 watts, 80% of the total output power is available from either output providing the opposite output is simultaneously carrying 20% of the total output power. Each output must carry a minimum of 20% of the total output power in order to maintain regulation on the negative output.
- Applies to both +V<sub>out</sub> and -V<sub>out</sub>
- Cross regulation is specified for the following percentages of total output power: +PO = 20% and -PO = 80% to +PO = 80% and -PO = 20%
- Indefinite short circuit protection not guaranteed above 125°C (case).
- Load transient transition time is >10 µs.
- Response of either output when the load for each output is simultaneously transitioned from 25% to 50% to 25% of total output power (5 watts).
- Recovery time is measured from application of the transient to the point at which V<sub>out</sub> is within regulation.
- Input step transition time is >10µs.

CRANE

interpoint

A CRANE CO. COMPANY

# MGA SERIES 5 WATT

# DC/DC CONVERTERS

## DIAGRAMS AND CONNECTIONS

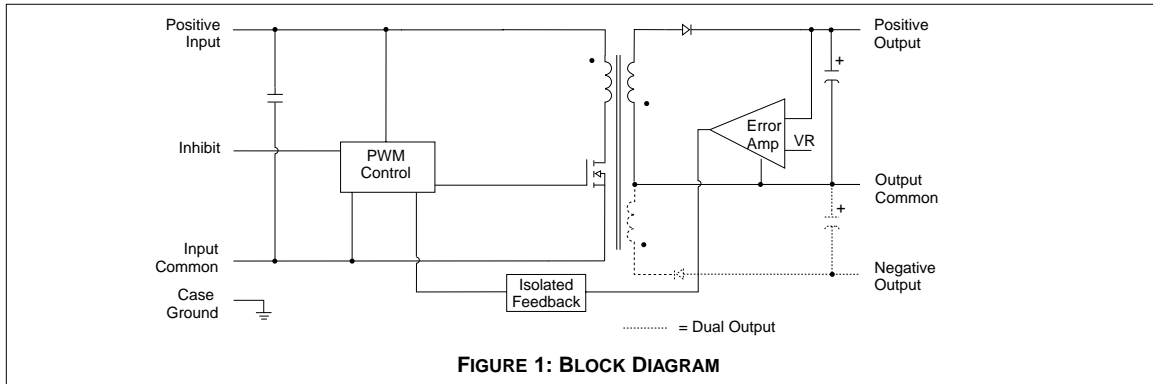

**FIGURE 2: INHIBIT INTERFACE**

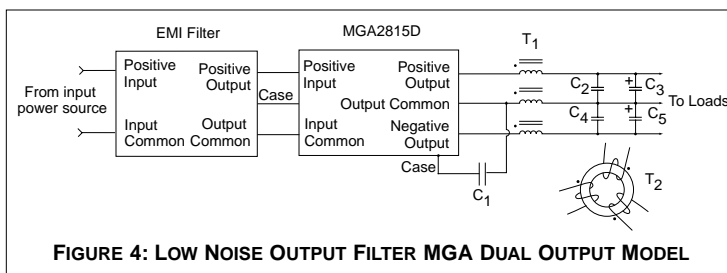
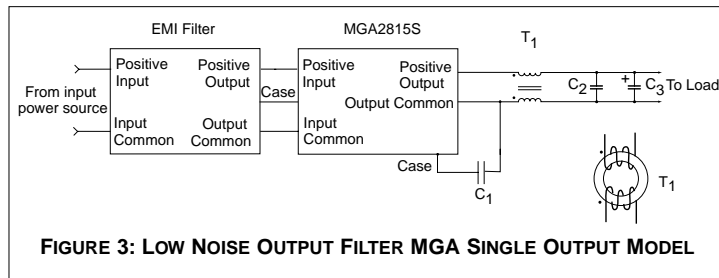
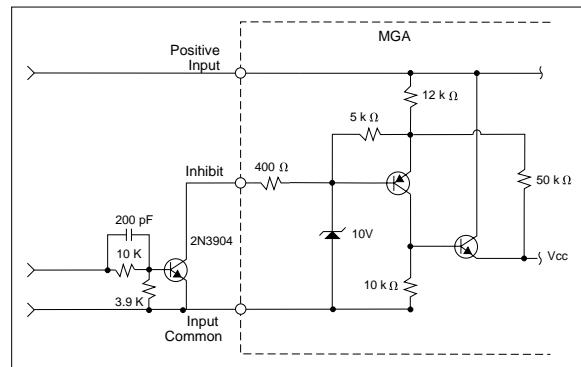

The filter suggestions in Figures 3 and 4 will further reduce the output ripple for systems requiring very low output noise.

C1 = 0.27  $\mu$ F ceramic capacitor, 500V

C2 = C4 = 6.8  $\mu$ F tantalum capacitor

C3 = C5 = 0.27  $\mu$ F ceramic capacitor

Single output: T1 = 15T #28 AWG winding on toroid,  
m = 5000

Dual output: T2 = 10T #28 AWG winding on toroid,  
m = 5000

# DC/DC CONVERTERS

# MGA SERIES 5 WATT

Pin	Single Output	Dual Output
1	Inhibit	Inhibit
2, 3	Positive Input	Positive Input
4	No connection	No connection
5, 6	Input Common	Input Common
7, 8	Case Ground	Case Ground
9, 10	No connection	No connection
11, 12	Positive Output	Positive Output
13	Positive Output	Output Common
14	Output Common	Output Common
15, 16	Output Common	Negative Output
17, 18	No connection	No connection
19, 20	Case Ground	Case Ground

**PIN OUT**

Differently colored glass bead around pin one or dimple in header (bottom of case) indicates pin one.  
Cover marking is oriented with pin one at the upper right corner.

See Section B8, case D for dimensions and gull-wing lead option.

**FIGURE 5: PIN OUT**

SMD NUMBERS	
STANDARD MICROCIRCUIT DRAWING (SMD)	MGA SERIES SIMILAR PART
5962-9309201HXC	MGA2805S/883
5962-9309301HXC	MGA2812S/883
5962-9309401HXC	MGA2815S/883
IN PROCESS	MGA2805D/883
5962-9308901HXC	MGA2812D/883
5962-9309001HXC	MGA2815D/883

Replace the "Y" with a "Z" in the SMD number to specify gull-wing leads.  
For exact specifications for an SMD product, refer to the SMD drawing.  
See Section A3, SMDs, for more information.

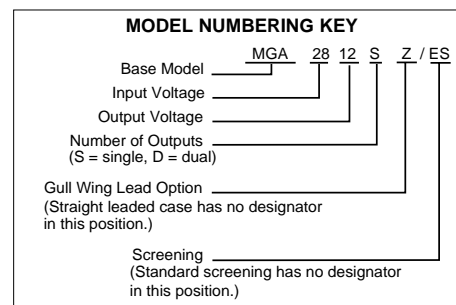

**Typical Performance Curves: 25°C Tc, 28 VDC Vin, 100% load, unless otherwise specified.**

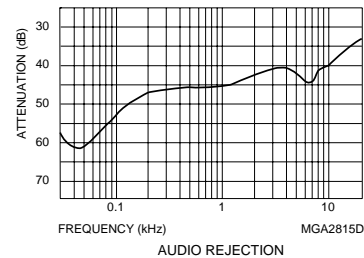
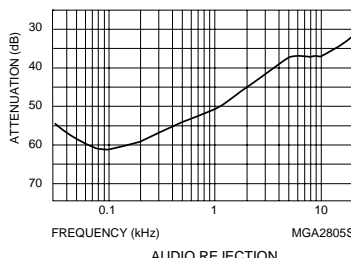
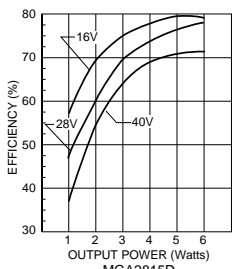
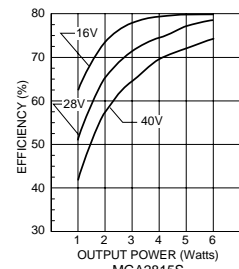
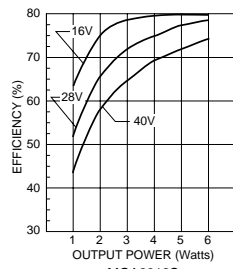
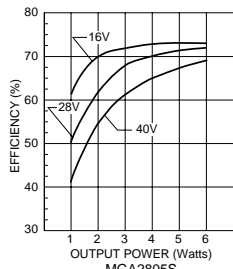

# MGA SERIES 5 WATT

# DC/DC CONVERTERS

Typical Performance Curves: 25°C Tc , 28 VDC Vin, 100% load, unless otherwise specified.

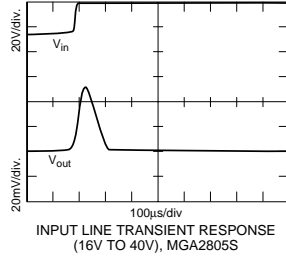

FIGURE 12

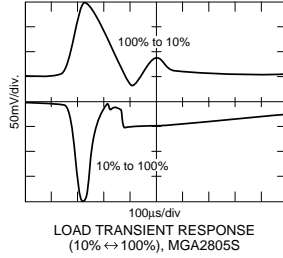

FIGURE 13

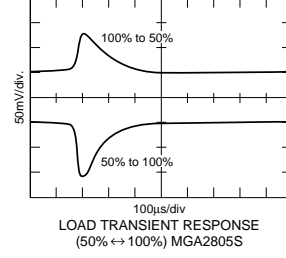

FIGURE 14

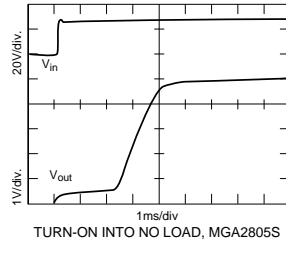

FIGURE 15

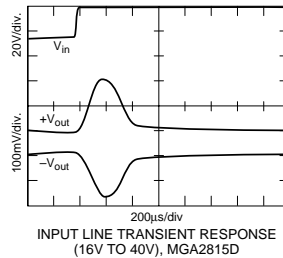

FIGURE 16

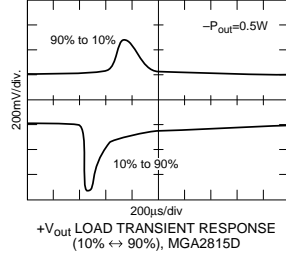

FIGURE 17

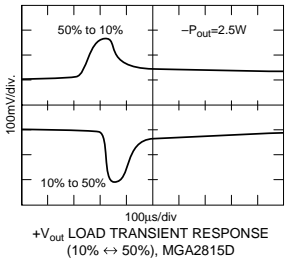

FIGURE 18

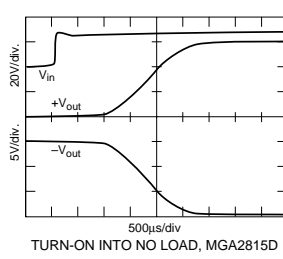

FIGURE 19

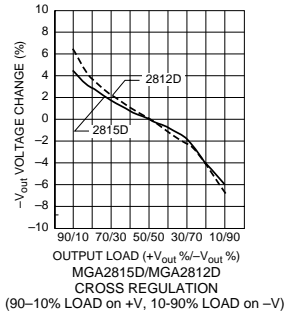

FIGURE 20

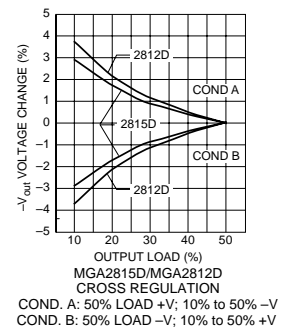
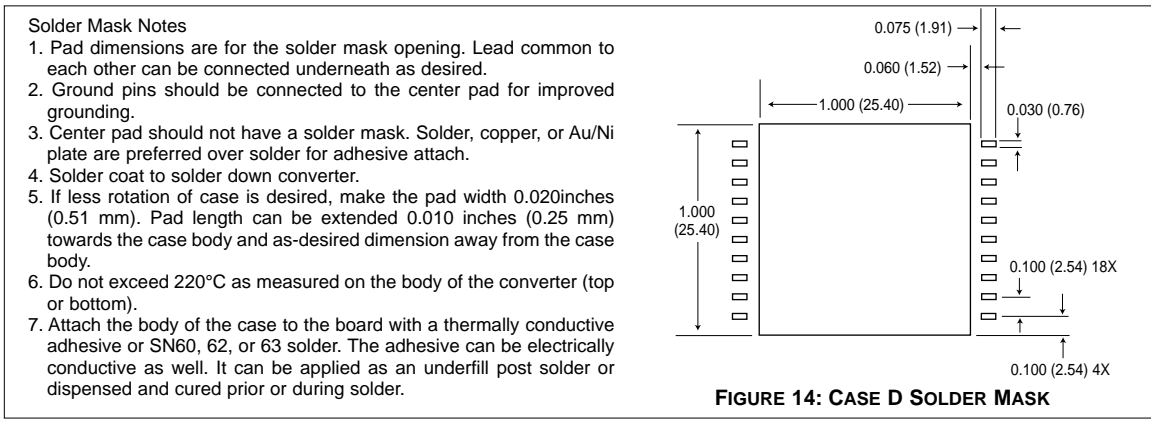
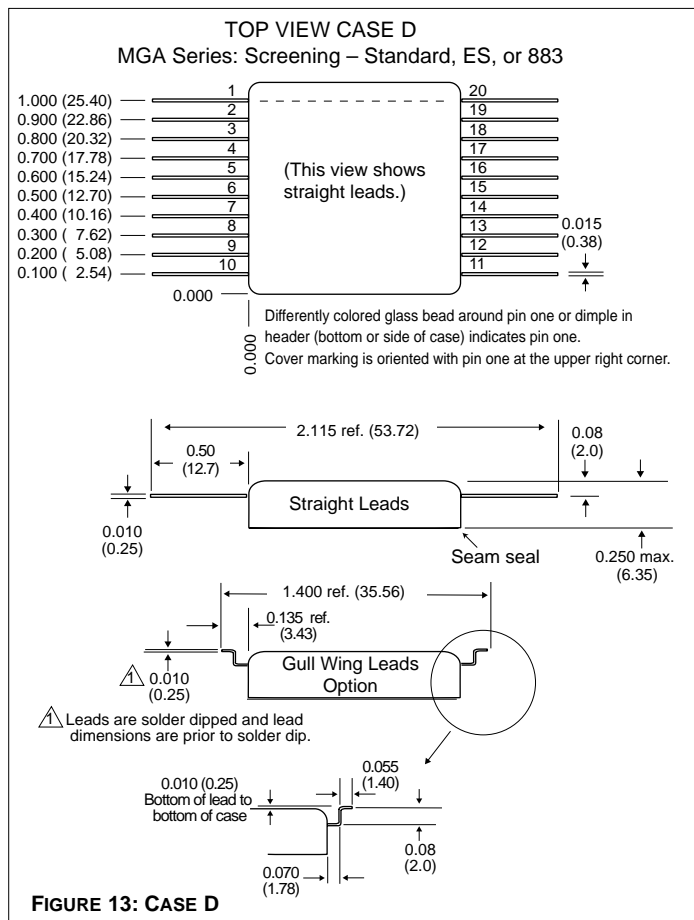
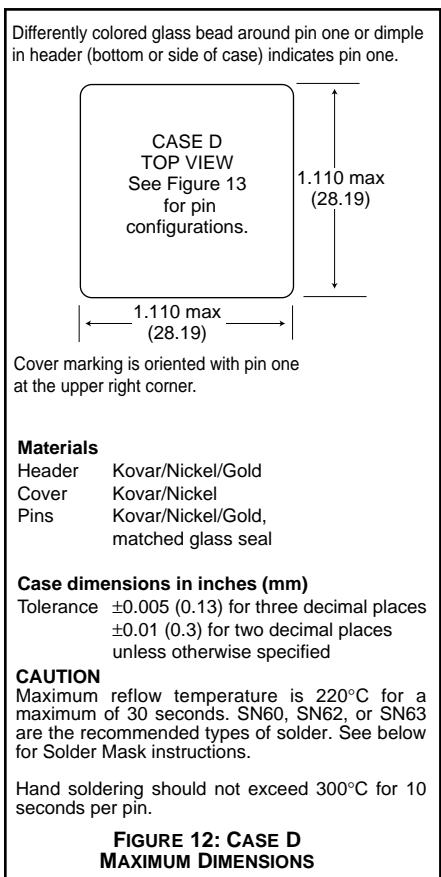

FIGURE 21

22222-001-DTS Rev A DQ# 1034  
All technical information is believed to be accurate, but no responsibility is assumed for errors or omissions. Interpoint reserves the right to make changes in products or specifications without notice. MGA Series is a trademark of Interpoint. Copyright © 1998 - 1999 Interpoint. All rights reserved.



Note: Although every effort has been made to render the case drawings at actual size, variations in the printing process may cause some distortion. Please refer to the numerical dimensions for accuracy.

# QA SCREENING 125°C PRODUCTS

## 125°C PRODUCTS

TEST (125°C Products)	STANDARD	/ES	/883 (Class H)*
PRE-CAP INSPECTION Method 2017, 2032	yes	yes	yes
TEMPERATURE CYCLE (10 times) Method 1010, Cond. C, -65°C to 150°C Method 1010, Cond. B, -55°C to 125°C	no no	no yes	yes no
CONSTANT ACCELERATION Method 2001, 3000 g Method 2001, 500 g	no no	no yes	yes no
BURN-IN Method 1015, 160 hours at 125°C 96 hours at 125°C case (typical)	no no	no yes	yes no
FINAL ELECTRICAL TEST MIL-PRF-38534, Group A Subgroups 1 through 6: -55°C, +25°C, +125°C Subgroups 1 and 4: +25°C case	no yes	no yes	yes no
HERMETICITY TESTING Fine Leak, Method 1014, Cond. A Gross Leak, Method 1014, Cond. C Gross Leak, Dip (1 x 10 <sup>-3</sup> )	no no yes	yes yes no	yes yes no
FINAL VISUAL INSPECTION Method 2009	yes	yes	yes

Test methods are referenced to MIL-STD-883 as determined by MIL-PRF-38534.

\*883 products are built with element evaluated components and are 100% tested and guaranteed over the full military temperature range of -55°C to +125°C.

Applies to the following products

MOR Series	MHD Series	MGH Series	FMGA EMI Filter
MFLHP Series	MHV Series	MCH Series	FMSA EMI Filter
MFL Series	MHF+ Series	FM-704A EMI Filter	HUM Modules**
MHP Series	MHF Series**	FMD**/FME EMI Filter	LCM Modules**
MTR Series	MGA Series	FMC EMI Filter	LIM Modules
MQO Series**	MSA Series	FMH EMI Filter	

\*\*MFLHP Series, MQO Series, MHF Series, FMD EMI Filters, Hum Modules, and LCM Modules do not offer '883' screening.