

Xinger®

Ultra Low Profile 0805 Power Divider 50Ω to 50Ω

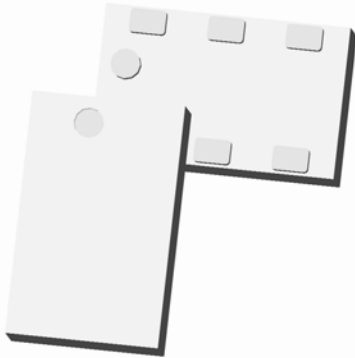

Description

The PD1722J5050S2 is a low profile, sub-miniature Wilkinson power divider in an easy to use surface mount package. The PD1722J5050S2 is ideal for high volume manufacturing and delivers higher performances than traditional printed and lumped element solutions. The PD1722J5050S2 is matched to 50 Ω and has a height profile of 0.5 mm which is ideal for high level integrations in the following markets: WCDMA, and GSM. The PD1722J5050S2 does not include the resistive element and therefore, requires an external resistor for operation. The PD1722J5050S2 is available on tape and reel for high volume manufacturing pick and place.

Detailed Electrical Specifications: Specifications subject to change without notice.

Features:	Parameter	ROOM (25°C)			Unit
		Min.	Typ.	Max	
<ul style="list-style-type: none"> • 1700-2200 MHz • 15 dB Isolation (output ports) • 0.5mm Height Profile • 50Ω Input / 50Ω Outputs • Low Insertion Loss • Surface Mountable • Tape & Reel • Non-conductive Surface • RoHS Compliant • External resistor required 	Frequency	1700		2200	MHz
	Input Port Impedance		50		Ω
	Output Port Impedance		50		Ω
	Return Loss	10	13		dB
	Insertion Loss*		0.6	0.8	dB
	Amplitude Balance		0.1	0.3	dB
	Phase Balance		1	3	Degrees
	Isolation (Output Ports)	15	18		dB
	Power Handling			2	Watts
	Operating Temperature	-55		+85	°C

* Insertion Loss stated at room temperature (Insertion Loss is approximately 0.1 dB higher at +85 °C)

Outline Drawing

Top View (Near-side)

Orientation Marker Denotes Pin Location

Side View

Bottom View (Far-side)

Orientation Marker Denotes Pin Location

Pin	Designation
1	GND
2	Input
3	GND
4	Output 1
5	GND
6	Output 2

Tolerances are Non-Cumulative

Dimensions are in Inches [Millimeters]
Mechanical Outline



Typical Broadband Performance: 500 MHz. to 6.0 GHz.

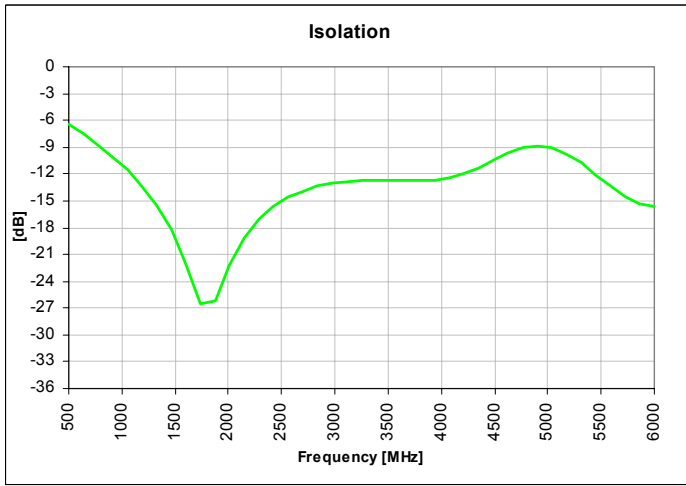
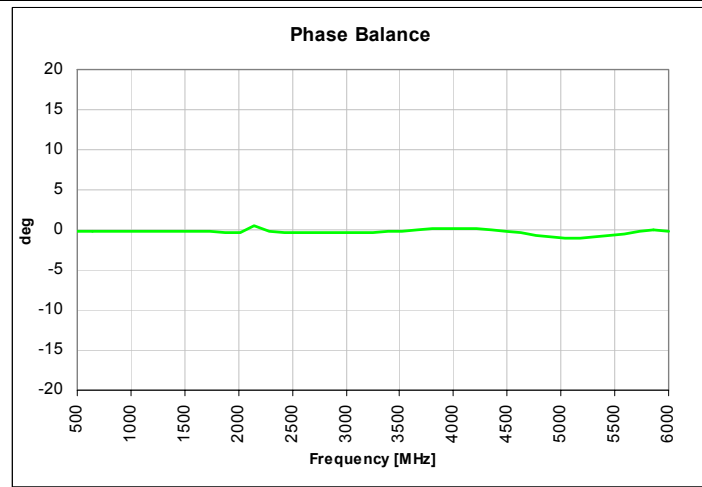
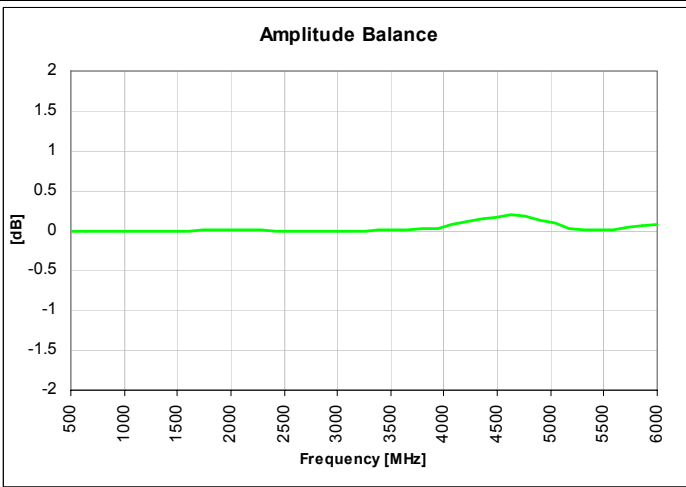
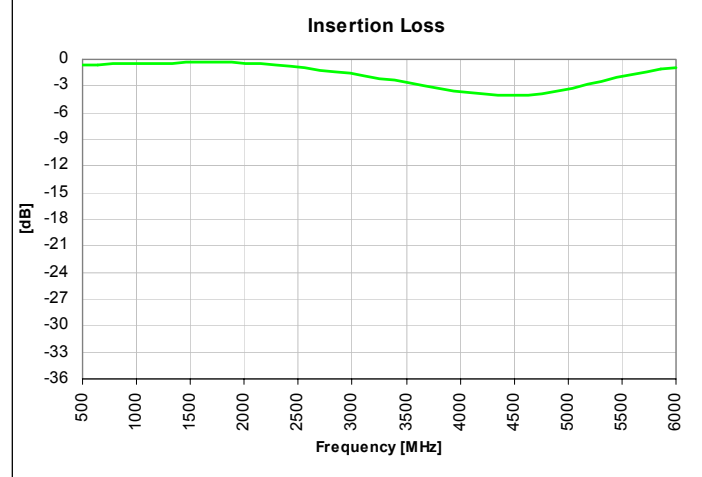
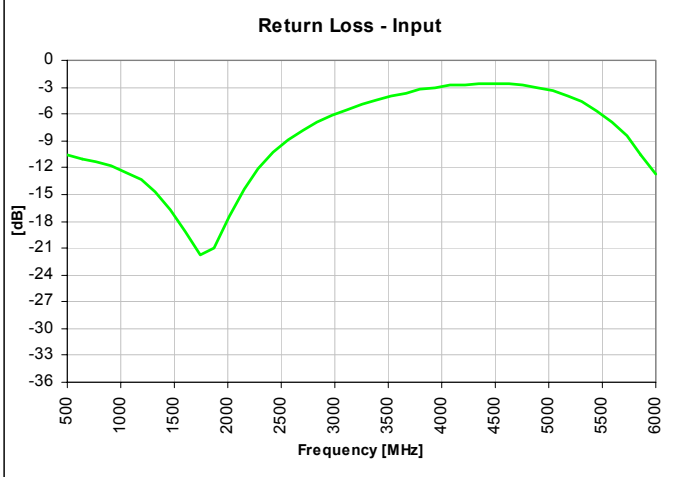

USA/Canada: (315) 432-8909
Toll Free: (800) 411-6596
Europe: +44 2392-232392

Available on Tape and Reel for Pick and Place Manufacturing.



Anaren
What'll we think of next?™

Typical Performance: 1700 MHz. to 2200 MHz.

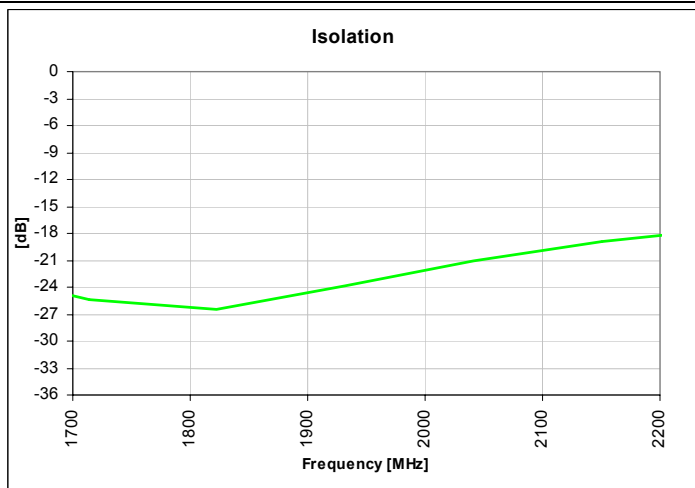
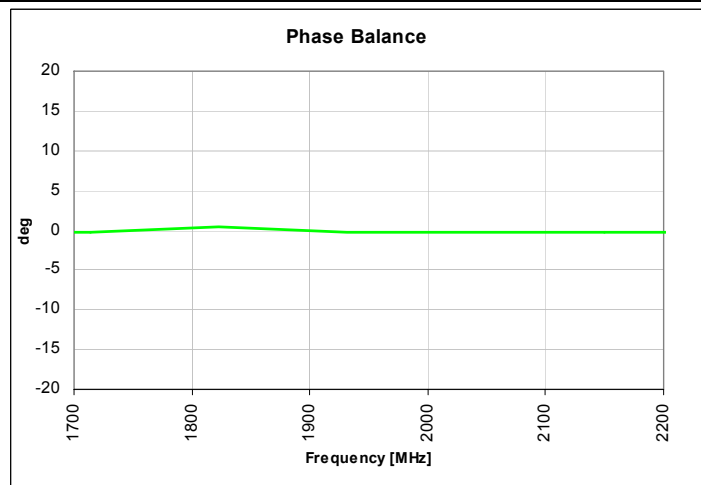
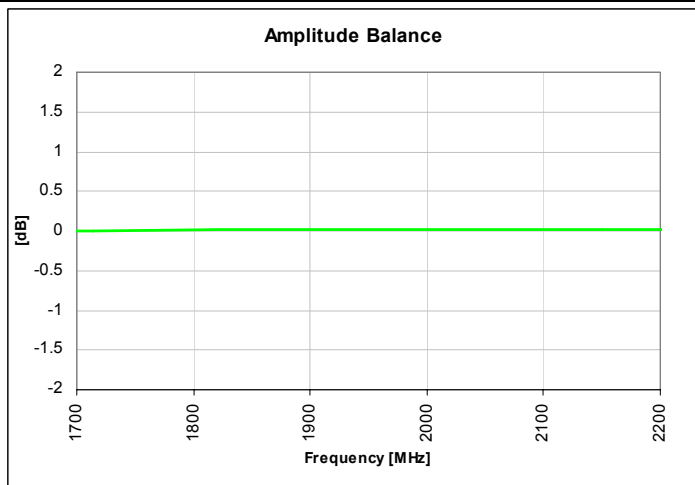
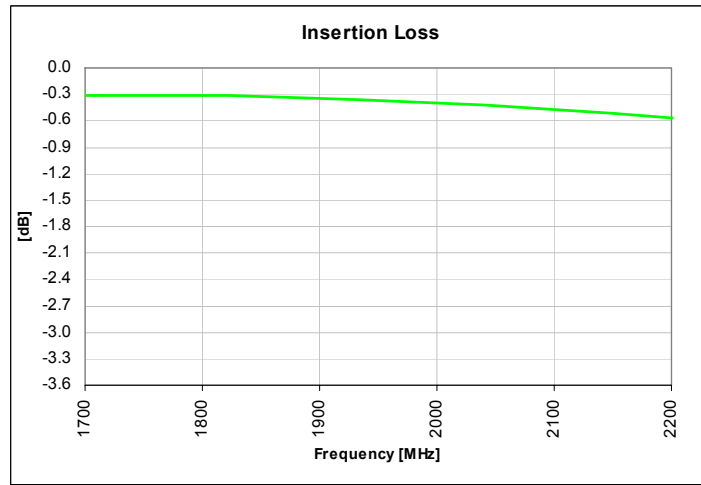
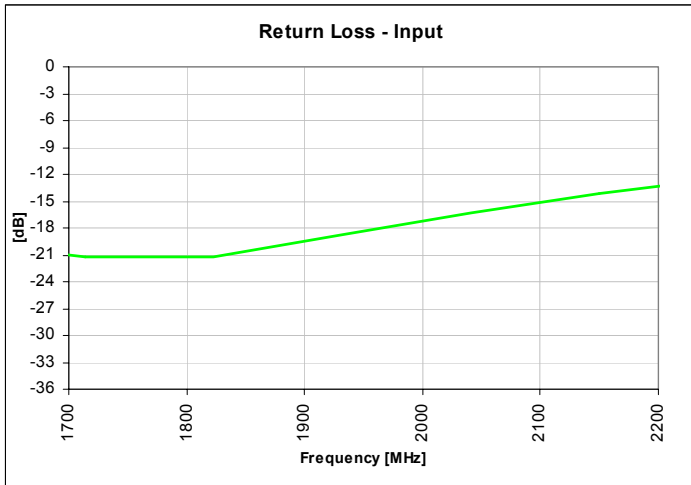

Mounting Configuration:

In order for Xinger surface mount components to work optimally, the proper impedance transmission lines must be used to connect to the RF ports. If this condition is not satisfied, insertion loss, Isolation and VSWR may not meet published specifications.

An example of the PCB footprint used in the testing of these parts is shown below. In specific designs, the transmission line widths need to be adjusted to the unique dielectric coefficients and thicknesses as well as varying pick and place equipment tolerances. In addition, since the PD1722J5050S2 is a Wilkinson power divider, an external 0603 100Ω resistor must be mounted in locations R1 as shown in the Figure below.

All of the Xinger components are constructed from ceramic filled PTFE composites which possess excellent electrical and mechanical stability having X and Y thermal coefficient of expansion (CTE) of 17 ppm/°C.

Pad Footprint w/ 0603 Resistor Locations

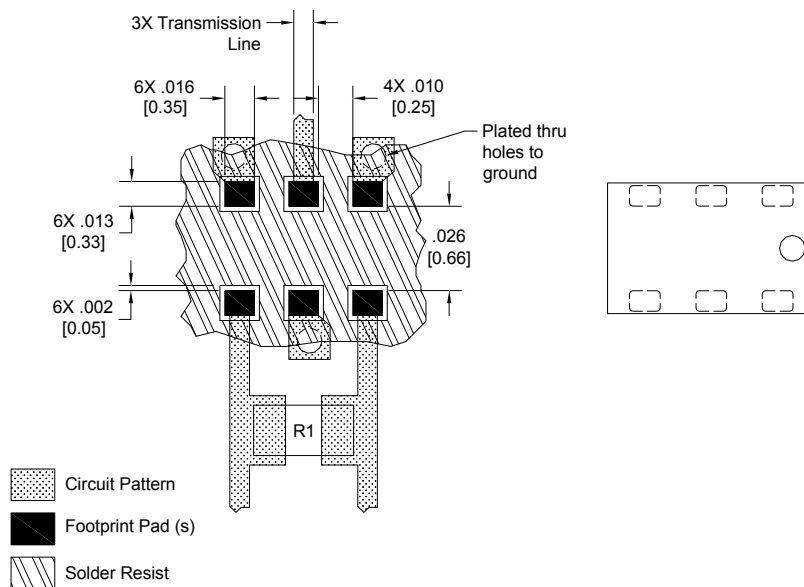

Dimensions are in Inches [Millimeters]
Mounting Footprint



Packaging and Ordering Information

Parts are available in reels and are packaged per EIA 481-2. Parts are oriented in tape and reel as shown below. Minimum order quantities are 4000 per reel. See Model Numbers below for further ordering information.

