



MIC20XX Family

Fixed and Adjustable Current Limiting Power Distribution Switches

General Description

MIC20XX family of switches are current limiting, high-side power switches, designed for general purpose power distribution and control in digital televisions (DTV), printers, set top boxes (STB), PCs, PDAs, and other peripheral devices. See Functionality Table on page 6 and Pin Configuration Drawings on page 7.

MIC20XX family's primary functions are current limiting and power switching. They are thermally protected and will shutdown should their internal temperature reach unsafe levels, protecting both the device and the load, under high current or fault conditions

Features include fault reporting, fault blanking to eliminate noise-induced false alarms, output slew rate limiting, under voltage detection, automatic-on output, and enable pin with choice of either active low or active high enable. The FET is self-contained, with a fixed or user adjustable current limit. The MIC20XX family is ideal for any system where current limiting and power control are desired.

The MIC201X ($3 \leq x \leq 9$) subfamily offers a unique new patented feature: KICKSTART™, which allows momentary high current surges up to the secondary current limit (I_{LIMIT_2nd}) without sacrificing overall system safety.

The MIC20XX family is offered, depending on the desired features, in a space saving 5-pin SOT-23, 6-pin SOT-23, and 2mm x 2mm MLF® packages.

Data sheets and support documentation can be found on Micrel's web site at www.micrel.com.

Features

- 70mΩ typical on-resistance @ 5V
- 170mΩ typical on-resistance @ 5V (MIC2005A)
- Enable active high or active low *
- 2.5V – 5.5V operating range
- Pre-set current limit values of 0.5A, 0.8A, and 1.2A *
- User adjustable current limit from 0.2A to 2.1A *
- Under voltage lock-out (UVLO)
- Variable UVLO allows adjustable UVLO thresholds *
- Automatic load discharge for capacitive loads *
- Soft start prevents large current inrush
- Adjustable slew rate allows custom slew rates *
- Automatic-on output after fault
- Thermal Protection

* Available on some family members

Applications

- Digital televisions (DTV)
- Set top boxes
- PDAs
- Printers
- USB / IEEE 1394 power distribution
- Desktop and laptop PCs
- Game consoles
- Docking stations

Typical Application

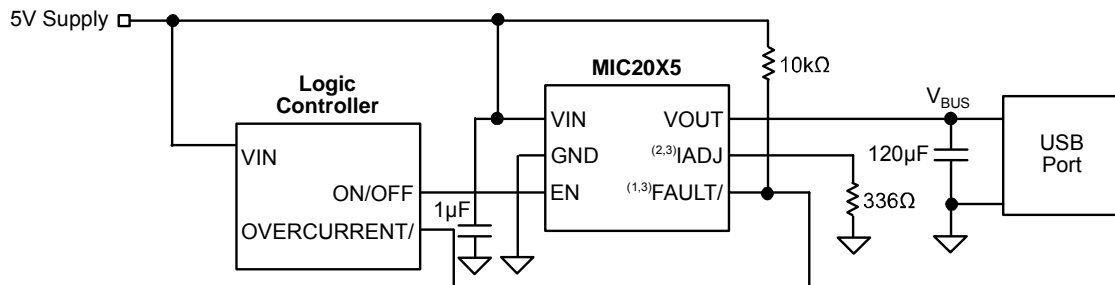

Figure 1. Typical Application Circuit

- Notes:
- (1) Depending on the family member this pin can function as FAULT/, IADJ, or VUVLO.
 - (2) Depending on the family member this pin can function as IADJ, or CSLEW.
 - (3) See Pin Configuration and Functional Diagram.

KICKSTART is a trademark of Micrel, Inc.

MLF and MicroLeadFrame are registered trademarks of Amkor Technology, Inc.

CableCARD is a trademark of CableLabs.

Protected by U.S. Patent No. 7,170,732

Micrel Inc. • 2180 Fortune Drive • San Jose, CA 95131 • USA • tel +1 (408) 944-0800 • fax +1 (408) 474-1000 • <http://www.micrel.com>

Ordering Information

MIC2003/2013

Part Number ⁽¹⁾	Marking ⁽²⁾	Current Limit	Kickstart	Package
MIC2003-0.5YM5	<u>FD</u> 05	0.5A	No	5-Pin SOT-23
MIC2003-0.8YM5	<u>FD</u> 08	0.8A		
MIC2003-1.2YM5	<u>FD</u> 12	1.2A		
MIC2003-0.5YML	<u>D</u> 05	0.5A		6-Pin 2mm x 2mm MLF [®]
MIC2003-0.8YML	<u>D</u> 08	0.8A		
MIC2003-1.2YML	<u>D</u> 12	1.2A		
MIC2013-0.5YM5	<u>FL</u> 05	0.5A	Yes	5-Pin SOT-23
MIC2013-0.8YM5	<u>FL</u> 08	0.8A		
MIC2013-1.2YM5	<u>FL</u> 12	1.2A		
MIC2013-0.5YML	<u>L</u> 05	0.5A		6-Pin 2mm x 2mm MLF [®]
MIC2013-0.8YML	<u>L</u> 09	0.8A		
MIC2013-1.2YML	<u>L</u> 12	1.2A		

MIC2004/2014

Part Number ⁽¹⁾	Marking ⁽²⁾	Current Limit	Kickstart	Package
MIC2004-0.5YM5	<u>FE</u> 05	0.5A	No	5-Pin SOT-23
MIC2004-0.8YM5	<u>FE</u> 08	0.8A		
MIC2004-1.2YM5	<u>FE</u> 12	1.2A		
MIC2004-0.5YML	<u>E</u> 05	0.5A		6-Pin 2mm x 2mm MLF [®]
MIC2004-0.8YML	<u>E</u> 08	0.8A		
MIC2004-1.2YML	<u>E</u> 12	1.2A		
MIC2014-0.5YM5	<u>FM</u> 05	0.5A	Yes	5-Pin SOT-23
MIC2014-0.8YM5	<u>FM</u> 08	0.8A		
MIC2014-1.2YM5	<u>FM</u> 12	1.2A		
MIC2014-0.5YML	<u>M</u> 05	0.5A		6-Pin 2mm x 2mm MLF [®]
MIC2014-0.8YML	<u>M</u> 09	0.8A		
MIC2014-1.2YML	<u>M</u> 12	1.2A		

- Notes:**
1. All MIC20XX Family parts are RoHS compliant lead free.
 2. Over/Under-bar symbol (/) may not be to scale. On the package the over/under symbol begins above/below the first character of the marking.

Ordering Information (continued)

MIC2005

Part Number ⁽¹⁾	Marking ⁽²⁾	Current Limit	Enable	Kickstart	Package
MIC2005-0.5YM6	<u>FF</u> 05	0.5A	Active High	No	6-Pin SOT-23
MIC2005-0.8YM6	<u>FF</u> 08	0.8A	Active High		
MIC2005-1.2YM6	<u>FF</u> 12	1.2A	Active High		
MIC2005-0.5YML	<u>F</u> 05	0.5A	Active High		6-Pin 2mm x 2mm MLF [®]
MIC2005-0.8YML	<u>F</u> 08	0.8A	Active High		
MIC2005-1.2YML	<u>F</u> 12	1.2A	Active High		

MIC2005L

Part Number ⁽¹⁾	Marking ⁽²⁾	Current Limit	Enable	Kickstart	Package
MIC2005-0.5LYM5	<u>5L</u> FF	0.5A	Active Low	No	5-Pin SOT-23
MIC2005-0.8LYM5	<u>8L</u> FF	0.8A	Active Low		
MIC2005-1.2LYM5	<u>4L</u> FF	1.2A	Active Low		

MIC2005A

Part Number ⁽¹⁾	Marking ⁽²⁾	Current Limit	Enable	Kickstart	Package
MIC2005A-1YM5	<u>FA</u> 51	0.5A	Active High	No	5-Pin SOT-23
MIC2005A-2YM5	<u>FA</u> 52	0.5A	Active Low		
MIC2005A-1YM6	<u>FA</u> 53	0.5A	Active High		6-Pin SOT-23
MIC2005A-2YM6	<u>FA</u> 54	0.5A	Active Low		

MIC2015

Part Number ⁽¹⁾	Marking ⁽²⁾	Current Limit	Enable	Kickstart	Package
MIC2015-0.5YM6	<u>FN</u> 05	0.5A	Active High	Yes	6-Pin SOT-23
MIC2015-0.8YM6	<u>FN</u> 08	0.8A	Active High		
MIC2015-1.2YM6	<u>FN</u> 12	1.2A	Active High		
MIC2015-0.5YML	<u>N</u> 05	0.5A	Active High		6-Pin 2mm x 2mm MLF [®]
MIC2015-0.8YML	<u>N</u> 08	0.8A	Active High		
MIC2015-1.2YML	<u>N</u> 12	1.2A	Active High		

- Notes:**
- All MIC20XX Family parts are RoHS compliant lead free.
 - Over/Under-bar symbol (/) may not be to scale. On the package the over/under symbol begins above/below the first character of the marking.

Ordering Information (continued)

MIC2006/2016

Part Number ⁽¹⁾	Marking ⁽²⁾	Current Limit	Kickstart	Package
MIC2006-0.5YM6	<u>FG</u> 05	0.5A	No	6-Pin SOT-23
MIC2006-0.8YM6	<u>FG</u> 08	0.8A		
MIC2006-1.2YM6	<u>FG</u> 12	1.2A		
MIC2006-0.5YML	<u>G</u> 05	0.5A		6-Pin 2mm x 2mm MLF [®]
MIC2006-0.8YML	<u>G</u> 08	0.8A		
MIC2006-1.2YML	<u>G</u> 12	1.2A		
MIC2016-0.5YM6	<u>FP</u> 05	0.5A	Yes	6-Pin SOT-23
MIC2016-0.8YM6	<u>FP</u> 08	0.8A		
MIC2016-1.2YM6	<u>FP</u> 12	1.2A		
MIC2016-0.5YML	<u>P</u> 05	0.5A		6-Pin 2mm x 2mm MLF [®]
MIC2016-0.8YML	<u>P</u> 09	0.8A		
MIC2016-1.2YML	<u>P</u> 12	1.2A		

- Notes:**
- All MIC20XX Family parts are RoHS compliant lead free.
 - Over/Under-bar symbol (/) may not be to scale. On the package the over/under symbol begins above/below the first character of the marking.

Ordering Information (continued)

MIC2007/2017

Part Number ⁽¹⁾	Marking ⁽²⁾	Current Limit	Kickstart	Package
MIC2007YM6	<u>F</u> HAA	0.2A – 2.0A	No	6-Pin SOT-23
MIC2007YML	<u>H</u> AA			6-Pin 2mm x 2mm MLF [®]
MIC2017YM6	<u>F</u> QAA		Yes	6-Pin SOT-23
MIC2017YML	<u>Q</u> AA			6-Pin 2mm x 2mm MLF [®]

MIC2008/2018

Part Number ⁽¹⁾	Marking ⁽²⁾	Current Limit	Kickstart	Package
MIC2008YM6	<u>F</u> JAA	0.2A – 2.0A	No	6-Pin SOT-23
MIC2008YML	<u>J</u> AA			6-Pin 2mm x 2mm MLF [®]
MIC2018YM6	<u>F</u> RAA		Yes	6-Pin SOT-23
MIC2018YML	<u>R</u> AA			6-Pin 2mm x 2mm MLF [®]

MIC2009/2019

Part Number ⁽¹⁾	Marking ⁽²⁾	Current Limit	Kickstart	Package
MIC2009YM6	<u>F</u> KAA	0.2A – 2.0A	No	6-Pin SOT-23
MIC2009YML	<u>K</u> AA			6-Pin 2mm x 2mm MLF [®]
MIC2019YM6	<u>F</u> SAA		Yes	6-Pin SOT-23
MIC2019YML	<u>S</u> AA			6-Pin 2mm x 2mm MLF [®]

- Notes:**
1. All MIC20XX Family parts are RoHS compliant lead free.
 2. Over/Under-bar symbol (/) may not be to scale. On the package the over/under symbol begins above/below the first character of the marking.

MIC20XX Family Member Functionality

Part Number		I Limit	Pin Function						
Normal Limiting	Kickstart ⁽¹⁾		ILIMIT	ENABLE High	ENABLE Low	CSLEW	FAULT/	VUVLO ⁽⁵⁾	Load Discharge
2003	2013	Fixed ⁽³⁾	—	—	—	—	—	—	—
2004	2014		—	▲	—	—	—	—	▲
2005	2015		—	▲	—	▲	▲	—	—
2005L	— ⁽²⁾		—	—	▲	— ⁽⁶⁾	▲	—	—
2005A-1	— ⁽²⁾		—	▲	—	▲ ⁽⁶⁾	▲	—	—
2005A-2	— ⁽²⁾		—	—	▲	▲ ⁽⁶⁾	▲	—	—
2006	2016		—	▲	—	▲	—	▲	—
2007	2017	Adj. ⁽⁴⁾	▲	▲	—	▲	—	—	▲
2008	2018		▲	▲	—	▲	—	—	—
2009	2019		▲	▲	—	—	▲	—	—

- Notes:**
1. Kickstart provides an alternate start-up behavior; however, pin-outs are identical.
 2. Kickstart not available.
 3. Fixed = Factory programmed current limit.
 4. Adj. = User adjustable current limit.
 5. VUVLO = Variable UVLO (Previously called DML).
 6. CSLEW not available in 5-pin package.

MIC20XX Family Member Pin Configuration Table

Part Number		I Limit	Pin Number					
Normal Limiting	Kickstart		1	2	3	4	5	6
2003	2013	Fixed ⁽²⁾	VIN	GND	—	—	—	VOUT
2004	2014		VIN	GND	EN	—	—	VOUT
2005	2015		VIN	GND	EN	FAULT/	CSLEW	VOUT
2005L	— ⁽¹⁾		VIN	GND	EN	FAULT/	CSLEW ⁽⁵⁾	VOUT
2005A	— ⁽¹⁾		VIN	GND	EN	FAULT/	CSLEW ⁽⁵⁾	VOUT
2006	2016		VIN	GND	EN	VUVLO ⁽⁴⁾	CSLEW	VOUT
2007	2017	Adj. ⁽³⁾	VIN	GND	EN	IADJ	CSLEW	VOUT
2008	2018		VIN	GND	EN	IADJ	CSLEW	VOUT
2009	2019		VIN	GND	EN	FAULT/	IADJ	VOUT

- Notes:**
1. Kickstart not available.
 2. Fixed = Factory programmed current limit.
 3. Adj. = User adjustable current limit.
 4. VUVLO = Variable UVLO (Previously called DLM).
 5. CSLEW not available in 5-pin package.

MIC20XX Family Member Pin Configuration Drawings

Fixed Current Limit

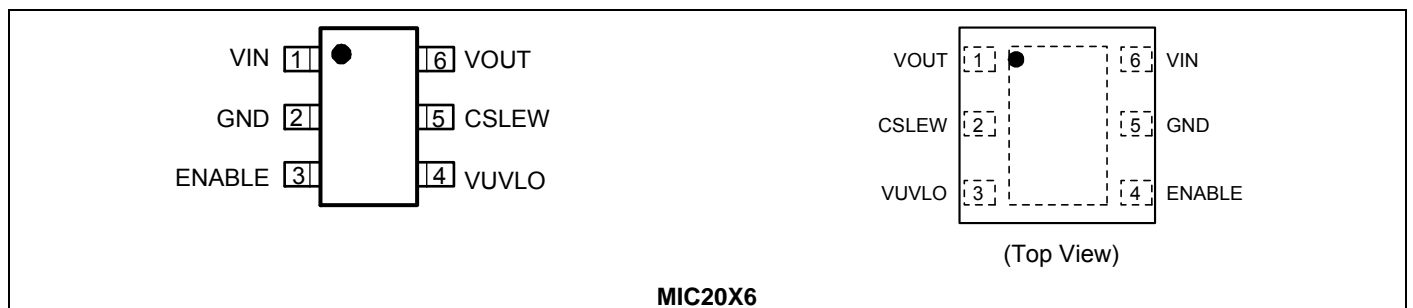
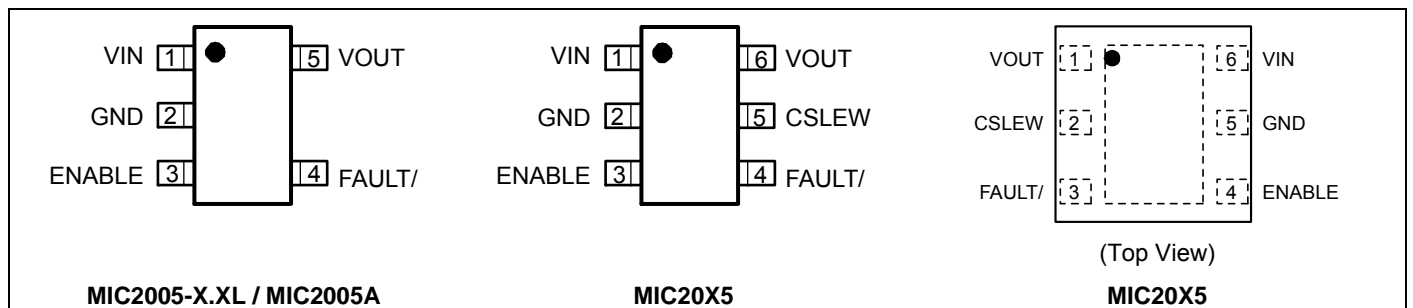
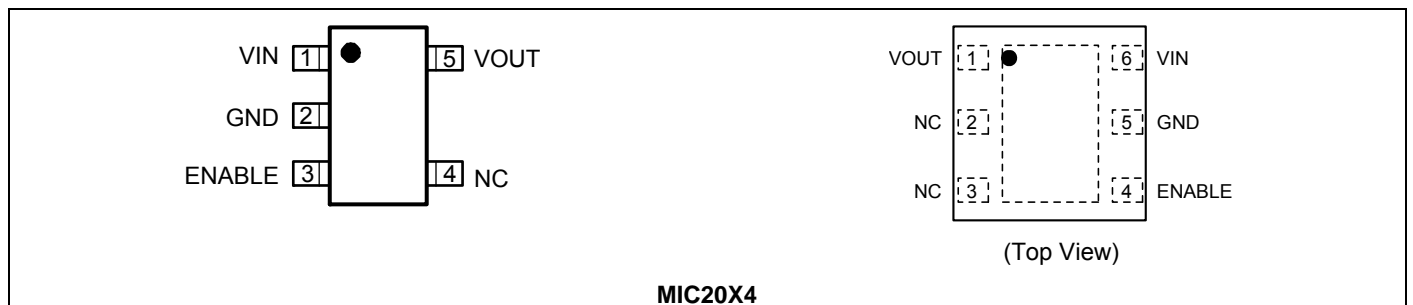
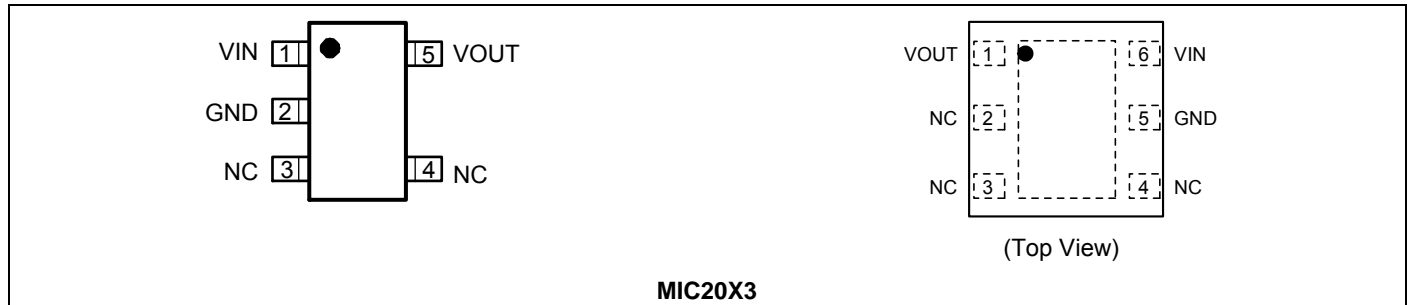

MIC20XX Family Member Pin Configuration Drawings (continued)

Adjustable Current Limit

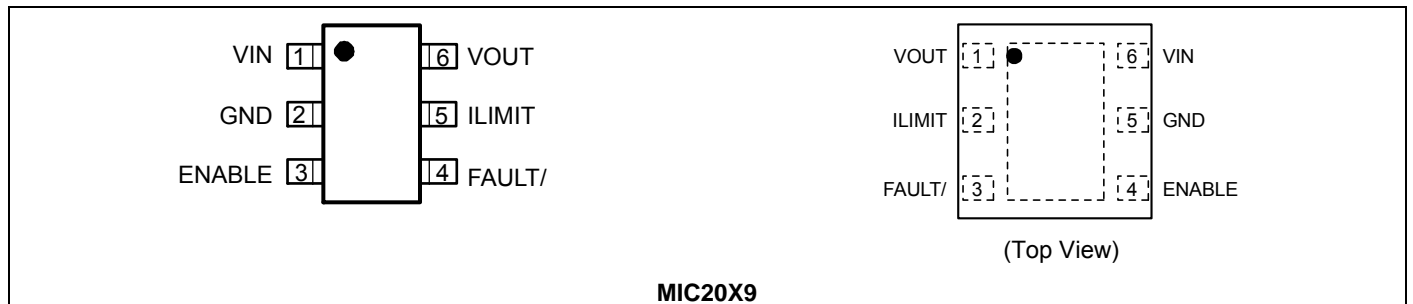
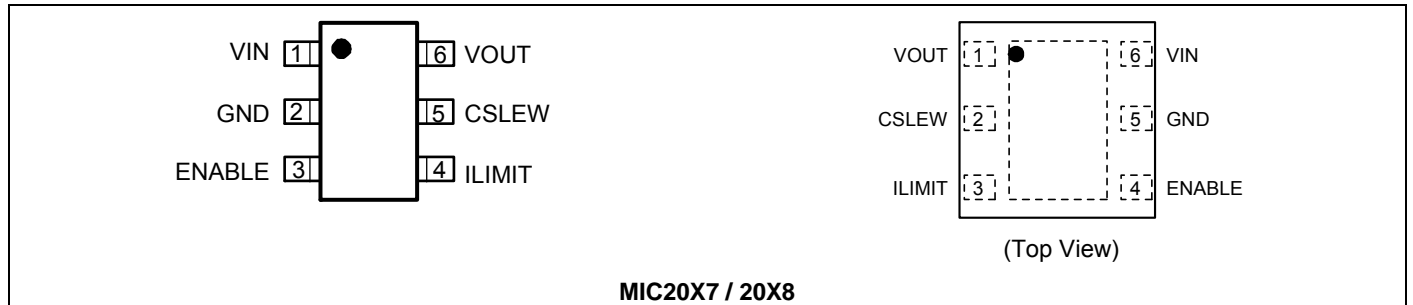

Descriptions

These pin and signal descriptions aid in the differentiation of a pin from electrical signals and components connected to that pin. For example, VOUT is the switch's output pin, while V_{OUT} is the electrical signal output voltage present at the VOUT pin.

Pin Descriptions

Pin Name	Type	Description
VIN	Input	Supply input. This pin provides power to both the output switch and the switch's internal control circuitry.
GND	—	Ground.
ENABLE	Input	Switch Enable (Input):
FAULT/	Output	Fault status. A logic LOW on this pin indicates the switch is in current limiting, or has been shut down by the thermal protection circuit. This is an open-drain output allowing logical OR'ing of multiple switches.
CSLEW	Input	Slew rate control. Adding a small value capacitor between this pin and VIN slows turn-ON of the power FET.
VOUT	Output	Switch output. The load being driven by the switch is connected to this pin.
VUVLO	Input	Variable Under Voltage Lockout (VUVLO): Monitors the input voltage through a resistor divider between VIN and GND. Shuts the switch off if voltage falls below the threshold set by the resistor divider. Previously called VUVLO.
ILIMIT	Input	Set current limit threshold via a resistor connected from ILIMIT to GND.

Signal Descriptions

Signal Name	Type	Description
V_{IN}	Input	Electrical signal input voltage present at the VIN pin.
GND	—	Ground.
V_{EN}	Input	Electrical signal input voltage present at the ENABLE pin.
$V_{FAULT/}$	Output	Electrical signal output voltage present at the FAULT/ pin.
CSLEW	Component	Capacitance value connected to the CSLEW pin.
V_{OUT}	Output	Electrical signal output voltage present at the VOUT pin.
V_{VUVLO_TH}	Internal	VUVLO internal reference threshold voltage. This voltage is compared to the VUVLO pin input voltage to determine if the switch should be disabled. Reference threshold voltage has a typical value of 250mV.
CLOAD	Component	Capacitance value connected in parallel with the load. Load capacitance.
I_{OUT}	Output	Electrical signal output current present at the VOUT pin.
I_{LIMIT}	Internal	Switch's current limit. Fixed at factory or user adjustable.

Absolute Maximum Ratings⁽¹⁾

V _{IN} , V _{OUT}	-0.3V to 6V
All other pins.....	-0.3V to 5.5V
Power Dissipation (P _D).....	Internally Limited
Continuous Output Current.....	2.25A
Continuous Output Current (MIC2005A).....	0.9A
Maximum Junction Temperature (T _J).....	150°C
Storage Temperature (T _s).....	-65°C to +150°C

Operating Ratings⁽²⁾

Supply Voltage.....	2.5V to 5.5V
Continuous Output Current Range.....	0A to 2.1A
Ambient Temperature Range (T _A).....	-40°C to +85°C
Package Thermal Resistance ⁽³⁾	
SOT-23-5/6 (θ _{JA}).....	230°C/W
2mm x 2mm MLF-6 (θ _{JA}).....	90°C/W
2mm x 2mm MLF-6 (θ _{JC}).....	45°C/W

Electrical Characteristics⁽⁴⁾

V_{IN} = 5V, T_A = 25°C unless otherwise specified. **Bold** indicates -40°C to +85°C limits; C_{IN} = 1μF.

Symbol	Parameter	Condition	Min	Typ	Max	Units	
V _{IN}	Switch Input Voltage		2.5		5.5	V	
I _{IN}	Internal Supply Current All except: MIC2005-X.XLYM5 MIC2005A	Switch = OFF V _{EN} = 0V		1	5	μA	
		Switch = ON, I _{OUT} = 0A V _{EN} = 1.5V		80	330	μA	
	Internal Supply Current MIC2005-X.XLYM5	Switch = OFF V _{EN} = 1.5V		8	15	μA	
		Switch = ON, I _{OUT} = 0A V _{EN} = 0V		80	300	μA	
	Internal Supply Current MIC2005A	Switch = OFF MIC2005A-1, V _{EN} = 0V			1	5	μA
		Switch = OFF MIC2005A-2, V _{EN} = 1.5V			8	15	μA
Switch = ON MIC2005A-1, V _{EN} = 1.5V MIC2005A-2, V _{EN} = 0V				80	300	μA	
I _{LEAK}	Output Leakage Current	Switch = OFF, V _{OUT} = 0V Active Low; ENABLE = 1.5V Active High; ENABLE = 0V		12	100	μA	
I _{EN}	Enable Input Current	0V ≤ V _{EN} ≤ 5V		1	5	μA	
I _{CSLEW}	C _{SLEW} Input Current	0V ≤ V _{OUT} ≤ 0.8V _{IN}		0.175		μA	
R _{DS(ON)}	Power Switch Resistance All except MIC2005A	V _{IN} = 5V, I _{OUT} = 100mA		70	100	mΩ	
					125		
	Power Switch Resistance Only MIC2005A	V _{IN} = 5V, I _{OUT} = 100mA		170	220		
					275		
R _{DSCHG}	Load Discharge Resistance MIC20X4 & MIC20X7	V _{IN} = 5V, I _{SINK} = 5mA	70	126	200	Ω	
I _{LIMIT}	Fixed Current Limit MIC20X3 – MIC20X6	MIC20XX-0.5, V _{OUT} = 0.8 * V _{IN}	0.5	0.7	0.9	A	
		MIC20XX-0.8, V _{OUT} = 0.8 * V _{IN}	0.8	1.1	1.5		
		MIC20XX-1.2, V _{OUT} = 0.8 * V _{IN}	1.2	1.6	2.1		

Electrical Characteristics (continued)

Symbol	Parameter	Condition	Min	Typ	Max	Units
C _{LF}	Variable Current Limit Factor MIC20X7 – MIC20X9 $R_{SET} (\Omega) = \frac{CLF (V)}{I_{OUT} (A)}$	I _{OUT} = 2A, V _{OUT} = 0.8V _{IN}	210	250	286	V
		I _{OUT} = 1A, V _{OUT} = 0.8V _{IN}	190	243	293	
		I _{OUT} = 0.5A, V _{OUT} = 0.8V _{IN}	168	235	298	
		I _{OUT} = 0.2A, V _{OUT} = 0.8V _{IN}	144	225	299	
I _{LIMIT_2nd}	Secondary current limit MIC201X (All Kickstart parts only)	V _{IN} = 2.5V	2.2	4	6	A
UVLO _{THRESHOLD}	Under Voltage Lock Out Threshold	V _{IN} Rising	2	2.25	2.5	V
		V _{IN} Falling	1.9	2.15	2.4	
UVLO _{Hysteresis}	Undervoltage Lock Out Hysteresis			0.1		V
V _{VUVLO_TH}	Variable UVLO Threshold MIC20X6		225	250	275	mV
V _{EN}	ENABLE Input Voltage ⁽⁵⁾	V _{IL (MAX)}			0.5	V
		V _{IH (MIN)}	1.5			
V _{FAULT}	Fault status Output Voltage	I _{OL} = 10mA		0.25	0.4	V
OT _{THRESHOLD}	Over-temperature Threshold	T _J Increasing		145		°C
		T _J Decreasing		135		

AC Characteristics

Symbol	Parameter	Condition	Min	Typ	Max	Units
t _{RISE}	Output Turn-on rise time	R _L = 10 Ω, C _{LOAD} = 1μF, V _{OUT} = 10% to 90% *CSLEW = Open	500	1000	1500	μs
t _{D_FAULT}	Delay before asserting or releasing FAULT/ MIC200X	Time from current limiting to FAULT/ state change	20	32	49	ms
	Delay before asserting or releasing FAULT/ MIC201X	Time from I _{OUT} continuously exceeding primary current limit condition to FAULT/ state change	77	128	192	
t _{D_LIMIT}	Delay before current limiting MIC201X		77	128	192	ms
t _{RESET}	Delay before resetting Kickstart current limit delay, t _{D_LIMIT} MIC201X	Out of current limit following a current limit event.	77	128	192	ms
t _{ON_DLY}	Output Turn-on Delay	R _L = 43Ω, C _L = 120μF, V _{EN} = 50% to V _{OUT} = 10% *CSLEW = Open		1000	1500	μs
t _{OFF_DLY}	Output Turn-off Delay	R _L = 43Ω, C _L = 120μF, V _{EN} = 50% to V _{OUT} = 90% *CSLEW = Open			700	μs

Note: * Whenever CSLEW is present.

Electrical Characteristics (continued)

ESD⁽⁶⁾

Symbol	Parameter	Condition	Min	Typ	Max	Units
V _{ESD_HB}	Electro Static Discharge Voltage: Human Body Model	V _{OUT} and GND	±4			kV
		All other pins	±2			
V _{ESD_MCHN}	Electro Static Discharge Voltage; Machine Model	All pins Machine Model	±200			V

Notes:

1. Exceeding the absolute maximum rating may damage the device.
2. The device is not guaranteed to function outside its operating rating.
3. Requires proper thermal mounting to achieve this performance
4. Specifications for packaged product only.
5. V_{IL(MAX)} = maximum positive voltage applied to the input which will be accepted by the device as a logic low.
V_{IH(MIN)} = minimum positive voltage applied to the input which will be accepted by the device as a logic high.
6. Devices are ESD sensitive. Handling precautions recommended. Human body model, 1.5k in series with 100pF.

Timing Diagrams

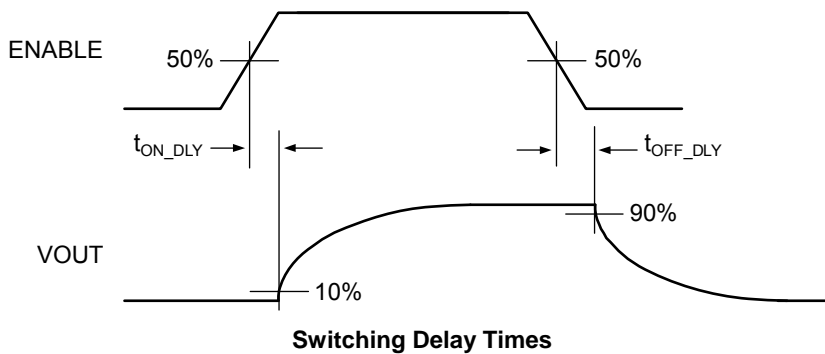
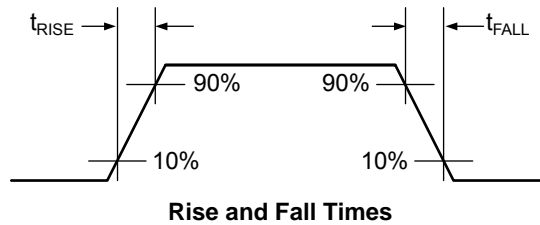

Typical Characteristics

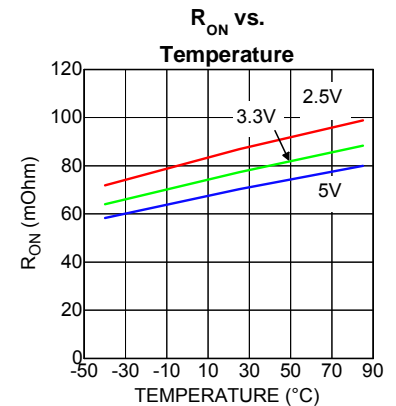
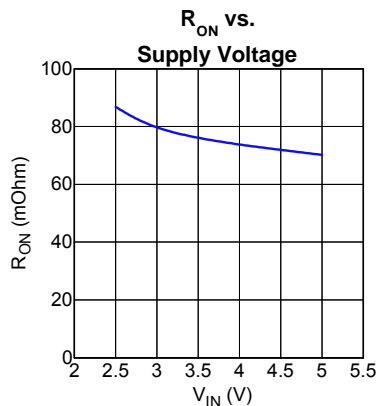
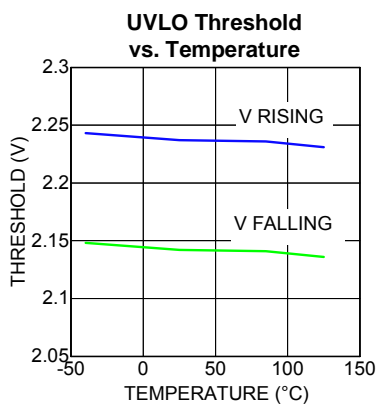
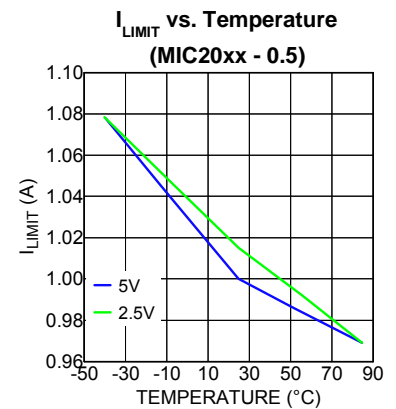
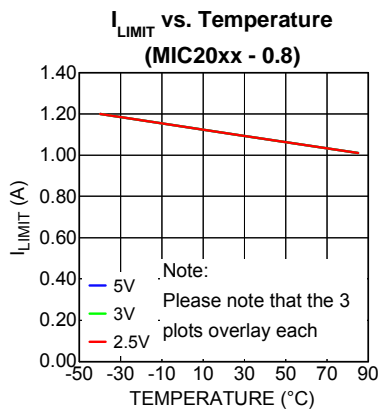
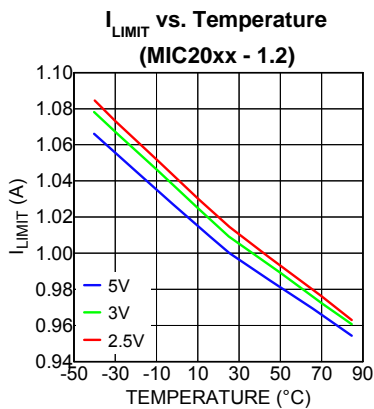
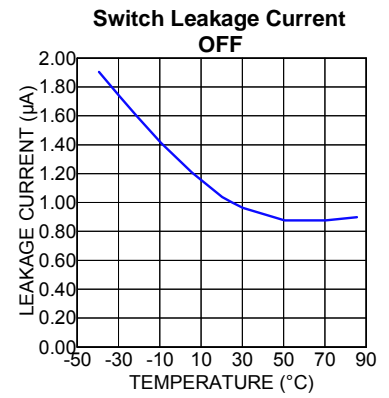
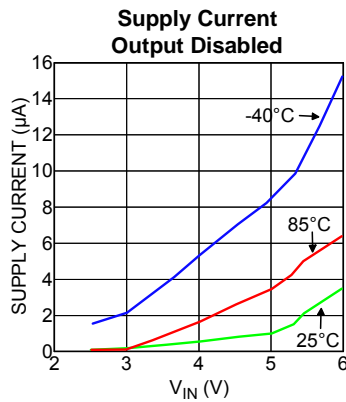
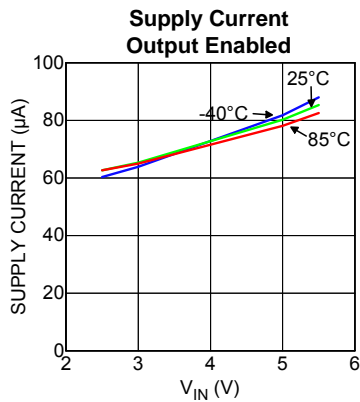

Functional Characteristics

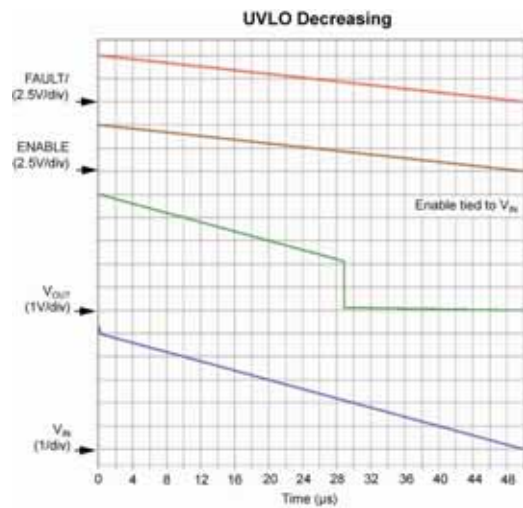
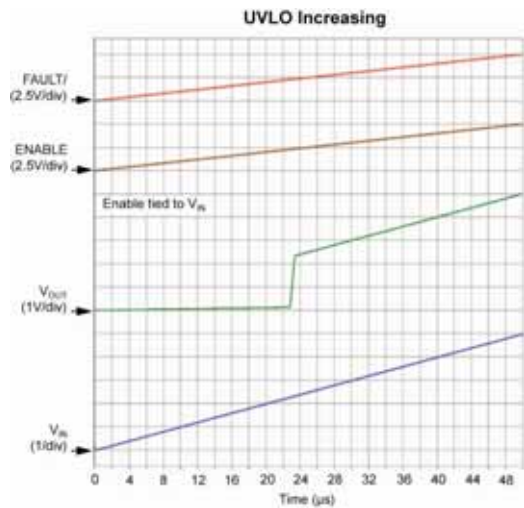
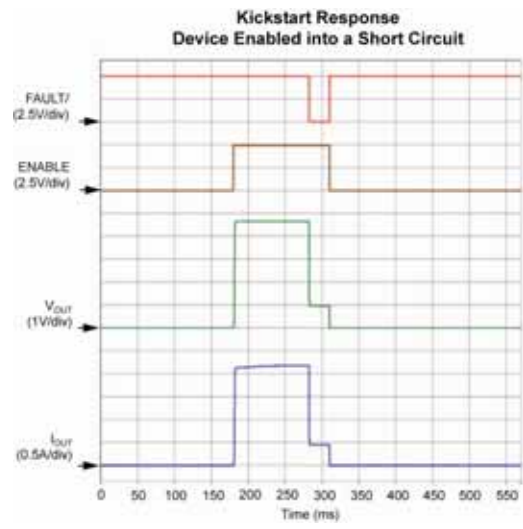
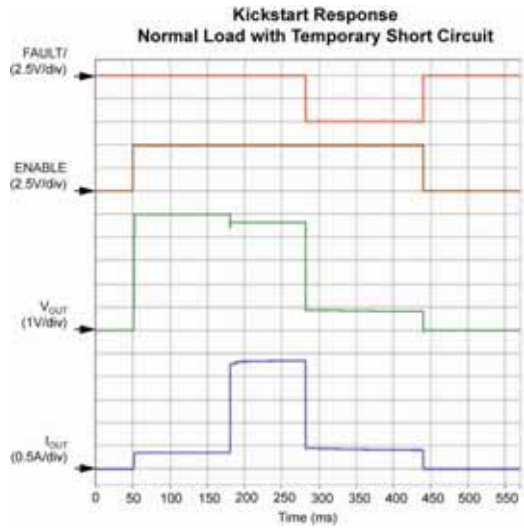
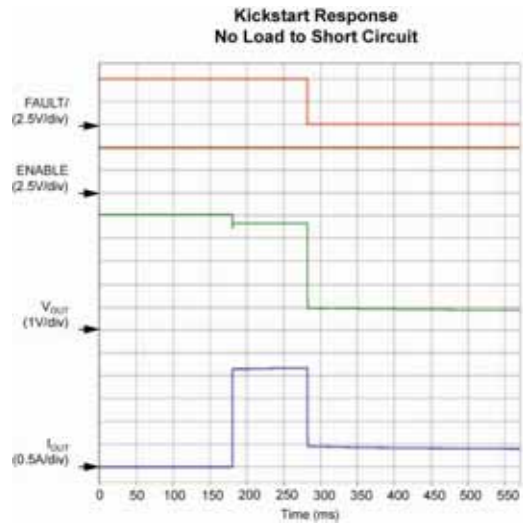
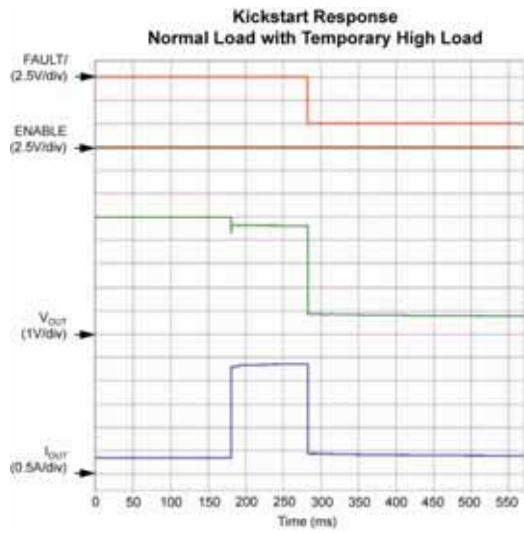

Functional Characteristics (continued)

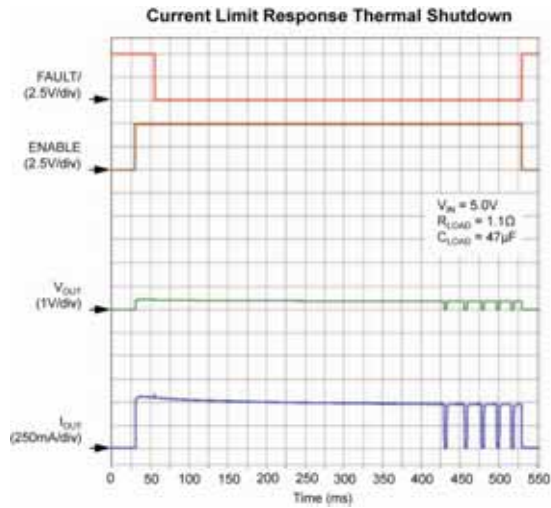
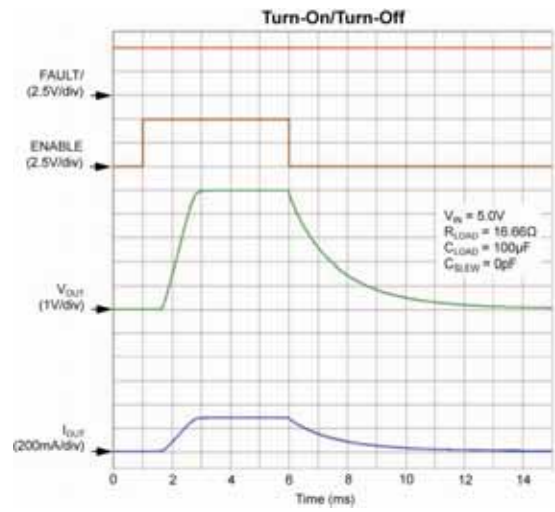
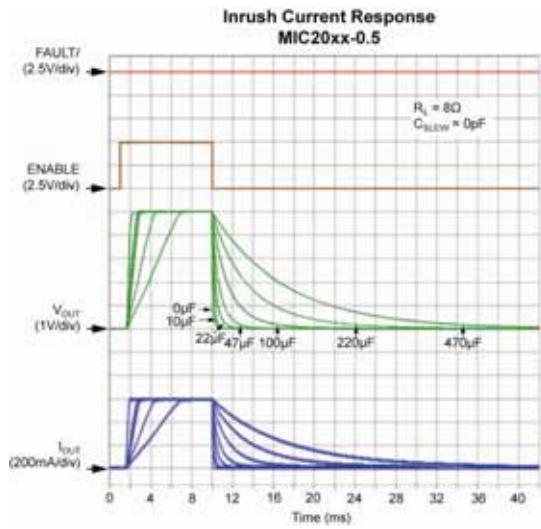

Functional Diagram

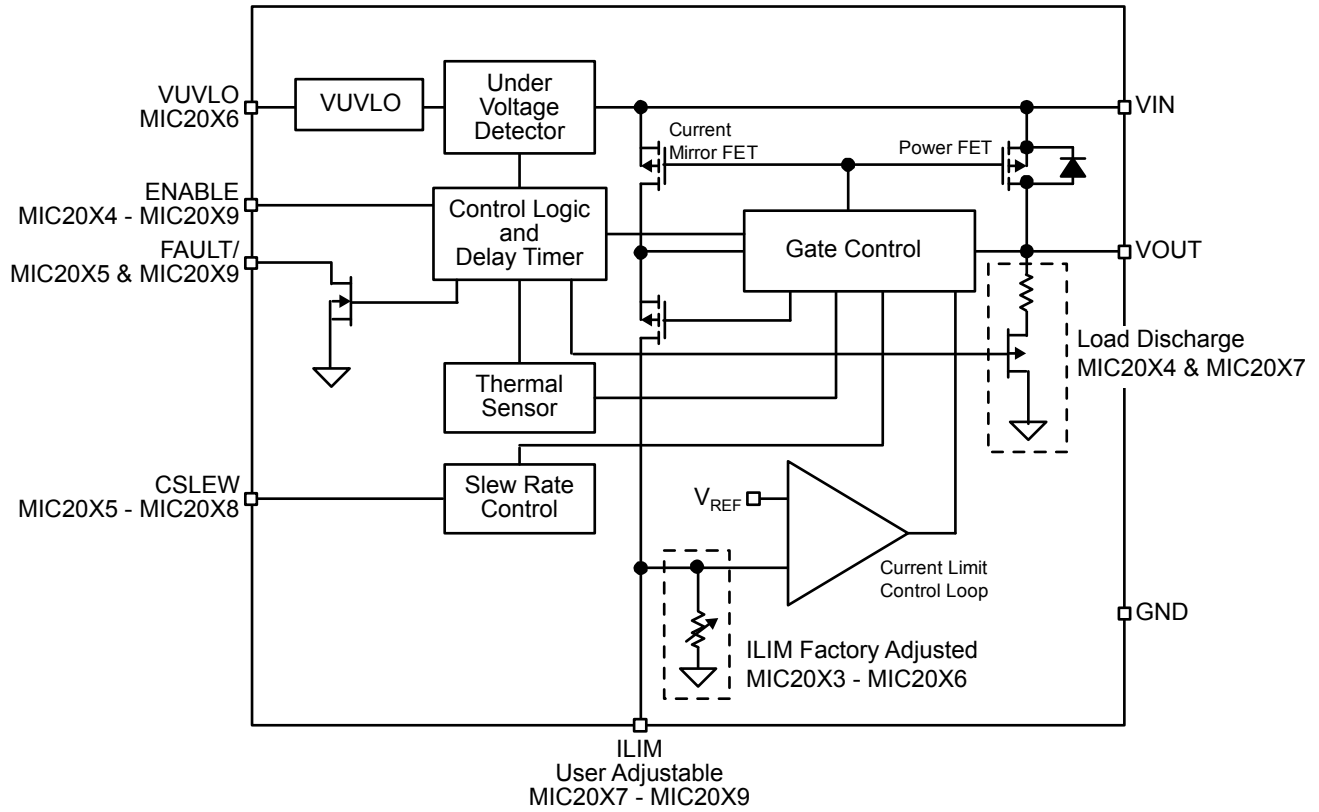

Figure 2 MIC20XX Family Functional Diagram

Functional Description

VIN and VOUT

VIN is both the power supply connection for the internal circuitry driving the switch and the input (Source connection) of the power MOSFET switch. VOUT is the Drain connection of the power MOSFET and supplies power to the load. In a typical circuit, current flows from VIN to VOUT toward the load. Since the switch is bi-directional when enabled, if VOUT is greater than VIN, current will flow from VOUT to VIN.

When the switch is disabled, current will not flow to the load, except for a small unavoidable leakage current of a few microamps. However, should VOUT exceed VIN by more than a diode drop (~0.6 V), while the switch is disabled, current will flow from output to input via the power MOSFET's body diode.

If discharging CLOAD is required by your application, consider using MIC20X4 or MIC20X7; these MIC20XX family members are equipped with a discharge FET to insure complete discharge of CLOAD.

Current Sensing and Limiting

MIC20XX protects the system power supply and load from damage by continuously monitoring current through the on-chip power MOSFET. Load current is monitored by means of a current mirror in parallel with the power MOSFET switch. Current limiting is invoked when the load exceeds the set over-current threshold. When current limiting is activated the output current is constrained to the limit value, and remains at this level until either the load/fault is removed, the load's current requirement drops below the limiting value, or the switch goes into thermal shutdown.

Kickstart

2003	2004	2005	2006	2007	2008	2009
2013	2014	2015	2016	2017	2018	2019

Only parts in white boxes have Kickstart.
(Not available in 5-pin SOT-23 packages)

The MIC201X is designed to allow momentary current surges (Kickstart) before the onset of current limiting, which permits dynamic loads, such as small disk drives or portable printers to draw the energy needed to overcome inertial loads without sacrificing system safety. In this respect, the Kickstart parts (MIC201X) differs markedly from the non-Kickstart parts (MIC200X) which immediately limit load current, potentially starving the motor and causing the appliance to stall or stutter.

During this delay period, typically 128ms, a secondary current limit is in effect. If the load demands a current in excess the secondary limit, MIC201X acts immediately to restrict output current to the secondary limit for the duration of the Kickstart period. After this time the MIC201X reverts to its normal current limit. An example

of Kickstart operation is shown below.

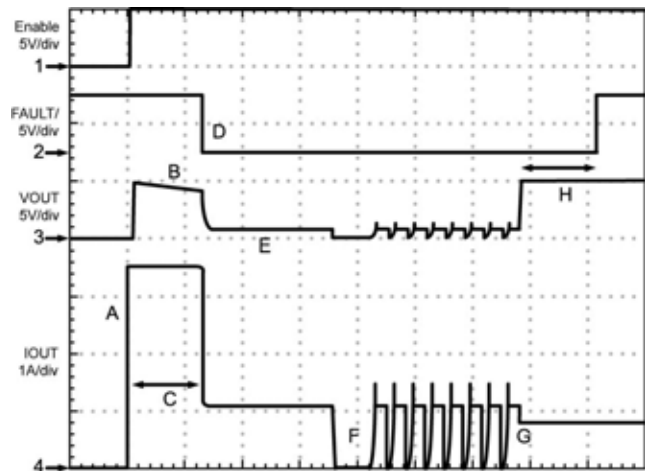

Figure 3. Kickstart Operation

Figure 3 Label Key:

- A) MIC201X is enabled into an excessive load (slew rate limiting not visible at this time scale) The initial current surge is limited by either the overall circuit resistance and power supply compliance, or the secondary current limit, whichever is less.
- B) RON of the power FET increases due to internal heating (effect exaggerated for emphasis).
- C) Kickstart period.
- D) Current limiting initiated. FAULT/ goes LOW.
- E) VOUT is non-zero (load is heavy, but not a dead short where VOUT = 0V. Limiting response will be the same for dead shorts).
- F) Thermal shutdown followed by thermal cycling.
- G) Excessive load released, normal load remains. MIC201X drops out of current limiting.
- H) FAULT/ delay period followed by FAULT/ going HIGH.

Under Voltage Lock Out

Under voltage lock-out insures no anomalous operation occurs before the device's minimum input voltage of UVLO_{THRESHOLD} which is 2V minimum, 2.25V typical, and 2.5V maximum had been achieved. Prior to reaching this voltage, the output switch (power MOSFET) is OFF and no circuit functions, such as FAULT/ or ENABLE, are considered to be valid or operative.

Variable Under Voltage Lock Out (VUVLO)

2003	2004	2005	2006	2007	2008	2009
2013	2014	2015	2016	2017	2018	2019

Only parts in white boxes have VUVLO.

VUVLO functions as an input voltage monitor when the switch is enabled. The VIN pin is monitored for a drop in voltage, indicating excessive loading of the VIN supply. When VIN is less than the VUVLO threshold voltage (V_{VUVLO_TH}) for 32ms or more, the MIC20XX disables the switch to protect the supply and allow VIN to recover. After 128ms has elapsed, the MIC20X6 enables switch. This disable and enable cycling will continue as long as VIN decreases below the VUVLO threshold voltage (V_{VUVLO_TH}) which has a typical value of 250mV. The VUVLO voltage is commonly established by a voltage divider from VIN to GND.

ENABLE

2003	2004	2005	2006	2007	2008	2009
2013	2014	2015	2016	2017	2018	2019

Only parts in white boxes have ENABLE pin.

ENABLE pin is a logic compatible input which activates the main MOSFET switch thereby providing power to the V_{OUT} pin. ENABLE is either an active HIGH or active LOW control signal. The MIC20XX can operate with logic running from supply voltages as low as 1.8V.

ENABLE may be driven higher than VIN, but no higher than 5.5V and not less than -0.3V.

FAULT/

2003	2004	2005	2006	2007	2008	2009
2013	2014	2015	2016	2017	2018	2019

Only parts in white boxes have FAULT/ pin.

FAULT/ is an N-channel open-drain output, which is asserted (LOW true) when switch either begins current limiting or enters thermal shutdown.

FAULT/ asserts after a brief delay when events occur that may be considered possible faults. This delay insures that FAULT/ is asserted only upon valid, enduring, over-current conditions and that transitory event error reports are filtered out.

In MIC200X FAULT/ asserts after a brief delay period, of 32ms typical. After a fault clears, FAULT/ remains asserted for the delay period of 32ms

MIC201X's FAULT/ asserts at the end of the Kickstart period which is 128ms typical. This masks initial current surges, such as would be seen by a motor load starting up. If the load current remains above the current limit threshold after the Kickstart has timed out, then the FAULT/ will be asserted. After a fault clears, FAULT/ remains asserted for the delay of 128ms.

Because FAULT/ is an open-drain it must be pulled HIGH with an external resistor and it may be wire-OR'd with other similar outputs, sharing a single pull-up resistor. FAULT/ may be tied to a pull-up voltage source which is higher than VIN, but no greater than 5.5V.

Soft-start Control

Large capacitive loads can create significant inrush current surges when charged through the switch. For this reason, the MIC20XX family of switches provides a built-in soft-start control to limit the initial inrush currents. Soft-start is accomplished by controlling the power MOSFET when the ENABLE pin enables the switch.

CSLEW

2003	2004	2005	2006	2007	2008	2009
2013	2014	2015	2016	2017	2018	2019

Only parts in white boxes have CSLEW pin.
(Not available in 5-pin SOT-23 packages)

The CSLEW pin is provided to increase control of the output voltage ramp at turn-on. This input allows designers the option of decreasing the output's slew rate (slowing the voltage rise) by adding an external capacitance between the CSLEW and VIN pins.

Thermal Shutdown

Thermal shutdown is employed to protect the MIC20XX family of switches from damage should the die temperature exceed safe operating levels. Thermal shutdown shuts off the output MOSFET and asserts the FAULT/ output if the die temperature reaches 145°C.

The switch will automatically resume operation when the die temperature cools down to 135°C. If resumed operation results in reheating of the die, another shutdown cycle will occur and the switch will continue cycling between ON and OFF states until the overcurrent condition has been resolved.

Depending on PCB layout, package type, ambient temperature, etc., hundreds of milliseconds may elapse from the incidence of a fault to the output MOSFET being shut off. This delay is due to thermal time constants within the system itself. In no event will the device be damaged due to thermal overload because die temperature is monitored continuously by on-chip circuitry.

Application Information

Setting I_{LIMIT}

The MIC2009/2019's current limit is user programmable and controlled by a resistor connected between the I_{LIMIT} pin and Ground. The value of this resistor is determined by the following equation:

$$I_{LIMIT} = \frac{\text{CurrentLimitFactor(CLF)}}{R_{SET}}$$

or

$$R_{SET} = \frac{\text{CurrentLimitFactor(V)}}{I_{LIMIT} \text{ (A)}}$$

For example: Set $I_{LIMIT} = 1.25 \text{ A}$

Looking in the Electrical specifications we will find CLF at $I_{LIMIT} = 1 \text{ A}$.

Min	Typ	Max	Units
190	243	293	V

For the sake of this example, we will say the typical value of CLF at an I_{OUT} of 1A is 243V. Applying the equation above:

$$R_{SET} (\Omega) = \frac{243\text{V}}{1.25\text{A}} = 194.4\Omega$$

$$R_{SET} = 196\Omega$$

(the closest standard 1% value)

Designers should be aware that variations in the measured I_{LIMIT} for a given R_{SET} resistor, will occur because of small differences between individual ICs (inherent in silicon processing) resulting in a spread of I_{LIMIT} values. In the example above we used the typical value of CLF to calculate R_{SET} . We can determine I_{LIMIT} 's spread by using the minimum and maximum values of CLF and the calculated value of R_{SET} .

$$I_{LIMIT_MIN} = \frac{190\text{V}}{196\Omega} = 0.97\text{A}$$

$$I_{LIMIT_MAX} = \frac{260\text{V}}{196\Omega} = 1.5\text{A}$$

Giving us a maximum I_{LIMIT} variation over temperature of:

$$\begin{matrix} I_{LIMIT_MIN} & I_{LIMIT_TYP} & I_{LIMIT_MAX} \\ 0.97 \text{ A} & 1.25 \text{ A} & 1.5 \text{ A} \end{matrix}$$

or $1.25 \text{ A} - 22\%$ and $1.25 \text{ A} + 20\%$

I_{LIMIT} vs. I_{OUT} measured

The MIC20XX's current limiting circuitry, during current limiting, is designed to act as a constant current source to the load. As the load tries to pull more than the allotted current, V_{OUT} drops and the input to output voltage differential increases. When $V_{IN} - V_{OUT}$ exceeds 1V, I_{OUT} drops below I_{LIMIT} to reduce the drain of fault current on the system's power supply and to limit internal heating of the switch.

When measuring I_{OUT} it is important to bear this voltage dependence in mind, otherwise the measurement data may appear to indicate a problem when none really exists. This voltage dependence is illustrated in Figures 4 and 5.

In Figure 4 output current is measured as V_{OUT} is pulled below V_{IN} , with the test terminating when V_{OUT} is 1V below V_{IN} . Observe that once I_{LIMIT} is reached I_{OUT} remains constant throughout the remainder of the test. In Figure 5 this test is repeated but with $V_{IN} - V_{OUT}$ exceeding 1V.

When $V_{IN} - V_{OUT} > 1\text{V}$, switch's current limiting circuitry responds by decreasing I_{OUT} , as can be seen in Figure 5. In this demonstration, V_{OUT} is being controlled and I_{OUT} is the measured quantity. In real life applications V_{OUT} is determined in accordance with Ohm's law by the load and the limiting current.

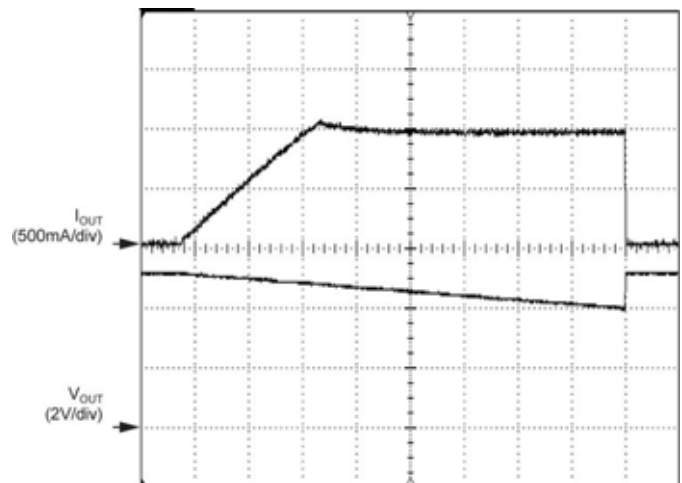

Figure 4. I_{OUT} in Current Limiting for $V_{IN} - V_{OUT} \leq 1\text{V}$

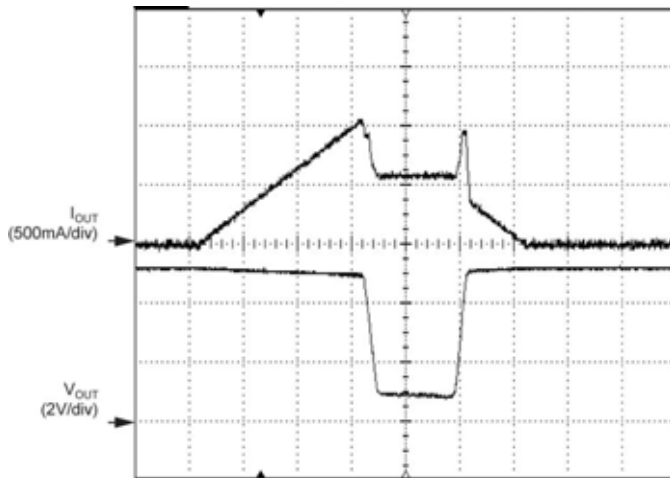

Figure 5. I_{OUT} in Current Limiting for $V_{IN} - V_{OUT} > 1V$

This folding back of I_{LIMIT} can be generalized by plotting I_{LIMIT} as a function of V_{OUT} , as shown below in Figures 6 and 7. The slope of V_{OUT} between $I_{OUT} = 0V$ and $I_{OUT} = I_{LIMIT}$ (where $I_{LIMIT} = 1A$) is determined by R_{ON} of the switch and I_{LIMIT} .

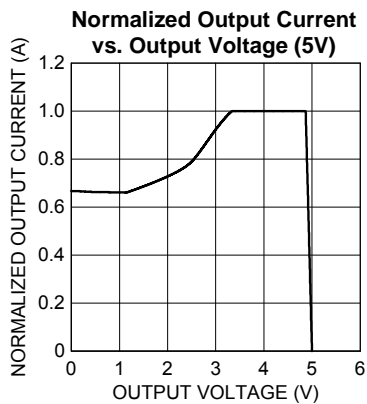

Figure 6.

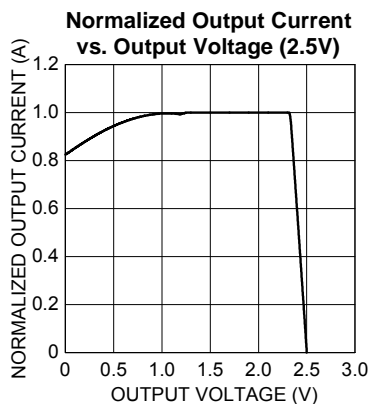

Figure 7.

CSLEW

2003	2004	2005	2006	2007	2008	2009
2013	2014	2015	2016	2017	2018	2019

Only parts in white boxes have CSLEW pin.
(Not available in 5-pin SOT-23 packages).

The CSLEW pin is provided to increase control of the output voltage ramp at turn-on. This input allows designers the option of decreasing the output's slew rate (slowing the voltage rise) by adding an external capacitance between the CSLEW and VIN pins. This capacitance slows the rate at which the pass FET gate voltage increases and thus, slows both the response to an Enable command as well as V_{OUT} 's ascent to its final value.

Figure 8 illustrates effect of C_{SLEW} on turn-on delay and output rise time.

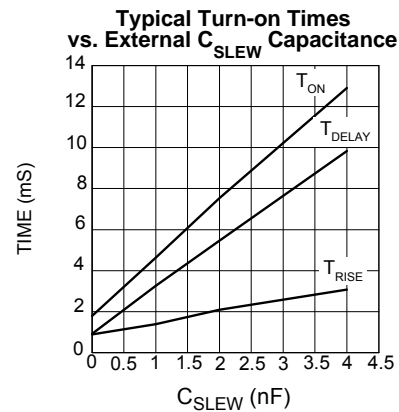

Figure 8.

C_{SLEW} 's effect on I_{LIMIT}

An unavoidable consequence of adding C_{SLEW} capacitance is a reduction in the MIC20X5 – 20X8's ability to quickly limit current transients or surges. A sufficiently large capacitance can prevent both the primary and secondary current limits from acting in time to prevent damage to the MIC20X5 – 20X8 or the system from a short circuit fault. For this reason, the upper limit on the value of C_{SLEW} is 4nF.

Variable Under Voltage Lock Out (VUVLO)

2003	2004	2005	2006	2007	2008	2009
2013	2014	2015	2016	2017	2018	2019

Only parts in white boxes have VUVLO pin and functionality.

Power conscious systems, such as those implementing ACPI, will remain active even in their low power states and may require the support of external devices through both phases of operation. Under these conditions, the current allowed these external devices may vary according to the system's operating state and as such

require dual current limits on their peripheral ports. The MIC20X6 is designed for systems demanding two primary current limiting levels but without the use of a control signal to select between current limits.

To better understand how the MIC20X6 provides this, imagine a system whose main power supply supports heavy loads during normal operation, but in sleep mode is reduced to only few hundred milliamps of output current. In addition, this system has several USB ports which must remain active during sleep. In normal operation, each port can support a 500mA peripheral, but in sleep mode their combined output current is limited to what the power supply can deliver minus whatever the system itself is drawing.

If a peripheral device is plugged in which demands more current than is available, the system power supply will sag, or crash. The MIC20X6 prevents this by monitoring both the load current and V_{IN} . During normal operation, when the power supply can source plenty of current, the MIC20X6 will support any load up to its factory programmed current limit. When the weaker, standby supply is in operation, the MIC20X6 monitors V_{IN} and will shut off its output should V_{IN} dip below a predetermined value. This predetermined voltage is user programmable and set by the selection of the resistor divider driving the VUVLO pin.

To prevent false triggering of the VUVLO feature, the MIC20X6 includes a delay timer to blank out momentary excursions below the VUVLO trip point. If V_{IN} stays below the VUVLO trip point for longer than 32ms (typical), then the load is disengaged and the MIC20X6 will wait 128ms before reapplying power to the load. If V_{IN} remains below the VUVLO trip point, then the load will be powered for the 32ms blanking period and then again disengaged. This is illustrated in the scope plot below. If V_{IN} remains above the VUVLO trip point MIC20X6 resumes normal operation.

VUVLO and Kickstart operate independently in the MIC2016. If the high current surge allowed by Kickstart causes V_{IN} to dip below the VUVLO trip point for more than 32ms, VUVLO will disengage the load even though the Kickstart timer has not timed out.

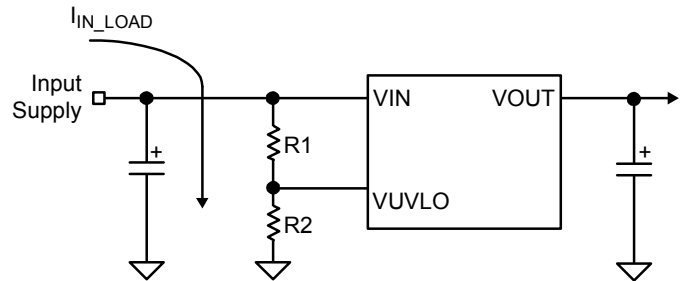

Calculating VUVLO resistor divider values

Selection of R_1 and R_2 is driven by the input voltage at which VUVLO should go into effect and the allowed loading of the input supply. The VUVLO pin input voltage is the result of the voltage division of V_{IN} by the voltage divider comprised of R_1 and R_2 . We know $V_{VUVLO_TH} = 250\text{ mV}$, then by choosing a V_{IN} trip voltage (V_{TRIP}) we know the voltage divider ratio formed by R_1 and R_2 . Then an R_2 is chosen such that the series resistance $R_1 + R_2$ results in a small I_{IN_LOAD} .

And then the VUVLO trip voltage as it relates to the comparator threshold and the resistor divider:

$$\frac{V_{VUVLO_TH}}{V_{TRIP}} = \frac{R_2}{(R_2 + R_1)} = X$$

Rearranging these:

$$R_1 = \frac{X}{(1 - X)} * R_2$$

Choose an R_2 that minimizes the I_{IN_LOAD} current yet at the same time is less than input impedance of the VUVLO pin. The VUVLO pin internally is connected to a comparator with an extremely high input impedance. It is recommended that R_2 not exceed 1 M Ω . R_2 can then be calculated from the equation above.

For example:

$$\begin{aligned} V_{TRIP} &= 4.75\text{V for a 5V supply} \\ V_{VUVLO_TH} &= 250\text{mV} \\ R_2 &= 750\text{k}\Omega \end{aligned}$$

Substituting these values into the equation above:

$$\begin{aligned} X &= \frac{V_{VUVLO_TH}}{V_{TRIP}} = \frac{4.75\text{ V}}{0.25\text{ V}} = 0.05263 \\ R_1 &= \frac{0.05263}{(1 - 0.05263)} * 750\text{ k}\Omega = 41,667\text{k}\Omega \\ R_1 &= 41,667\text{k}\Omega \end{aligned}$$

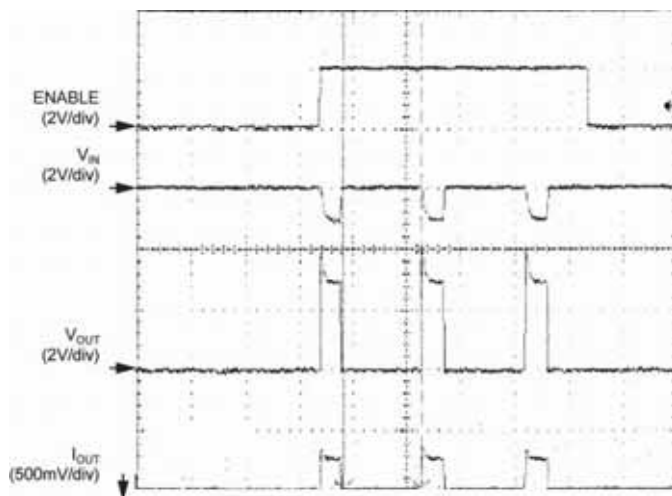

Figure 9. VUVLO Operation

In this example we have used the nominal value of V_{VUVLO_TH} . By substituting in the min and max values of V_{VUVLO_TH} , R_1 and R_2 the VUVLO trip point window can be established.

The VUVLO comparator uses no Hysteresis. This is because the VUVLO blanking timer prevents any chattering that might otherwise occur if V_{IN} varies about the trigger point. The timer is reset by upward crossings of the trip point such that V_{IN} must remain below the trip point for the full 32ms period for load disengagement to occur.

In selecting a V_{TRIP} voltage the designer is cautioned to not make this value less than 2.5V. A minimum of 2.5V is required for the MIC20X6's internal circuitry to operate properly. VUVLO trip points below 2.5V will result in erratic or unpredictable operation.

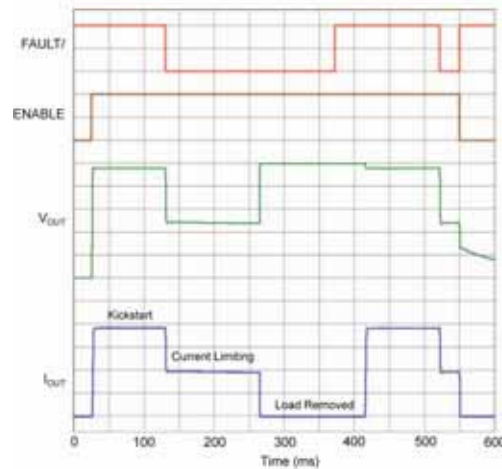

Figure 10. Kickstart

Kickstart

2003	2004	2005	2006	2007	2008	2009
2013	2014	2015	2016	2017	2018	2019

Only parts in white boxes have Kickstart.
(Not available in 5-pin SOT-23 packages).

Kickstart allows brief current surges to pass to the load before the onset of normal current limiting, which permits dynamic loads to draw bursts of energy without sacrificing system safety.

Functionally, Kickstart is a forced override of the normal current limiting function provided by the switch. The Kickstart period is governed by an internal timer which allows current to pass up to the secondary current limit (I_{LIMIT_2nd}) to the load for 128ms and then normal (primary) current limiting goes into action.

During Kickstart a secondary current limiting circuit is monitoring output current to prevent damage to the switch, as a hard short combined with a robust power supply can result in currents of many tens of amperes. This secondary current limit is nominally set at 4A and reacts immediately and independently of the Kickstart period. Once the Kickstart timer has finished its count the primary current limiting circuit takes over and holds I_{OUT} to its programmed limit for as long as the excessive load persists.

Once the switch drops out of current limiting the Kickstart timer initiates a lock-out period of 128ms such that no further bursts of current above the primary current limit, will be allowed until the lock-out period has expired.

Kickstart may be over-riden by the thermal protection circuit and if sufficient internal heating occurs, Kickstart will be terminated and $I_{OUT} \rightarrow 0A$. Upon cooling, if the load is still present $I_{OUT} \rightarrow I_{LIMIT}$, not I_{LIMIT_2nd} .

Automatic Load Discharge

2003	2004	2005	2006	2007	2008	2009
2013	2014	2015	2016	2017	2018	2019

Only parts in white boxes have automatic load discharge.

Automatic discharge is a valuable feature when it is desirable to quickly remove charge from the VOUT pin. This allows for a quicker power-down of the load. This also prevents any charge from being presented to a device being connected to the VOUT pin, for example, USB, 1394, PCMCIA, and CableCARD™.

Automatic discharge is performed by a shunt MOSFET from VOUT pin to GND. When the switch is disabled, a break before make action is performed turning off the main power MOSFET and then enabling the shunt MOSFET. The total resistance of the MOSFET and internal resistances is typically 126Ω.

Supply Filtering

A minimum 1μF bypass capacitor positioned close to the VIN and GND pins of the switch is both good design practice and required for proper operation of the switch. This will control supply transients and ringing. Without a bypass capacitor, large current surges or a short may cause sufficient ringing on VIN (from supply lead inductance) to cause erratic operation of the switch's control circuitry. For best performance good quality, low ESR capacitors are recommended, preferably ceramic.

When bypassing with capacitors of 10μF and up, it is good practice to place a smaller value capacitor in parallel with the larger to handle the high frequency components of any line transients. Values in the range of 0.01μF to 0.1μF are recommended. Again, good quality, low ESR capacitors should be chosen.

Power Dissipation

Power dissipation depends on several factors such as the load, PCB layout, ambient temperature, and supply voltage. Calculation of power dissipation can be accomplished by the following equation:

$$P_D = R_{DS(ON)} \times (I_{OUT})^2$$

To relate this to junction temperature, the following equation can be used:

$$T_J = P_D \times R_{\theta(J-A)} + T_A$$

Where: T_J = junction temperature,

T_A = ambient temperature

$R_{\theta(J-A)}$ is the thermal resistance of the package

In normal operation the switch's R_{ON} is low enough that no significant I^2R heating occurs. Device heating is most often caused by a short circuit, or very heavy load, when a significant portion of the input supply voltage appears across the switch's power MOSFET. Under these conditions the heat generated will exceed the package and PCB's ability to cool the device and thermal limiting will be invoked.

In Figure 11 die temperature is plotted against I_{OUT} assuming a constant case temperature of 85°C. The plots also assume a worst case R_{ON} of 140mΩ at a die temperature of 135°C. Under these conditions it is clear that an SOT-23 packaged device will be on the verge of thermal shutdown, typically 140°C die temperature, when operating at a load current of 1.25A. For this reason we recommend using MLF[®] packaged switch s for any design intending to supply continuous currents of 1A or more.

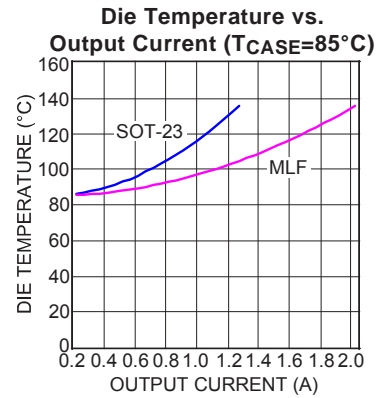
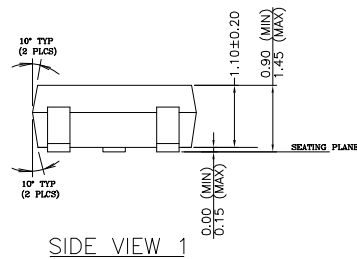
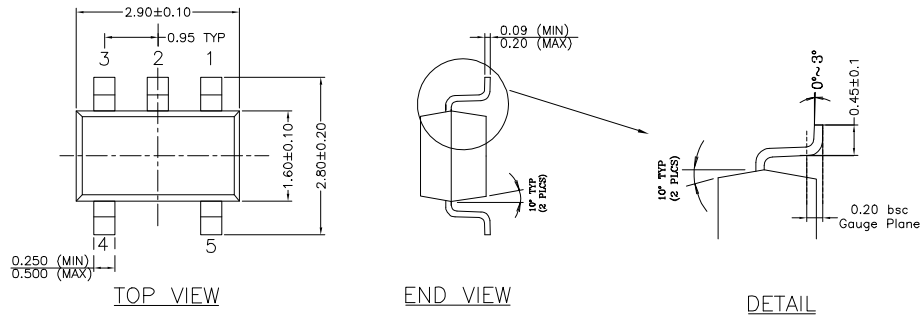

Figure 11. Die Temperature vs. I_{OUT}

Package Information



NOTE:
 1. PACKAGE OUTLINE EXCLUSIVE OF MOLD FLASH & BURR.
 2. PACKAGE OUTLINE INCLUSIVE OF SOLER PLATING.
 3. DIMENSION AND TOLERANCE PER ANSI Y14.5M, 1982.
 4. FOOT LENGTH MEASUREMENT BASED ON GAUGE PLANE METHOD.
 5. DIE FACES UP FOR MOLD, AND FACES DOWN FOR TRIM/FORM.
 6. ALL DIMENSIONS ARE IN MILLIMETERS.

5-Pin SOT-23 (M5)

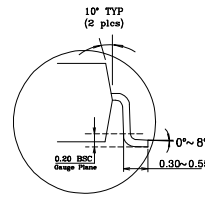
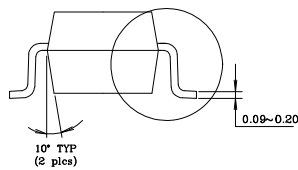
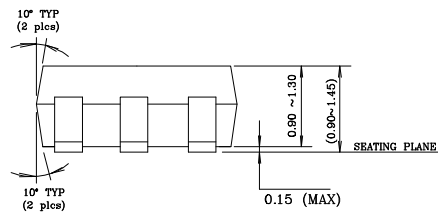
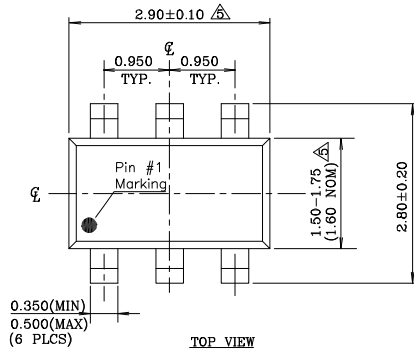

NOTE:
 1. Dimensions and tolerances are as per ANSI Y14.5M, 1982.
 2. Package surface to be mirror finish.
 3. Die is facing up for mold. Die is facing down for trim/form, ie. reverse trim/form.
 4. The footlength measuring is based on the gauge plane method.
 5. Dimension are exclusive of mold flash & gate burr.

6-Pin SOT-23 (M6)

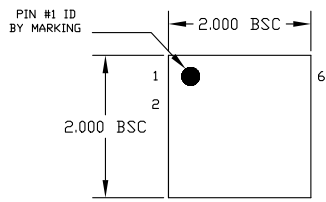

TOP VIEW

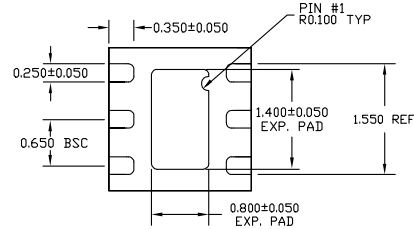

BOTTOM VIEW

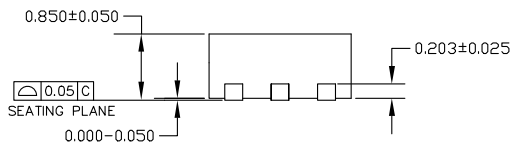

SIDE VIEW

- NOTE:
1. ALL DIMENSIONS ARE IN MILLIMETERS.
 2. MAX. PACKAGE WARPAGE IS 0.05 mm.
 3. MAXIMUM ALLOWABLE BURRS IS 0.076 mm IN ALL DIRECTIONS.
 4. PIN #1 ID ON TOP WILL BE LASER MARKED.

6 Pin 2mm x 2mm MLF[®] (ML)

MICREL, INC. 2180 FORTUNE DRIVE SAN JOSE, CA 95131 USA
 TEL +1 (408) 944-0800 FAX +1 (408) 474-1000 WEB <http://www.micrel.com>

The information furnished by Micrel in this data sheet is believed to be accurate and reliable. However, no responsibility is assumed by Micrel for its use. Micrel reserves the right to change circuitry and specifications at any time without notification to the customer.

Micrel Products are not designed or authorized for use as components in life support appliances, devices or systems where malfunction of a product can reasonably be expected to result in personal injury. Life support devices or systems are devices or systems that (a) are intended for surgical implant into the body or (b) support or sustain life, and whose failure to perform can be reasonably expected to result in a significant injury to the user. A Purchaser's use or sale of Micrel Products for use in life support appliances, devices or systems is a Purchaser's own risk and Purchaser agrees to fully indemnify Micrel for any damages resulting from such use or sale.

© 2008 Micrel, Incorporated.