

GENERAL SPECIFICATIONS FOR S301 ~ S339

Electrical Capacity (Resistive & Inductive Load)

Power Level: Shown in the following tables

Other Ratings

- Contact Resistance:** 10 milliohms maximum
- Insulation Resistance:** 1,000 megohms minimum @ 500V DC
- Dielectric Strength:** 2,000V AC minimum for 1 minute minimum
- Mechanical Life:** 50,000 operations minimum
- Electrical Life:** 6,000 operations minimum for S331F; 15,000 operations minimum for all other S331s; 25,000 operations minimum for all others
- Angle of Throw (α):** Shown on following tables

Materials & Finishes

- Toggle:** PBT for flatted lever; brass with chrome plating for all others
- Bushing:** Brass with chrome plating
- Case:** Melamine phenol
- Case Cover:** Steel with zinc plating
- Movable Contact:** Copper with silver plating
- Movable & Stationary Contacts:** Silver alloy capped on copper with silver plating
- Terminals:** Brass with silver plating

Installation

- Mounting Torque:** 2.94Nm (26 lb•in) for double nut; 1.47Nm (13 lb•in) for single nut
- Soldering Time & Temperature:** Manual Soldering: See Profile A in Supplement section.

Standards & Certifications

- UL Recognized:** Designated with UL recognized symbol beside part numbers on following pages
UL File No. WOYR2.E44145. Add "/U" to end of part number to order UL mark on switch.
- C-UL Recognized:** Designated with C-UL recognized symbol beside part numbers on following pages
C-UL File No. WOYR8.E44145. Add "/C-UL" to end of part number to order C-UL mark on switch.
- CSA Certified:** Designated with CSA certified symbol beside part numbers on following pages
File No. 023535-0-000. Add "/C" to end of part number to order CSA mark on switch.

SINGLE POLE WITH SOLDER LUG

Model	Approvals	Pole & Throw	Toggle Position/Connected Terminals () = Momentary						Electrical Capacity				Angle of Throw
			Down		Center	Up		Resistive			Inductive		
			Keyway	Keyway	Keyway	Keyway	Keyway	Keyway	AC 125V	AC 250V	DC 30V	AC 125V PF 0.6	
S301	UL, UL, SF	SPST	ON	1-3	NONE	OFF	—	15A	6A	20A	10A	32°	
S302	UL, UL, SF	SPDT	ON	2-3	NONE	ON	2-1	15A	6A	20A	10A	32°	
S303	UL, UL, SF	SPDT	ON	2-3	OFF	ON	2-1	15A	6A	20A	10A	32°	
S305	—	SPDT	ON	2-3	NONE	(ON)	2-1	15A	6A	20A	8A	32°	
S308	—	SPDT	(ON)	2-3	OFF	(ON)	2-1	15A	6A	20A	8A	32°	
S309	—	SPDT	ON	2-3	OFF	(ON)	2-1	15A	6A	20A	8A	32°	

Throw & Schematics:

Note: Terminal numbers are actually on the switch

- Standard Hardware: AT503M Face Hex Nut, AT506 Locking Ring, AT508 Lockwasher, AT527M Backup Hex Nut. See Accessories & Hardware section.





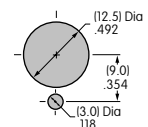
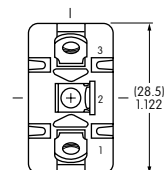
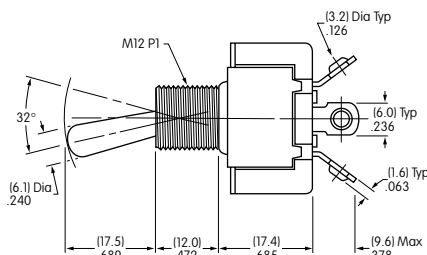
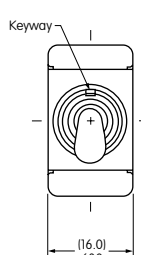















S301



Maximum Panel Thickness: .185" (4.7mm)

S301 does not have terminal 2

DOUBLE POLE WITH SOLDER LUG

Model	Approvals	Pole & Throw	Toggle Position/Connected Terminals () = Momentary			Electrical Capacity				α = Angle of Throw
			Down 	Center 	Up 	Resistive			Inductive	
						AC 125V	AC 250V	DC 30V	AC 125V PF 0.6	
S331	  	DPST	ON 1-3 4-6	NONE	OFF —	25A	25A	25A	10A	25°
S332	  	DPDT	ON 2-3 5-6	NONE	ON 2-1 5-4	25A	15A	25A	10A	25°
S333	  	DPDT	ON 2-3 5-6	OFF	ON 2-1 5-4	25A	15A	25A	10A	30°
S335	  	DPDT	ON 2-3 5-6	NONE	(ON) 2-1 5-4	15A	6A	20A	8A	25°
S338	  —	DPDT	(ON) 2-3 5-6	OFF	(ON) 2-1 5-4	15A	6A	20A	8A	25°
S339	  —	DPDT	ON 2-3 5-6	OFF	(ON) 2-1 5-4	15A	6A	20A	8A	25°

Throw & Schematics:



Note: Terminal numbers are actually on the switch

• Standard Hardware: AT503M Face Hex Nut, AT506 Locking Ring, AT508 Lockwasher, AT527M Backup Hex Nut. See Accessories & Hardware section.





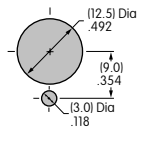
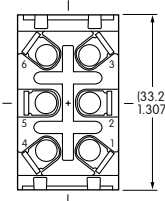
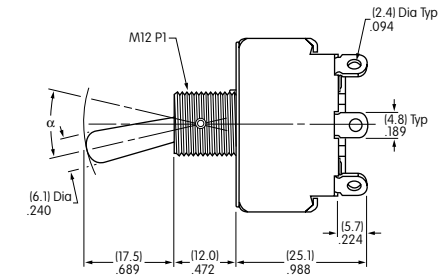
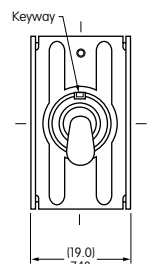









S331



S331 does not have terminals 2 & 5

Maximum Panel Thickness: .185" (4.7mm)

DOUBLE POLE WITH SOLDER LUG & FLATTED LEVER

Model	Approvals	Pole & Throw	Toggle Position/Connected Terminals () = Momentary			Electrical Capacity				α = Angle of Throw
			Down 	Center 	Up 	Resistive			Inductive	
						AC 125V	AC 250V	DC 30V	AC 125V PF 0.6	
S331R	  —	DPST	ON 1-3 4-6	NONE	OFF —	25A	25A	25A	10A	25°
S332R	  —	DPDT	ON 2-3 5-6	NONE	ON 2-1 5-4	25A	15A	25A	10A	25°
S333R	  —	DPDT	ON 2-3 5-6	OFF	ON 2-1 5-4	25A	15A	25A	10A	30°
S338R	  —	DPDT	(ON) 2-3 5-6	OFF	(ON) 2-1 5-4	15A	6A	20A	8A	25°
S339R	  —	DPDT	ON 2-3 5-6	OFF	(ON) 2-1 5-4	15A	6A	20A	8A	25°

Throw & Schematics:



Note: Terminal numbers are actually on the switch

• Standard Hardware: AT504M Knurled Nut, AT508 Lockwasher, AT527M Backup Hex Nut. See Accessories & Hardware section.





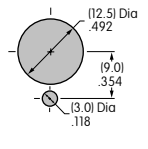
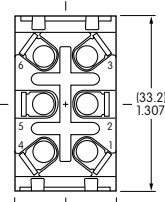
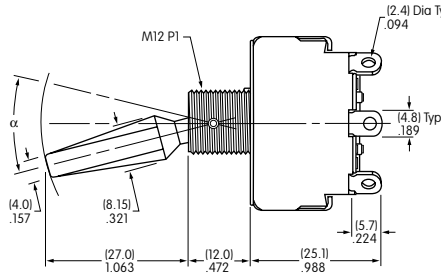
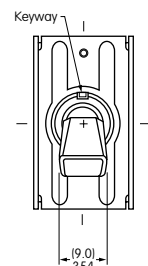











S331R



S331R does not have terminals 2 & 5

Maximum Panel Thickness: .220" (5.6mm)

SINGLE POLE WITH SCREW LUG

Model	Approvals	Pole & Throw	Toggle Position/Connected Terminals () = Momentary						Electrical Capacity				α = Angle of Throw
			Down 	Center 	Up 	Resistive			Inductive				
						AC 125V	AC 250V	DC 30V	AC 125V PF 0.6				
S301T	  	SPST	ON 1-3	NONE	OFF —	15A	6A	20A	10A	32°			
S302T	  	SPDT	ON 2-3	NONE	ON 2-1	15A	6A	20A	10A	32°			
S303T	  	SPDT	ON 2-3	OFF	ON 2-1	15A	6A	20A	10A	32°			
S305T	— — 	SPDT	ON 2-3	NONE	(ON) 2-1	15A	6A	20A	8A	32°			
S308T	— — 	SPDT	(ON) 2-3	OFF	(ON) 2-1	15A	6A	20A	8A	32°			
S309T	— — 	SPDT	ON 2-3	OFF	(ON) 2-1	15A	6A	20A	8A	32°			

Throw & Schematics:



Note: Terminal numbers are actually on the switch

- Standard Hardware: AT503M Face Hex Nut, AT506 Locking Ring, AT508 Lockwasher, AT527M Backup Hex Nut. See Accessories & Hardware section.





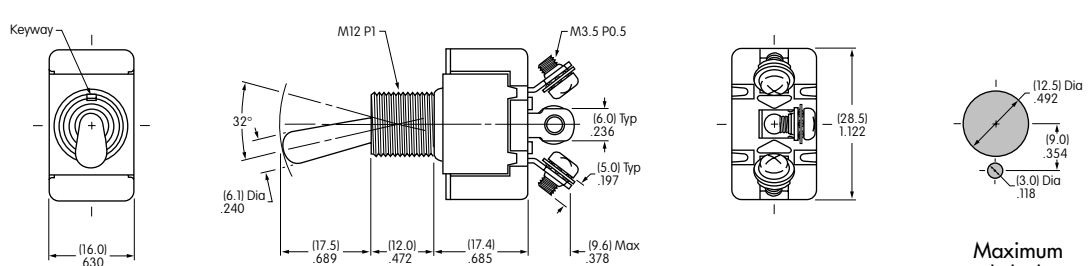











S301T



S301T does not have terminal 2

Maximum Panel Thickness: .185" (4.7mm)

DOUBLE POLE WITH SCREW LUG

Model	Approvals	Pole & Throw	Toggle Position/Connected Terminals () = Momentary						Electrical Capacity				α = Angle of Throw
			Down 	Center 	Up 	Resistive			Inductive				
						AC 125V	AC 250V	DC 30V	AC 125V PF 0.6				
S331T	  —	DPST	ON 1-3 4-6	NONE	OFF —	15A	15A	15A	10A	25°			
S332T	  —	DPDT	ON 2-3 5-6	NONE	ON 2-1 5-4	15A	15A	15A	10A	25°			
S333T	  —	DPDT	ON 2-3 5-6	OFF	ON 2-1 5-4	15A	15A	15A	10A	30°			
S335T	  —	DPDT	ON 2-3 5-6	NONE	(ON) 2-1 5-4	15A	6A	20A	8A	25°			
S338T	  —	DPDT	(ON) 2-3 5-6	OFF	(ON) 2-1 5-4	15A	6A	20A	8A	25°			
S339T	  —	DPDT	ON 2-3 5-6	OFF	(ON) 2-1 5-4	15A	6A	20A	8A	25°			

Throw & Schematics:



Note: Terminal numbers are actually on the switch

- Standard Hardware: AT503M Face Hex Nut, AT506 Locking Ring, AT508 Lockwasher, AT527M Backup Hex Nut. See Accessories & Hardware section.





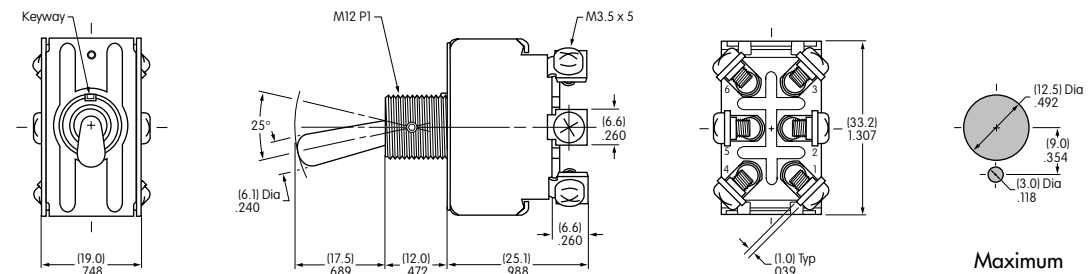

S331T



S331T does not have terminals 2 & 5

Maximum Panel Thickness: .185" (4.7mm)

SINGLE POLE WITH QUICK CONNECT

Model	Approvals	Pole & Throw	Toggle Position/Connected Terminals			Electrical Capacity				α = Angle of Throw
			Down 	Center 	Up 	Resistive			Inductive	
						AC 125V	AC 250V	DC 30V	AC 125V PF 0.6	
S301F		SPST	ON 1-3	NONE	OFF —	15A	6A	20A	10A	32°

Throw & Schematics: SPST  INTERNAL CONNECTION

Note: Terminal numbers are actually on the switch

• Standard Hardware: AT503M Face Hex Nut, AT506 Locking Ring, AT508 Lockwasher, AT527M Backup Hex Nut. See Accessories & Hardware section.





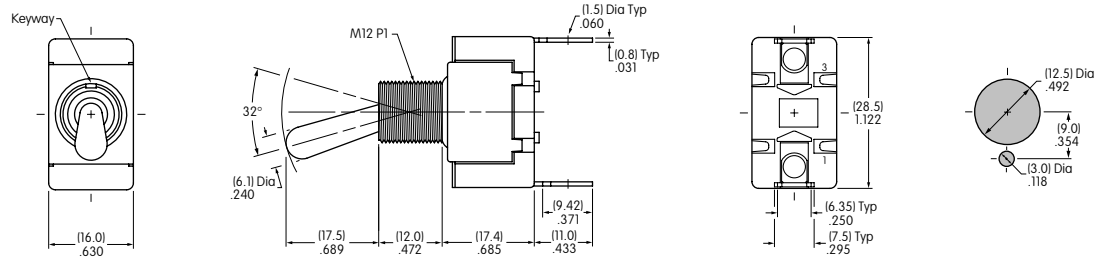





S301F

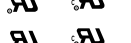

Maximum Panel Thickness: .185" (4.7mm)

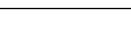
DOUBLE POLE WITH QUICK CONNECT

Model	Approvals	Pole & Throw	Toggle Position/Connected Terminals () = Momentary			Electrical Capacity				α = Angle of Throw
			Down 	Center 	Up 	Resistive			Inductive	
						AC 125V	AC 250V	DC 30V	AC 125V PF 0.6	
S331F		DPST	ON 1-3 4-6	NONE	OFF —	25A	25A	25A	10A	25°
S332F		DPDT	ON 2-3 5-6	NONE	ON 2-1 5-4	25A	15A	25A	10A	25°
S333F		DPDT	ON 2-3 5-6	OFF	ON 2-1 5-4	25A	15A	25A	10A	30°
S335F		DPDT	ON 2-3 5-6	NONE	(ON) 2-1 5-4	15A	6A	20A	8A	25°

Throw & Schematics: DPST  INTERNAL CONNECTION DPDT  (COM) 5

Note: Terminal numbers are actually on the switch

• Standard Hardware: AT503M Face Hex Nut, AT506 Locking Ring, AT508 Lockwasher, AT527M Backup Hex Nut. See Accessories & Hardware section.



S332F

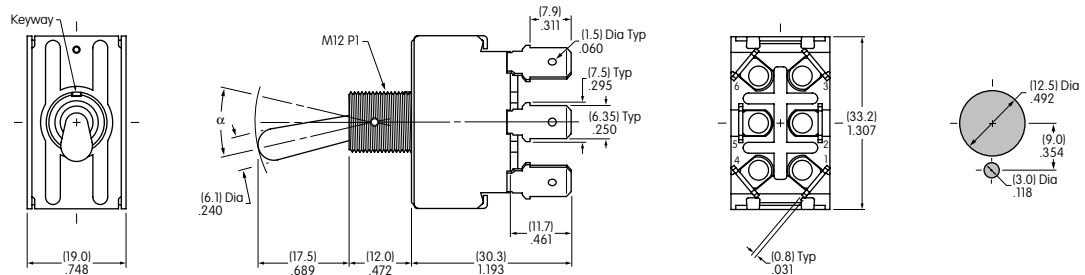

Maximum Panel Thickness: .185" (4.7mm)

S331F does not have terminals 2 & 5

GENERAL SPECIFICATIONS FOR S31 ~ S49

Electrical Capacity (Resistive & Inductive Load)

Power Level: Shown in the following tables

Other Ratings

- Contact Resistance:** 10 milliohms maximum
- Insulation Resistance:** 1,000 megohms minimum @ 500V DC
- Dielectric Strength:** 2,000V AC minimum for 1 minute minimum
- Mechanical Life:** 50,000 operations minimum
- Electrical Life:** 25,000 operations minimum
- Angle of Throw (α):** Shown on following tables

Materials & Finishes

- Toggle:** PBT resin for flatted lever; brass with chrome plating for all others
- Bushing:** Brass with chrome plating
- Case:** Phenolic resin
- Case Cover:** Steel with chromate plating over zinc plating
- Movable Contactor:** Copper with silver plating
- Movable Contacts:** Silver alloy capped on copper with silver plating
- Stationary Contacts:** Silver alloy capped on copper with silver plating
- Terminals:** Brass with silver plating

Environmental Data

Operating Temp Range: -10°C through +70°C (+14°F through +158°F)









Installation

- Mounting Torque:** 2.94Nm (26 lb•in) for double nut
- Maximum Panel Thickness:** Shown beneath panel cutout in switch dimension drawings
- Soldering Time & Temperature:** Manual Soldering: See Profile A in Supplement section.

Standards & Certifications

- UL Recognized:** Designated with UL recognized symbol beside part numbers on following pages. See Supplement section to find UL rating details. UL File No. WOYR2.E44145
Add "/U" to end of part number to order UL mark on switch.
- C-UL Recognized:** Designated with C-UL recognized symbol beside part numbers on following pages. See Supplement section to find C-UL rating details. C-UL File No. WOYR8.E44145
Add "/C-UL" to end of part number to order C-UL mark on switch.
- CSA Certified:** Designated with CSA certified symbol beside part numbers on following pages. See Supplement section to find CSA rating details. File No. 023535-0-000
Add "/C" to end of part number to order CSA mark on switch.

THREE POLE WITH SOLDER LUG

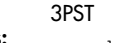



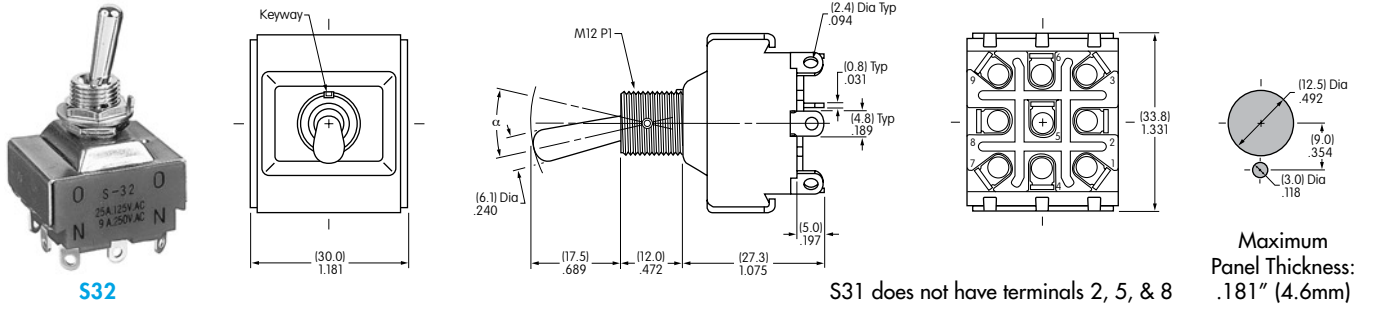

*See Supplement section for UL detail			Toggle Position/Connected Terminals () = Momentary						Electrical Capacity				α = Angle of Throw
Model	Approvals	Pole & Throw	Down 	Center 	Up 	Resistive			Inductive				
						AC 125V	AC 250V	DC 30V	AC 125V PF 0.6				
S31		3PST	ON 1-3 4-6 7-9	NONE	OFF —	25A	9A	20A	10A	25°			
S32		3PDT	ON 2-3 5-6 8-9	NONE	ON 2-1 5-4 8-7	25A	9A	20A	10A	25°			
S33		3PDT	ON 2-3 5-6 8-9	OFF	ON 2-1 5-4 8-7	25A	9A	20A	10A	30°			
S35		3PDT	ON 2-3 5-6 8-9	NONE	(ON) 2-1 5-4 8-7	15A	6A	20A	8A	25°			
S38		3PDT	(ON) 2-3 5-6 8-9	OFF	(ON) 2-1 5-4 8-7	15A	6A	15A	8A	25°			
S39		3PDT	ON 2-3 5-6 8-9	OFF	(ON) 2-1 5-4 8-7	15A	6A	15A	8A	25°			



• Standard Hardware: AT503M Face Hex Nut, AT506 Locking Ring, AT508 Lockwasher, AT527M Backup Hex Nut. See Accessories & Hardware section.

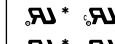

FOUR POLE WITH SOLDER LUG

*See Supplement section for UL detail			Toggle Position/Connected Terminals () = Momentary						Electrical Capacity				α = Angle of Throw
Model Suffix R = Flatted Lever	Approvals	Pole & Throw	Down 	Center 	Up 	Resistive			Inductive				
						AC 125V	AC 250V	DC 30V	AC 125V PF 0.6				
S41/S41R		4PST	ON 1-3 4-6 7-9 10-12	NONE	OFF —	25A	9A	20A	10A	25°			
S42/S42R		4PDT	ON 2-3 5-6 8-9 11-12	NONE	ON 2-1 5-4 8-7 11-10	25A	9A	20A	10A	25°			
S43/S43R		4PDT	ON 2-3 5-6 8-9 11-12	OFF	ON 2-1 5-4 8-7 11-10	25A	9A	20A	10A	30°			
S45	—	4PDT	ON 2-3 5-6 8-9 11-12	NONE	(ON) 2-1 5-4 8-7 11-10	15A	6A	20A	8A	25°			
S48/S48R		4PDT	(ON) 2-3 5-6 8-9 11-12	OFF	(ON) 2-1 5-4 8-7 11-10	15A	6A	20A	8A	25°			
S49/S49R		4PDT	ON 2-3 5-6 8-9 11-12	OFF	(ON) 2-1 5-4 8-7 11-10	15A	6A	20A	8A	25°			





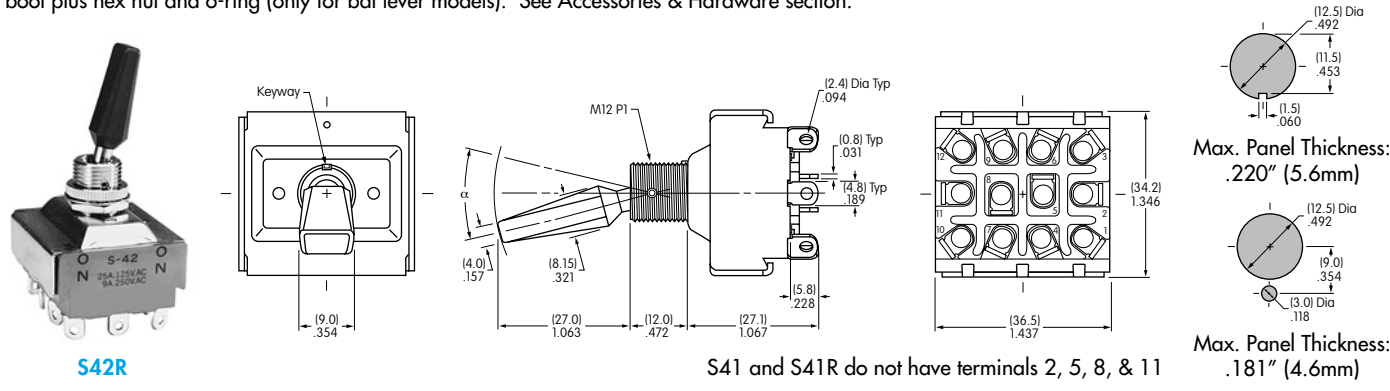





• Standard Hardware for **Bat Lever**: AT503M Face Hex Nut, AT506 Locking Ring, AT508 Lockwasher, AT527M Backup Hex Nut; for **Flatted Lever (R)**: AT504M Knurled Face Nut, AT508 Lockwasher, AT527M Backup Hex Nut. See Accessories & Hardware section. • Optional Splashproof Boot Assembly: AT4181 boot plus hex nut and o-ring (only for bat lever models). See Accessories & Hardware section.



THREE POLE WITH SCREW LUG

*See Supplement section for CSA detail

Model	Approvals	Pole & Throw	Toggle Position/Connected Terminals			Electrical Capacity					α = Angle of Throw
			Down 	Center 	Up 	Resistive			Inductive		
						AC 125V	AC 250V	DC 30V	AC 125V PF 0.6	AC 250V PF 0.6	
S31T	—   *	3PST	ON 1-3 4-6 7-9	NONE	OFF —	25A	9A	20A	10A	5A	25°
S32T	—   *	3PDT	ON 2-3 5-6 8-9	NONE	ON 2-1 5-4 8-7	25A	9A	20A	10A	5A	25°
S33T	—   *	3PDT	ON 2-3 5-6 8-9	OFF	ON 2-1 5-4 8-7	25A	9A	20A	10A	5A	30°

Throw & Schematics:

3PST:  INTERNAL CONNECTION

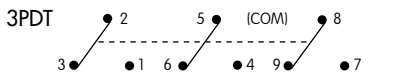
3PDT:  (COM) 8

Note: Terminal numbers are on the switch

• Standard Hardware: AT503M Face Hex Nut, AT506 Locking Ring, AT508 Lockwasher, AT527M Backup Hex Nut. See Accessories & Hardware section.

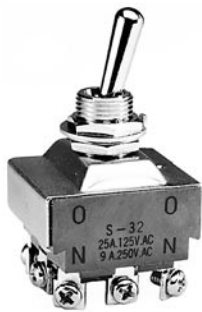

S32T

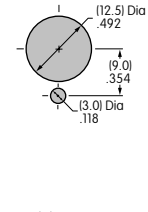
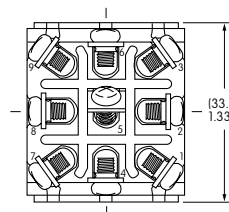
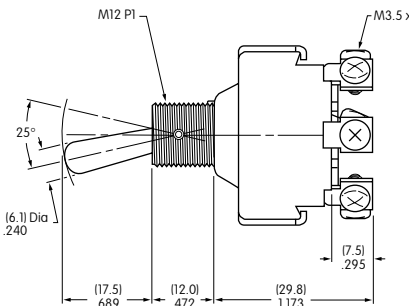
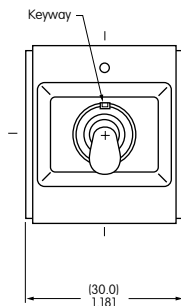







Maximum Panel Thickness: .181" (4.6mm)

S31T does not have terminals 2, 5, & 8

FOUR POLE WITH SCREW LUG

*See Supplement section for CSA detail

Model	Approvals	Pole & Throw	Toggle Position/Connected Terminals			Electrical Capacity					α = Angle of Throw
			Down 	Center 	Up 	Resistive			Inductive		
						AC 125V	AC 250V	DC 30V	AC 125V PF 0.6	AC 250V PF 0.6	
S41T	—  *	4PST	ON 1-3 4-6 7-9 10-12	NONE	OFF —	25A	9A	20A	10A	5A	25°
S42T	—  *	4PDT	ON 2-3 5-6 8-9 11-12	NONE	ON 2-1 5-4 8-7 11-10	25A	9A	20A	10A	5A	25°
S43T	—  *	4PDT	ON 2-3 5-6 8-9 11-12	OFF	ON 2-1 5-4 8-7 11-10	25A	9A	20A	10A	5A	30°

Throw & Schematics:

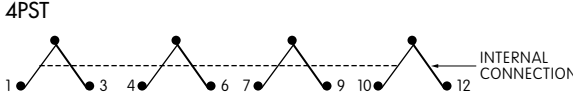
4PST:  INTERNAL CONNECTION

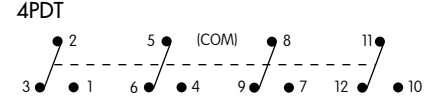
4PDT:  (COM) 8

Note: Terminal numbers are on the switch

• Standard Hardware: AT503M Face Hex Nut, AT506 Locking Ring, AT508 Lockwasher, AT527M Backup Hex Nut. See Accessories & Hardware section.





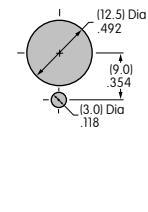
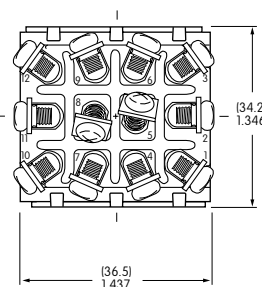
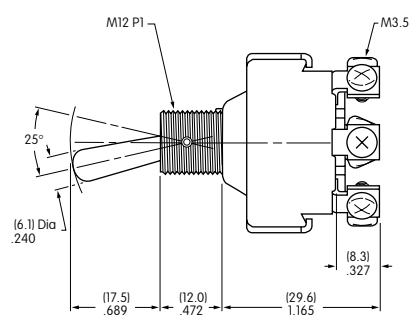
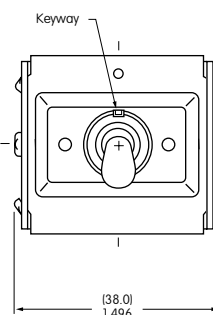



S42T



Maximum Panel Thickness: .181" (4.6mm)

S41T does not have terminals 2, 5, 8, & 11

THREE POLE WITH QUICK CONNECT

*See Supplement section for UL detail			Toggle Position/Connected Terminals			Electrical Capacity				$\alpha =$ Angle of Throw
Model	Approvals	Pole & Throw	Down	Center	Up	Resistive			Inductive	
			Keyway 			AC 125V	AC 250V	DC 30V	AC 125V PF 0.6	
S31F		3PST	ON 1-3 4-6 7-9	NONE	OFF —	25A	9A	20A	10A	25°
S32F		3PDT	ON 2-3 5-6 8-9	NONE	ON 2-1 5-4 8-7	25A	9A	20A	10A	25°
S33F		3PDT	ON 2-3 5-6 8-9	OFF	ON 2-1 5-4 8-7	25A	9A	20A	10A	30°

Throw & Schematics:



Note: Terminal numbers are on the switch

• Standard Hardware: AT503M Face Hex Nut, AT506 Locking Ring, AT508 Lockwasher, AT527M Backup Hex Nut. See Accessories & Hardware section.





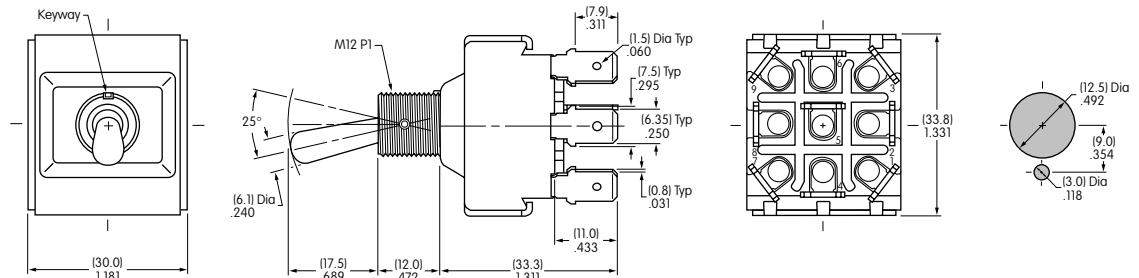



S32F



S31F does not have terminals 2, 5, & 8

Maximum Panel Thickness: .181" (4.6mm)

FOUR POLE WITH QUICK CONNECT

*See Supplement section for UL detail			Toggle Position/Connected Terminals			Electrical Capacity				$\alpha =$ Angle of Throw
Model	Approvals	Pole & Throw	Down	Center	Up	Resistive			Inductive	
			Keyway 			AC 125V	AC 250V	DC 30V	AC 125V PF 0.6	
S41F		4PST	ON 1-3 4-6 7-9 10-12	NONE	OFF —	25A	9A	20A	10A	25°
S42F		4PDT	ON 2-3 5-6 8-9 11-12	NONE	ON 2-1 5-4 8-7 11-10	25A	9A	20A	10A	25°
S43F		4PDT	ON 2-3 5-6 8-9 11-12	OFF	ON 2-1 5-4 8-7 11-10	25A	9A	20A	10A	30°

Throw & Schematics:



Note: Terminal numbers are on the switch

• Standard Hardware: AT503M Face Hex Nut, AT506 Locking Ring, AT508 Lockwasher, AT527M Backup Hex Nut. See Accessories & Hardware section.



S42F

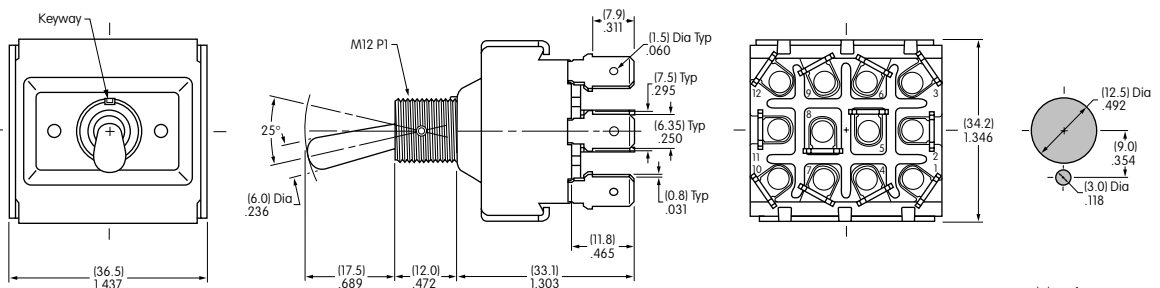

S41F does not have terminals 2, 5, 8, & 11

Maximum Panel Thickness: .181" (4.6mm)

GENERAL SPECIFICATIONS FOR S421 ~ S429

Electrical Capacity (Resistive & Inductive Load)

Power Level: Shown in the following tables

Other Ratings

- Contact Resistance:** 10 milliohms maximum
- Insulation Resistance:** 1,000 megohms minimum @ 500V DC
- Dielectric Strength:** 2,000V AC minimum for 1 minute minimum
- Mechanical Life:** 50,000 operations minimum for all other models
- Electrical Life:** 15,000 operations minimum
- Angle of Throw (α):** Shown in tables on following pages

Materials & Finishes

- Toggle:** Brass with chrome plating
- Bushing:** Brass with chrome plating
- Case:** Melamine phenol
- Case Cover:** Steel with chromate plating over zinc plating
- Movable Contactor:** Copper with silver plating
- Movable Contacts:** Silver alloy capped on copper with silver plating
- Stationary Contacts:** Silver alloy capped on copper with silver plating
- Terminals:** Brass with silver plating



Environmental Data

Operating Temp Range: -10°C through +70°C (+14°F through +158°F)

Installation

- Mounting Torque:** 2.94Nm (26 lb•in) for double nut
- Maximum Panel Thickness:** Shown beneath panel cutout in switch dimension drawings
- Soldering Time & Temperature:** Manual Soldering: See Profile A in Supplement section.

DOUBLE POLE WITH SOLDER LUG

Model	Approvals	Pole & Throw	Toggle Position/Connected Terminals () = Momentary					Electrical Capacity				Motor Load AC 125V	α = Angle of Throw
			Down 	Center 	Up 	Resistive		Inductive					
						AC 125V	AC 250V	PF 0.75 - 0.8					
S421	— —	DPST	ON 1-3 4-6	NONE	OFF —	25A	25A	25A	25A	750W	24°		
S422	— —	DPDT	ON 2-3 5-6	NONE	ON 2-1 5-4	25A	25A	25A	25A	750W	24°		
S423	— —	DPDT	ON 2-3 5-6	OFF	ON 2-1 5-4	25A	25A	25A	25A	750W	28°		
S425	— —	DPDT	ON 2-3 5-6	NONE	(ON) 2-1 5-4	15A	15A	15A	15A	400W	24°		
S428	— —	DPDT	(ON) 2-3 5-6	OFF	(ON) 2-1 5-4	15A	15A	15A	15A	400W	24°		
S429	— —	DPDT	ON 2-3 5-6	OFF	(ON) 2-1 5-4	15A	15A	15A	15A	400W	24°		

Throw & Schematics:

DPST



DPDT

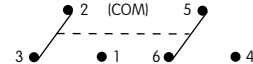

Note: Terminal numbers are on the switch

- Standard Hardware: AT503M Face Hex Nut, AT506 Locking Ring, AT508 Lockwasher, AT527M Backup Hex Nut. See Accessories & Hardware section.



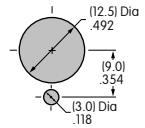
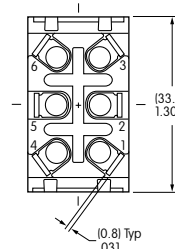
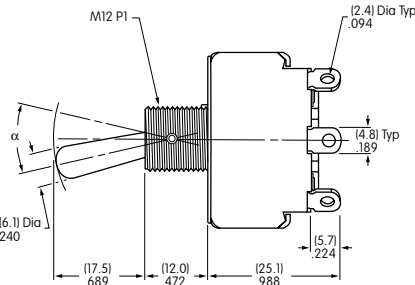
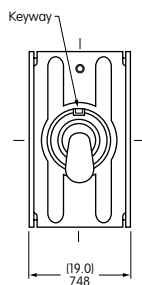

S422



Maximum Panel Thickness: .185" (4.7mm)

S421 does not have terminals 2 & 5

DOUBLE POLE WITH SCREW LUG

Model	Approvals	Pole & Throw	Toggle Position/Connected Terminals () = Momentary					Electrical Capacity				Motor Load AC 125V	α = Angle of Throw
			Down 	Center 	Up 	Resistive		Inductive					
						AC 125V	AC 250V	PF 0.75 - 0.8					
S421T	— —	DPST	ON 1-3 4-6	NONE	OFF —	20A	20A	20A	20A	750W	24°		
S422T	— —	DPDT	ON 2-3 5-6	NONE	ON 2-1 5-4	20A	20A	20A	20A	750W	24°		
S423T	— —	DPDT	ON 2-3 5-6	OFF	ON 2-1 5-4	20A	20A	20A	20A	750W	28°		
S425T	— —	DPDT	ON 2-3 5-6	NONE	(ON) 2-1 5-4	15A	15A	15A	15A	400W	24°		
S428T	— —	DPDT	(ON) 2-3 5-6	OFF	(ON) 2-1 5-4	15A	15A	15A	15A	400W	24°		
S429T	— —	DPDT	ON 2-3 5-6	OFF	(ON) 2-1 5-4	15A	15A	15A	15A	400W	24°		

Throw & Schematics:

DPST



DPDT

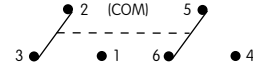

Note: Terminal numbers are on the switch

- Standard Hardware: AT503M Face Hex Nut, AT506 Locking Ring, AT508 Lockwasher, AT527M Backup Hex Nut. See Accessories & Hardware section.



S423T

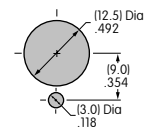
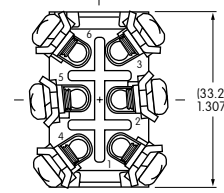
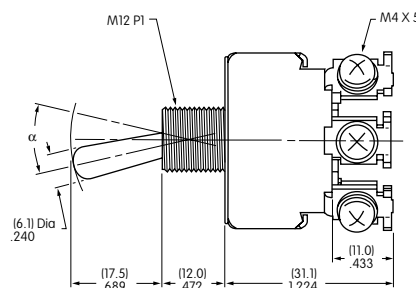
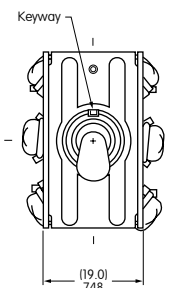

Maximum Panel Thickness: .185" (4.7mm)

S421T does not have terminals 2 & 5