

Technical Data Sheet

3mm POWER LED

31-01/B4C-AKNB

Features

- . High Flux Output.
- . Low Profile.
- . Low Thermal Resistance.
- . Low Power Consumption.
- . The product itself will remain within RoHS compliant version.
- . ESD-withstand voltage: up to 4KV.



Descriptions

This revolutionary package design allows the light designer to reduce the number of LEDs required and provide a more uniform and unique illuminated appearance than with other LED solutions. This is possible through the efficient optical package design and high-current capabilities.

The low profile package can be easily coupled with reflectors or lenses to efficiently distribute light and provide the desired light appearance.

Applications

- . Automotive Exterior Lighting
- . Electronic Signs and Signals
- . Channel Letter
- . Special Lighting application

Device Selection Guide

PART NO.	Chip		Lens Color
	Material	Emitted Color	
31-01/B4C-AKNB	InGaN	Blue	Water Clear



Technical Data Sheet

3mm POWER LED

31-01/B4C-AKNB

Package Dimensions

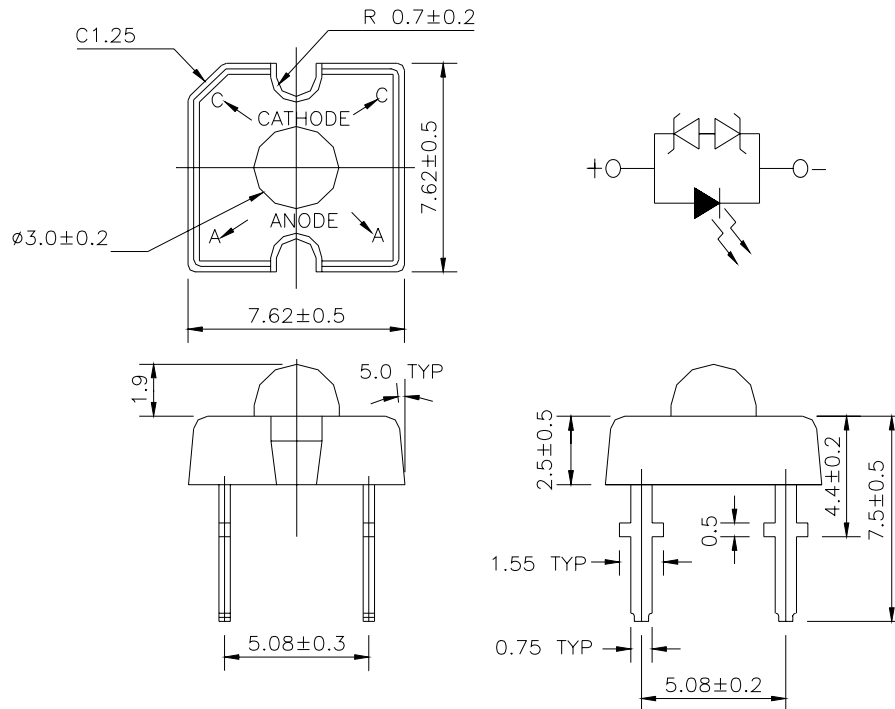

- Notes:**
1. All dimensions are in millimeters
 2. An epoxy meniscus may extend about 1.5mm(0.059") down the leads
 3. Tolerances unless dimensions ± 0.25 mm

Absolute Maximum Ratings (Ta=25°C)

Parameter	Symbol	Rating	Units
Continuous Forward Current	I_F	30	mA
Peak Forward Current(Duty 1/10 @ 1KHZ)	I_{FP}	100	mA
Reverse Voltage	V_R	5	V
Operating Temperature	T_{opr}	-40 ~ +85	°C
Storage Temperature	T_{stg}	-40 ~ +100	°C
Soldering Temperature(T=5 sec)	T_{sol}	260 ± 5	°C
Power Dissipation	P_d	100	mW
Zener Reverse Current	I_Z	100	mA
Electrostatic Discharge	ESD	4K	V



Technical Data Sheet

3mm POWER LED

31-01/B4C-AKNB

Electro-Optical Characteristics (Ta=25°C)

Parameter	Symbol	Min.	Typ.	Max.	Condition	Unit
Total Flux	Φ_v	1125	1800	2850	I _F =30mA	mlm
Viewing Angle	$2\theta_{1/2}$	----	50	----	I _F =30mA	deg
Peak Wavelength	λ_p	----	468	----	I _F =30mA	Nm
Dominant Wavelength	λ_d	464	470	476	I _F =30mA	Nm
Spectrum Radiation Bandwidth	$\Delta\lambda$	----	35	----	I _F =30mA	nm
Forward Voltage	V _F	3.0	3.5	4.0	I _F =30mA	V
Reverse Current	I _R	----	----	10	V _R =5V	uA
Zener Reverse Voltage	V _Z	5.2	----	----	I _Z =5mA	V

Rank

31-01/B4C-AKNB

(1)

(2)

(3)

(1) V _F (V)			(2) λ_d			(3) Φ_v (mlm)		
Bin.	Min.	Max.	Bin.	Min.	Max.	Bin.	Min.	Max.
1	3.00	3.20	3	464	468	K	1125	1425
2	3.20	3.40	4	468	472	L	1425	1800
3	3.40	3.60	5	472	476	M	1800	2250
4	3.60	3.80				N	2250	2850
5	3.80	4.00						

*Measurement Uncertainty of Forward Voltage : ±0.1V

*Measurement Uncertainty of Luminous Intensity: ±15%

*Measurement Uncertainty of Dominant Wavelength ±1.0nm



Technical Data Sheet

3mm POWER LED

31-01/B4C-AKNB

Typical Electro-Optical Characteristics Curves

Relative Intensity vs. Wavelength

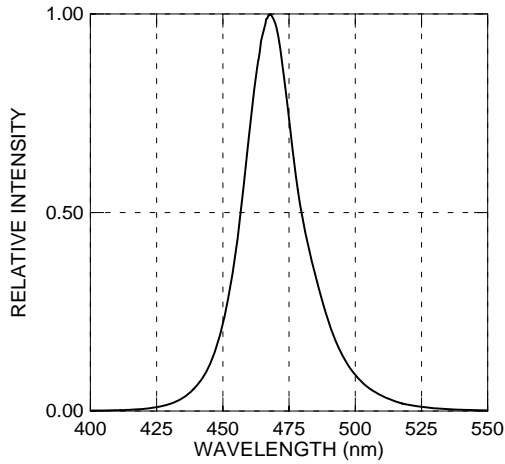

Forward Current vs. Forward Voltage

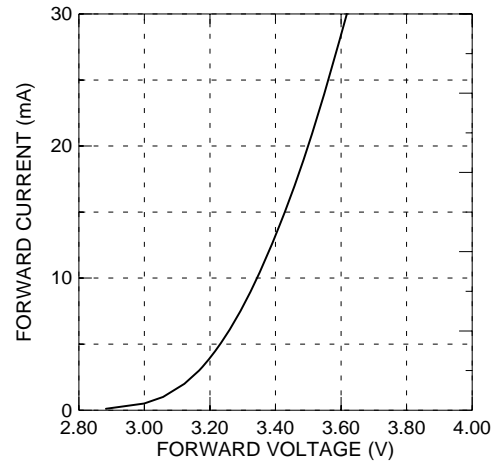

Relative Intensity vs. Forward Current

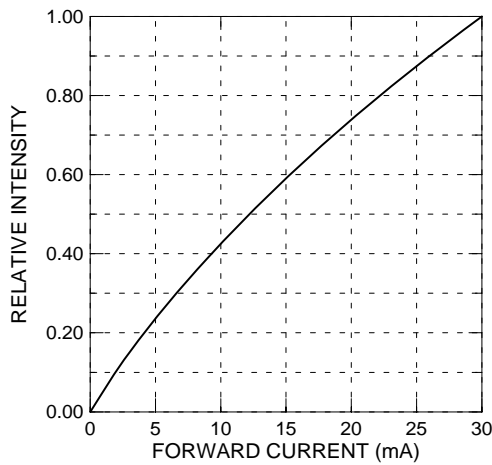

Forward Current vs. Ambient Temp.

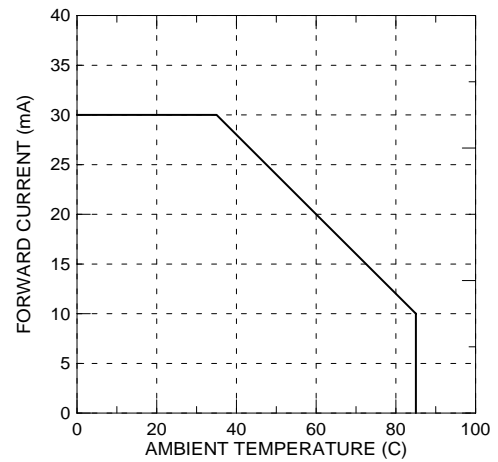

Relative Intensity vs. Displacement Angle

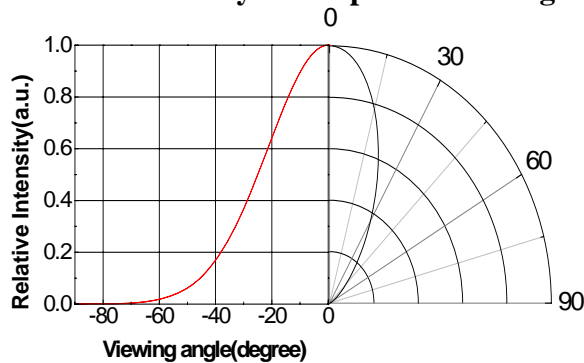



Technical Data Sheet

3mm POWER LED

31-01/B4C-AKNB

Packing Quantity Specification

- (1) 60 pcs/1 tube, 30 tubes/1 small inside box, 12 small inside boxes/1 outside box
- (2) 60 pcs/1 tube, 105 tubes/1 big inside box, 4 big inside boxes/1 outside box

Label Form Specification

(1) Tube Label Form

	PART NO: 31-01/B4C-AKNB	QTY: 60
	LOT NO:	CAT:

(2) Box Label Form

CPN:	
P/N:	
	RoHS
31-01/B4C-AKNB	
QTY :	CAT:
	HUE:
LOT NO :	REF:
MADE IN TAIWAN	

PART NO: Everlight's Production Number

QTY: Packing Quantity

LOT NO: Lot Number

CAT: Ranks of Forward Voltage, Dominant Wavelength and Total Flux

CPN: Customer's Production Number

P/N : Production Number

HUE: Reference

REF: Reference

MADE IN TAIWAN: Production Place

Technical Data Sheet

3mm POWER LED

31-01/B4C-AKNB

Notes

1. Above specification may be changed without notice. EVERLIGHT will reserve authority on material change for above specification.
2. When using this product, please observe the absolute maximum ratings and the instructions for using outlined in these specification sheets. EVERLIGHT assumes no responsibility for any damage resulting from use of the product which does not comply with the absolute maximum ratings and the instructions included in these specification sheets.
3. These specification sheets include materials protected under copyright of EVERLIGHT corporation. Please don't reproduce or cause anyone to reproduce them without EVERLIGHT's consent.
4. Below the zener reference voltage V_z , all the current flows through LED and as the voltage rises to V_z , the zener diode "breakdown." If the voltage tries to rise above V_z current flows through the zener branch to keep the voltage at exactly V_z .
5. When the LED is connected using serial circuit, if either piece of LED is no light up but current can't flow through causing others to light down. In new design, the LED is parallel with zener diode. if either piece of LED is no light up but current can flow through causing others to light.

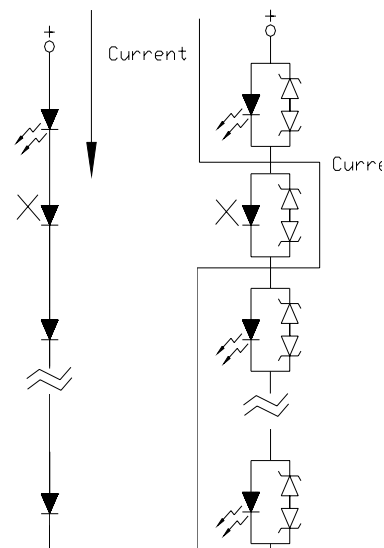



Technical Data Sheet

3mm POWER LED

31-01/B4C-AKNB

6. Soldering Condition

Careful attention should be paid during soldering. When soldering, leave more than 3mm from solder joint to case, and soldering beyond the base of the tie bar is recommended.

Avoiding applying any stress to the lead frame while the LEDs are at high temperature particularly when soldering.

Recommended soldering conditions:

Hand Soldering		DIP Soldering	
Temp. at tip of iron	400°C Max. (30W Max.)	Preheat temp.	100°C Max. (60 sec Max.)
Soldering time	3 sec Max.	Bath temp.	265 Max.
Distance	3mm Min.(From solder joint to case)	Bath time.	5 sec Max.
		Distance	3mm Min.

EVERLIGHT ELECTRONICS CO., LTD.
Office: No 25, Lane 76, Sec 3, Chung Yang Rd,
Tucheng, Taipei 236, Taiwan, R.O.C

Tel: 886-2-2267-2000, 2267-9936
Fax: 886-2267-6244, 2267-6189, 2267-6306
<http://www.everlight.com>