

# ASSP

## ISO/IEC 15693 Compliant FRAM Embedded High-speed RFID LSI FerVID family™

# MB89R118

### ■ DESCRIPTION

The MB89R118 is an LSI device that has built-in high-speed, large-capacity FRAM and is used for vicinity-RFID.

### ■ FEATURES

- Memory capacity of 2 Kbytes FRAM (including 2,000 bytes of user area)
- 8-byte/block configuration, 256 blocks
- High-speed data transmission and reception at 26.48 kbps
- Fast command supported (data transmission at 52.97 kbps) (Transponder → Reader/Writer)
- Carrier frequency at 13.56 MHz
- Anti-collision function : 30 tags per second
- Endurance :  $10^{10}$  writes to memory
- Data Retention : 10 years ( $T_a = 0\text{ }^{\circ}\text{C}$  to  $+55\text{ }^{\circ}\text{C}$ )
- 64-bit UID
- FRAM memory data protection
- Anti-theft (EAS) command
- Compliance with ISO/IEC 15693 (partly not supported\*)
- Compliance with ISO/IEC 18000-3 (Mode 1) (partly not supported\*)

\* : Refer to "■ NOTES ON USING".

FerVID family is a trademark of Fujitsu Microelectronics Limited, Japan.

# MB89R118

## ■ BLOCK DIAGRAM

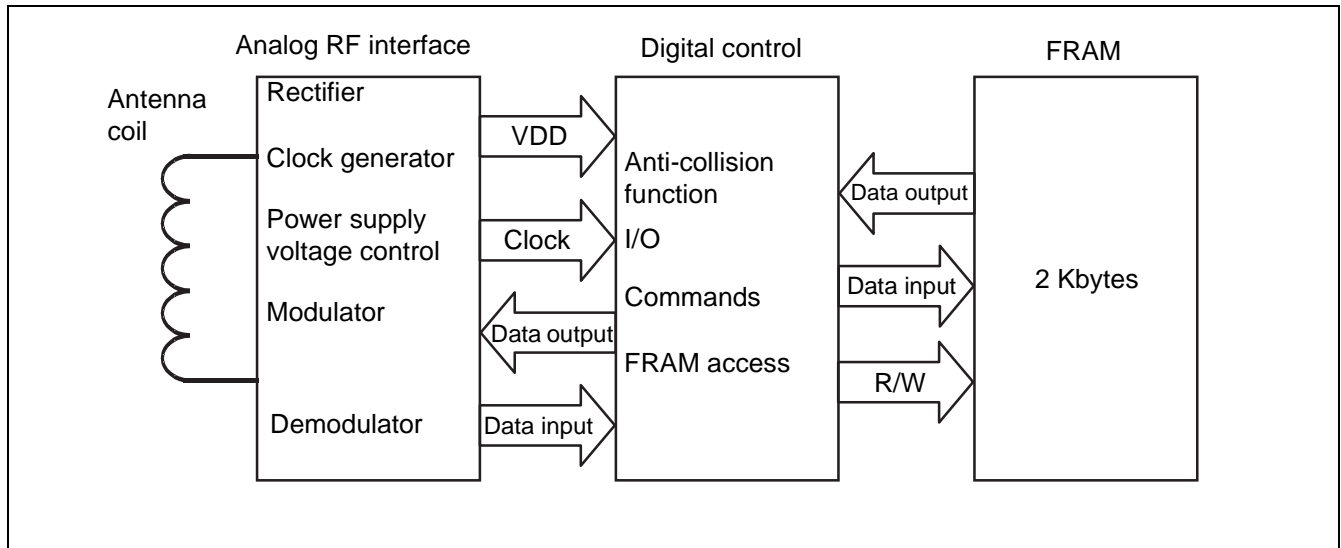

## ■ MEMORY MAP

This section describes the FRAM memory, which is the internal memory of the MB89R118.

### • FRAM Configuration

The FRAM has 2,000 bytes for use as user area and 48 bytes for use as system area.

The FRAM memory areas consist of a total of 256 blocks (250 blocks of user area and 6 blocks of system area).

Each block can store 64 bits (8 bytes) of data.

The block is the unit used for the writing and reading of FRAM data. The memory configuration of FRAM is shown below.

### • FRAM memory configuration

Area	Block No.	Details	Data read	Data write
User area (2000 bytes)	00 <sub>H</sub> to F9 <sub>H</sub>	User area	Yes	Yes
System area (48 bytes)	FA <sub>H</sub>	UID (64 bits)	Yes	No
	FB <sub>H</sub>	AFI, DSFID, EAS, security status	Yes	Limited
	FC <sub>H</sub> to FF <sub>H</sub>	Block security status	Yes	No

Blocks “00<sub>H</sub>” to “F9<sub>H</sub>” are user area. The user area is defined as an area that can be accessed when the corresponding block address is specified. On the other hand, Blocks “FA<sub>H</sub>” to “FF<sub>H</sub>” are system area. The system area is defined as an area that can be accessed only with a specific command.

The system area consists of 6 blocks and contains UID, AFI, DSFID, EAS bits, and security status (can write or cannot write) data for individual block. UID is fixed and cannot be updated. AFI, DSFID, and EAS bits are written at the factory, and can be updated and locked (disable to write) with commands (Only EAS bit cannot be locked) .

As shown in above, “FA<sub>H</sub>” holds the UID, and “FC<sub>H</sub>” to “FF<sub>H</sub>” hold the security status information on individual user areas.

The configuration of “FB<sub>H</sub>” to “FF<sub>H</sub>” blocks is shown below. “FB<sub>H</sub>” block is used for EAS status, AFI and DSFID data, the security status data of AFI and DSFID. “FC<sub>H</sub>” to “FF<sub>H</sub>” blocks contain block security status data.

### • Structure of “FB<sub>H</sub>”

MSB				LSB							
64	57	56	33	32	25	24	17	16	9	8	1
EAS Status		RFU*			DSFID Lock Status	AFI Lock Status		DSFID		AFI	

\* : Reserved for future use

# MB89R118

- Structure of “FC<sub>H</sub>” to “FF<sub>H</sub>”

Block security status (BSS) of user block 3F<sub>H</sub>

Block security status (BSS) of user block 00<sub>H</sub>

	MSB												LSB
FC <sub>H</sub>	3F	3E	3D	3C	3B	3A	39	-----	03	02	01	00	
FD <sub>H</sub>	7F	7E	7D	7C	7B	7A	79	-----	43	42	41	40	
FE <sub>H</sub>	BF	BE	BD	BC	BB	BA	B9	-----	83	82	81	80	
FF <sub>H</sub>	RFU* (6 bits)						F9	-----	C3	C2	C1	C0	

\* : Reserved for future use

The security status of the user area is stored in the block security status bit in system area blocks of “FC<sub>H</sub>” to “FF<sub>H</sub>” per bit in each block. A user area is unlocked when the corresponding block security status bit is “0”; it is locked (disable to write state) when the corresponding block security status bit is “1”.

EAS bit is a single bit, and it is used for setting EAS status. It is possible to read/write data of 2 blocks at one time in the user area (If Read Multiple Blocks Unlimited command is used, up to 256 blocks can be accessed at one time) .

## ■ DATA ELEMENT DEFINITION

### 1. Unique Identifier (UID)

The MB89R118 has a 64-bit unique identifier (UID) that complies with ISO/IEC 15693-3. The UID is used to distinguish a transponder from another transponder in the anti-collision algorithm described later.

The UID consists of the 3 items shown in the following.

- An 8-bit data whose value is always “E0<sub>H</sub>” (bit 57 to bit 64)
- An 8-bit IC manufacturer code whose value is always “08<sub>H</sub>”, and is defined by ISO/IEC 7816-6/AMI (bit 49 to bit 56)
- Unique 48-bit serial number assigned by Fujitsu Microelectronics (bit 1 to bit 48)

Among the unique 48-bit serial number assigned by Fujitsu Microelectronics, the 1 byte from bit 41 to bit 48 defines MB89R118 code whose value is “01<sub>H</sub>”. And the 5 bytes from bit 1 to bit 40 define Chip Information.

#### • Structure of UID

MSB				LSB			
64	57	56	49	48	41	40	1
“E0 <sub>H</sub> ”		IC manufacturer code “08 <sub>H</sub> ”		“01 <sub>H</sub> ”		Chip information	
Unique serial number assigned by Fujitsu Microelectronics							

## 2. Application Family Identifier (AFI)

The application family identifier (AFI) identifies the type of application set by the transponder.

The AFI can be written with a command. The AFI is 8-bit data and is stored in the system area of FRAM.

The factory default setting of the AFI is "00H".

### • Types of AFI

Application Family (bit 8 to bit 5)	Application Sub-Family (bit 4 to bit 1)	Application Use Field	Example/Note
"0"	"0"	All families and sub-families	No application preselection
X	"0"	All sub-families of family X	Wide applicative preselection
X	Y	Only the Yth sub-families of family X	
"0"	Y	All families of Yth sub-families	
"1"	"0", Y	Transport	Mass transit, bus, airline
"2"	"0", Y	Financial	IEP, banking, retail
"3"	"0", Y	Identification	Access control
"4"	"0", Y	Telecommunication	Public telephone, GSM
"5"	"0", Y	Medical	
"6"	"0", Y	Multimedia	Internet services
"7"	"0", Y	Gaming	
"8"	"0", Y	Data storage	Portable files
"9"	"0", Y	EAN-UCC system for application identifiers	Managed by ISO/IEC JTC1/SC31
"A"	"0", Y	ISO/IEC JTC1/SC31	Data identifiers as defined in ISO/IEC15418
"B"	"0", Y	IATA	Managed by ISO/IEC JTC1/SC31
"C"	"0", Y	UPU	Managed by ISO/IEC JTC1/SC31
"D"	"0", Y	RFU*	Managed by ISO/IEC JTC1/SC31
"E"	"0", Y	RFU*	Managed by ISO/IEC JTC1/SC31
"F"	"0", Y	RFU*	Managed by ISO/IEC JTC1/SC31

\* : Reserved for future use

Note : Both X value and Y value are "1" to "F".

In the status of the AFI\_flag setting;

- If the AFI is not supported by the transponder, no response to all requests is returned.
- If the AFI is supported by the transponder, the response is returned only if the value is in accord with the AFIsent from a reader/writer.

## 3. Data Storage Format Identifier (DSFID)

The data storage format identifier (DSFID) indicates how data is structured in the transponder (LSI memory device). The DSFID can be programmed with a command.

The DSFID is 8-bit data and is stored in the system area of FRAM. The factory default setting of the DSFID is "01H".

## 4. Cyclic Redundancy Check (CRC)

When a frame is received, reception of correct data--that is, the characters making up the frame is assumed only when the value of the cyclic redundancy check (CRC) code is valid. For error-checking purposes, a 2-byte CRC code value is inserted between data and the EOF signal.

The value of CRC code is required from all the data contained between the SOF and CRC field in each frame. Method of calculation is provided in ISO/IEC 13239. The details are provided in ISO/IEC 15693-3 and ISO/IEC 18000-3 (Mode 1) . The initial value of the CRC code provided in ISO/IEC 15693-3 is "FFFF<sub>H</sub>".

The CRC code is transferred, beginning with the lowest-order bit in the lowest-order byte.

- CRC bit/byte transition order

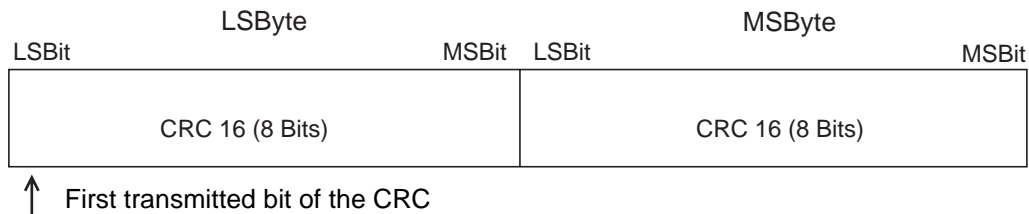

## 5. Electronic Article Surveillance (EAS) status

EAS status is 1 bit data (LSB side) , which is stored in the system area of FRAM. The initial value is "1". EAS bit "1" means goods-monitoring status, and EAS bit "0" means that goods-monitoring status is cleared. EAS status can be written by Write EAS command and can be checked "FB<sub>H</sub>" block (refer to "■ MEMORY MAP") by Read commands such as Read Single Block command.

Together with Gate type reader/writer, EAS command can support anti-theft security functions.

## ■ FUNCTION DESCRIPTION

### 1. Communication from Reader/Writer to Transponder

#### (1) Modulation method

The MB89R118 supports only 10% ASK modulation (Not supports 100% ASK modulation) .

Modulation rate  $m$  is defined as  $m = (a - b)/(a + b)$  with reference to the modulated waveform shown below. The values  $a$  and  $b$  indicate, respectively, the maximum and minimum amplitude of magnetic field transmitted from a reader/writer.

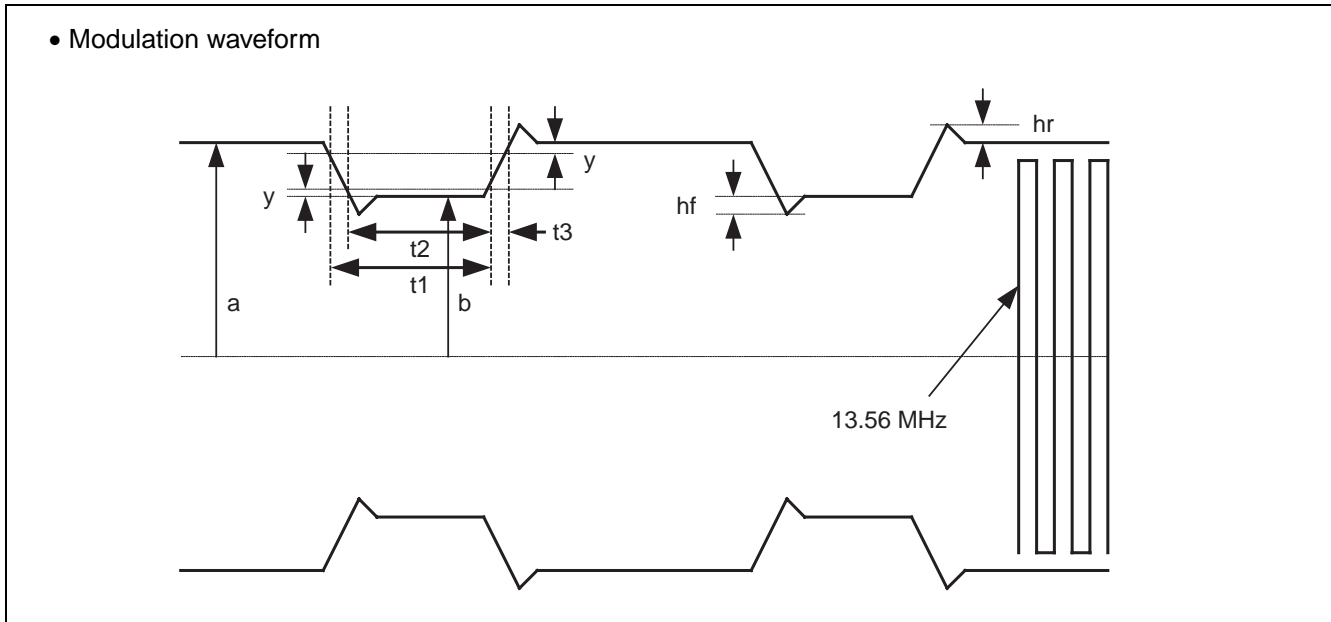

Maximum and minimum values of  $t_1$ ,  $t_2$  and  $t_3$  are shown in the following table. In this table,  $y$  is  $0.05(a-b)$  and the maximum value of  $hf$  and  $hr$  is  $0.1(a-b)$ .



## (2) Data rate and data coding

The MB89R118 supports only 1 out of 4 mode for bit coding (Not supports 1 out of 256 mode). In 1 out of 4 mode, 2-bit signals are coded in a period of 75.52  $\mu\text{s}$  as shown in the following. When coding takes place, the data rate is 26.48 kbps ( $f_c/512$ ). Each signal is transmitted beginning with the lowest bit.

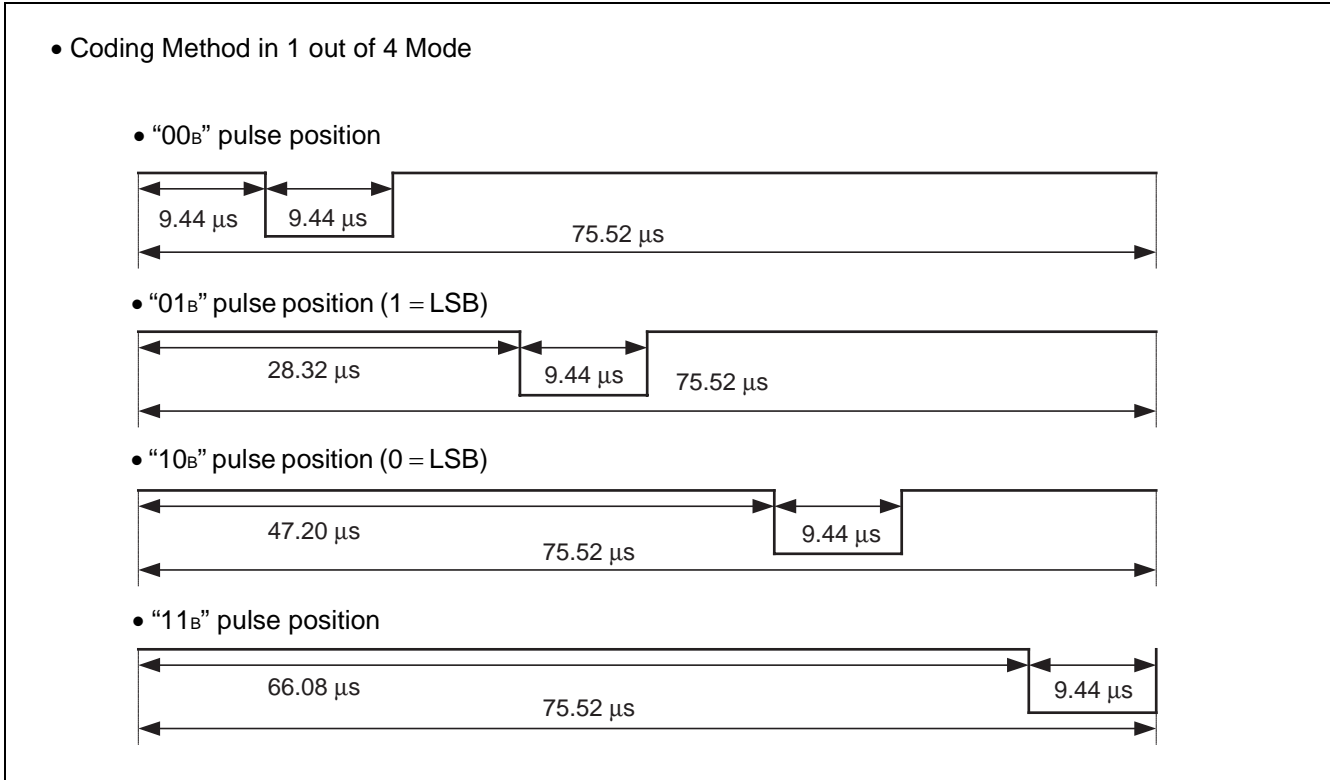

## (3) Data frame

A data frame begins with a start of frame (SOF) signal and ends with an end of frame (EOF) signal. The MB89R118 is enabled to receive a frame from a reader/writer within 300  $\mu\text{s}$  after the MB89R118 has sent a frame to the reader/writer. The MB89R118 is also enabled to receive a frame from a reader/writer within 3 ms after power has been supplied to the MB89R118.

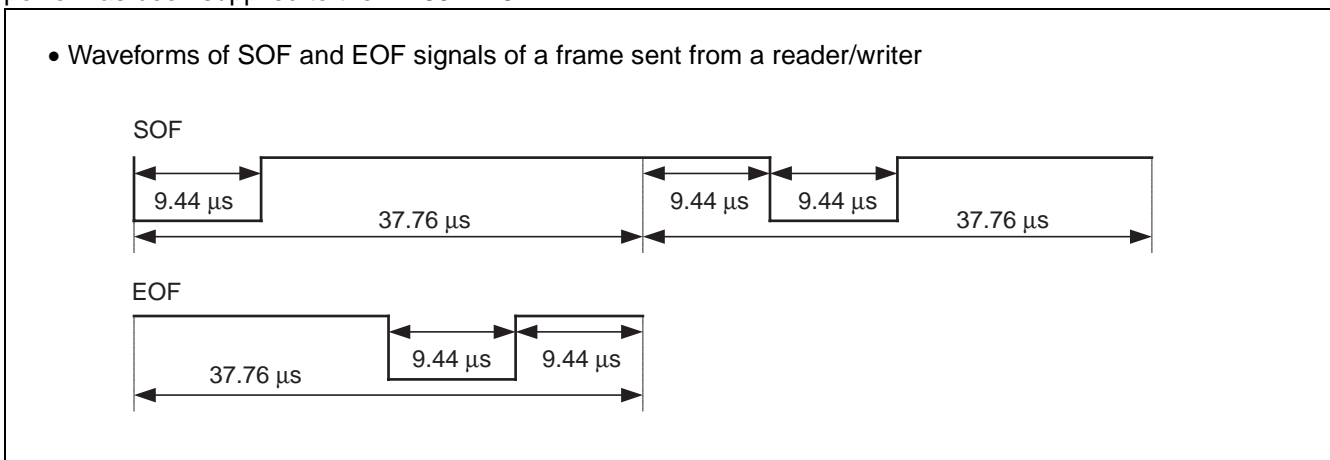

# MB89R118

## 2. Communication from Transponder to Reader/Writer

- Minimum load modulation amplitude (V<sub>lm</sub>) : 10 mV (based on ISO/IEC 10373-7)
- Load modulation subcarrier frequency (f<sub>s</sub>) : 423.75 kHz(f<sub>c</sub>/32)

The MB89R118 supports only a 1-subcarrier system.  
(Not supports 2-subcarrier system.)

- Data rate : The MB89R118 supports the following 2 data rate modes :
  - Low data rate
  - High data rate

One of the 2 data rate modes is specified by the Data\_rate\_flag (described later) sent from the reader/writer. In low data rate mode, the data rate is 6.62 kbps (f<sub>c</sub>/2048); in high data rate mode, it is 26.48 kbps (f<sub>c</sub>/512).

When receiving the Fast commands (Custom commands) , the communication starts from the transponder in the data rate that is twice as fast as normal data rate. In this case, the 2 data rate modes of low data rate and high data rate specified by the Data\_rate\_flag is supported. In Low data rate mode, the data rate is 13.24 kbps (f<sub>c</sub>/1024) ; in high data rate mode, it is 52.97 kbps (f<sub>c</sub>/256) .

### (1) Bit coding

The Manchester coding is used for the bit coding. The following figures show the signals modulated in high data rate mode when ISO command is received and the same signals when fast command is received. In low data rate mode of both ISO commands and fast commands, the number of pulses for subcarrier and data transfer time are 4 times as large as the number in high data rate mode.

- Signal waveforms by load modulation in high data rate mode (ISO commands)

- Logic 0

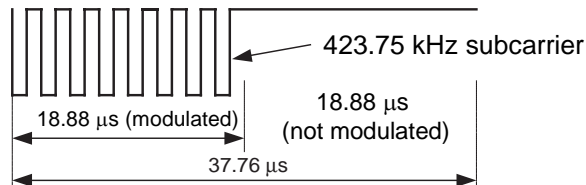

- Logic 1

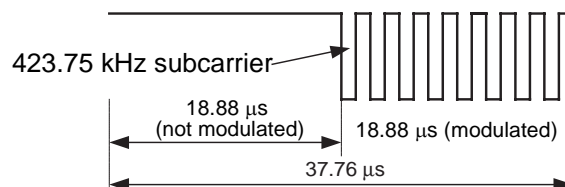

- Signal waveforms by load modulation in high data rate response mode (fast commands)

- Logic 0

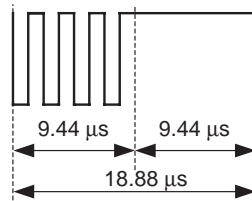

- Logic 1

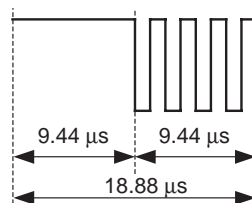

## (2) Data frame

A data frame sent from a transponder starts with a start of frame (SOF) signal and ends with an end of frame (EOF) signal. The following figures show the SOF and EOF signals sent in high data rate mode when ISO command is received and the same signals when fast command is received. In low data rate mode of both ISO commands and fast commands, the number of pulses in subcarrier and data transfer time are 4 times as large as the number in high data rate mode. The reader/writer shall be ready to receive a frame from the transponder within 300 μs after having sent a frame to the transponder.

- Waveforms of SOF and EOF signals of a frame sent from a transponder (ISO commands)

- SOF



- EOF



- Waveforms of SOF and EOF signals of a frame sent from a transponder (fast commands)

- SOF

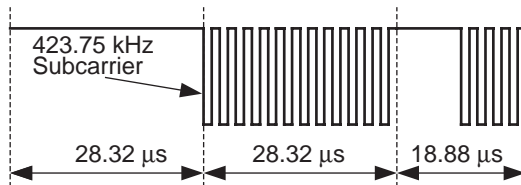

- EOF

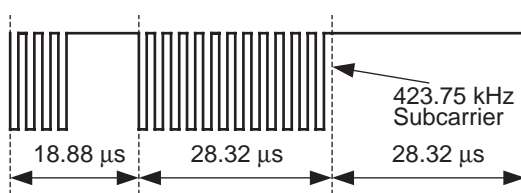

### 3. FRAM Data Protection if Power Lost During Data Writing

MB89R118 accesses to FRAM with the unit of 1 byte. When RF power is shut down during accessing FRAM, writing in FRAM is completed by the charges stored in a smoothing capacitor on the LSI and FRAM data writing error is prevented.

Therefore, the commands of 1 byte access such as Write AFI, Write DSFID, Write EAS, and Lock command can protect the data from the power down.

On the other hand, the commands of more than 2 bytes access such as Write Single Block command may not protect all the data from the power down during the access. In this case, it is recommended to confirm the data by read command if it's written correctly.

### 4. Requests/Responses

A request is sent from the reader/writer to the transponder. In reply to the request, the transponder sends a response to the reader/writer.

Each request, and response, is transmitted in each single frame.

- Structure of requests and responses

A request consists of the following 5 fields :

- Flag
- Command code
- Parameter (required or optional depending on the command)
- Application data
- CRC

A response consists of the following 4 fields :

- Flag
- Parameter (required or option depending on the command)
- Application data
- CRC

Each byte is transferred, beginning with the lowest bit. When two or more bytes are transferred, transfer begins with the lowest one.

## 5. Operating Modes

The MB89R118 has the following 3 operating modes :

Each mode specifies a different mechanism for how the transponder returns a response in reply to a request from the reader/writer :

- Addressed mode

The MB89R118 enters addressed mode when the Address\_flag is set to “1”.

In addressed mode, a request includes a UID (the Address\_flag is set to “1” simultaneously), and only the transponder that matches the UID in the request returns a response. If no transponder that matches the UID exists, a response is not returned.

- Non-Addressed mode

The MB89R118 enters non-addressed mode when the Address\_flag is set to “0”.

In non-addressed mode, a request does not include a UID. The transponders that receive the request execute processing and return response in accordance with the command in the request.

- Select mode

The MB89R118 enters select mode when the Select\_flag is set to “1”, and the address\_flag is set to “0”.

In select mode, do not include a UID as a request. Of the transponders that receive the command, only the transponder in the select state executes processing and returns a response in accordance with the command in the request.

## 6. Request Format

The following figure shows a typical example of the request data format, and the following table shows the definition of request flag bits.

- Structure of the request frame

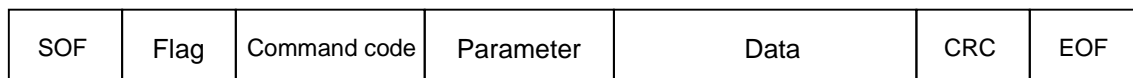

- Setting of Bit 1 to Bit 4

Bit	Flag name	1/0	State/Description
1	Sub-carrier_flag	0	1-subcarrier selected
		1	2-subcarrier selected (not supported)
2	Data_rate_flag	0	Low data rate (6.62 kbps) selected
		1	High data rate (26.48 kbps) selected
3	Inventory_flag	0	Command other than Inventory command selected
		1	Inventory command selected
4	Protocol_Extension_flag	0	Protocol not extended
		1	Protocol extended (RFU*)

\* : Reserved for future use

Note : “Inventory\_flag” of bit3 is determined whether “Inventory command” (select “1”) or other command (select “0”) is used.

# MB89R118

- Setting of Bit 5 to Bit 8 (When Inventory command is selected [Inventory\_flag = "1"])

Bit	Flag name	1/0	State/Description
5	AFI_flag	0	AFI not set
		1	AFI set (response when it is in accord with AFI of the transponder)
6	Nb_slots_flag	0	16-slots (for one or more transponders)
		1	1-slot (for one transponder)
7	Option_flag	0	Command option not supported
		1	Command option supported (not supported)
8	RFU*	0	Set to "0"
		1	—

\* : Reserved for future use

- Setting of Bit 5 to Bit 8 (When the command other than Inventory command is selected [Inventory\_flag = "0"])

Bit	Flag name	1/0	State/Description
5	Select_flag	0	Command flag decided by the setting of bit 6 and later bits.
		1	Select mode (the response is sent by only the transponder in select state)
6	Address_flag	0	Non-addressed mode (UID not included in the command)
		1	Addressed mode (UID included in the command)
7	Option_flag	0	Command option not supported (for the command not supporting the Option_flag)
		1	Command option supported
8	RFU*	0	Set to "0"
		1	—

\* : Reserved for future use

## 7. Response Format

The following figure shows a typical example of the response data format, and the following table shows the definition of the response flag bits.

If the error flag is set to "1", an error code field is generated in the response. If the error flag is set to "0", this means no error, and If the error flag is set to "1", this means any error generation.

- Structure of the response frame



• Response flag definitions

Bit	Flag name	1/0	Description
1	Error_flag	0	Error not found
		1	Error found
2	RFU*	0	Set to "0"
3	RFU*	0	Set to "0"
4	Extension_flag	0	Set to "0"
5	RFU*	0	Set to "0"
6	RFU*	0	Set to "0"
7	RFU*	0	Set to "0"
8	RFU*	0	Set to "0"

\* : Reserved for future use

• Error code definitions

Error code	Meaning
"01"	The specific command is not supported. Example: Command code error
"02"	Cannot recognize the command. The number of blocks is over the limit. Example: Format error
"03"	Specific options are not supported.
"0F"	Other errors
"10"	The specified block cannot be used (or was not found).
"11"	The specified block has already been locked and cannot be locked again.
"12"	The specified block has already been locked, and its contents cannot be updated.
"13"	The specified block could not be programmed normally (a write verify error occurred).
"14"	The specified block could not be locked normally (a lock verify error occurred) .
Others	Unused.

## 8. Anti-Collision Algorithm

The MB89R118 executes an anti-collision sequence loop based on an algorithm that complies with ISO/IEC 15693-3.

The anti-collision algorithm is designed to examine the transponders located within reader/writer communication areas on the basis of UID.

The reader/writer issues an Inventory command to transponders, and some transponders return responses while other transponders do not according to the algorithm explained in "10. Execution of Inventory Command by a Transponder".

## 9. REQUEST PARAMETER

### • Request Parameter Settings

Set the reader/writer as follows before issuing the Inventory command.

- The Nb\_slots\_flag (bit6), which is a request flag, is set to the desired value :  
 “0” : 16 slots (for plural transponders)  
 “1” : 1 slot (for single transponder)
- A mask length and a mask value are added after the command code.
- The mask length represents the data length of the mask value in bits.
- The mask value is integer bytes of data, transmitted beginning with the lowest bit. If the mask data is not a multiple of 8 (bits) in length, 0 is padded on the MSB side of the mask value so that the data is in units of bytes.

The following figure shows an example of the mask value with padding. Since the mask length is 12 bits, the mask value is padded with 4 bits on the MSB side so that the mask data is in units of bytes (2 bytes = 16 bits in this case).

If the AFI flag in the request flags is set in the format explained in “• Structure of the request frame of 6 Request Format”, an AFI field is added to the format. The command ends with transmission of an EOF signal as described in “1. Communication from Reader/Writer to Transponder”. Thereafter, processing in the first slot starts immediately. To proceed to the next slot, the reader/writer sends an EOF signal.

### • Format of the Command

SOF	Flag	Command code	Optional AFI	Mask length	Mask value	CRC	EOF
	8 bits	8 bits	8 bits	8 bits	0 to 64 bits	16 bits	

### • Example of the Mask Value with Padding

MSB	LSB
0000	0100 1100 1111
Pad	Mask value



## 10. Execution of Inventory Command by a Transponder

A transponder returns a response to the reader/writer when its UID is equal to the value that consists of the mask value and the number of slots. The mask value is sent in the Inventory command, and the number of slots is determined by the number of times the EOF signal is transmitted.

- Algorithm for execution of processing by a transponder

The following figure shows the algorithm for the execution of processing by a transponder when an Inventory command is received. The next figure shows the relationship between the UID and the mask value.

- Algorithm for Execution of Processing by a Transponder when Inventory Command

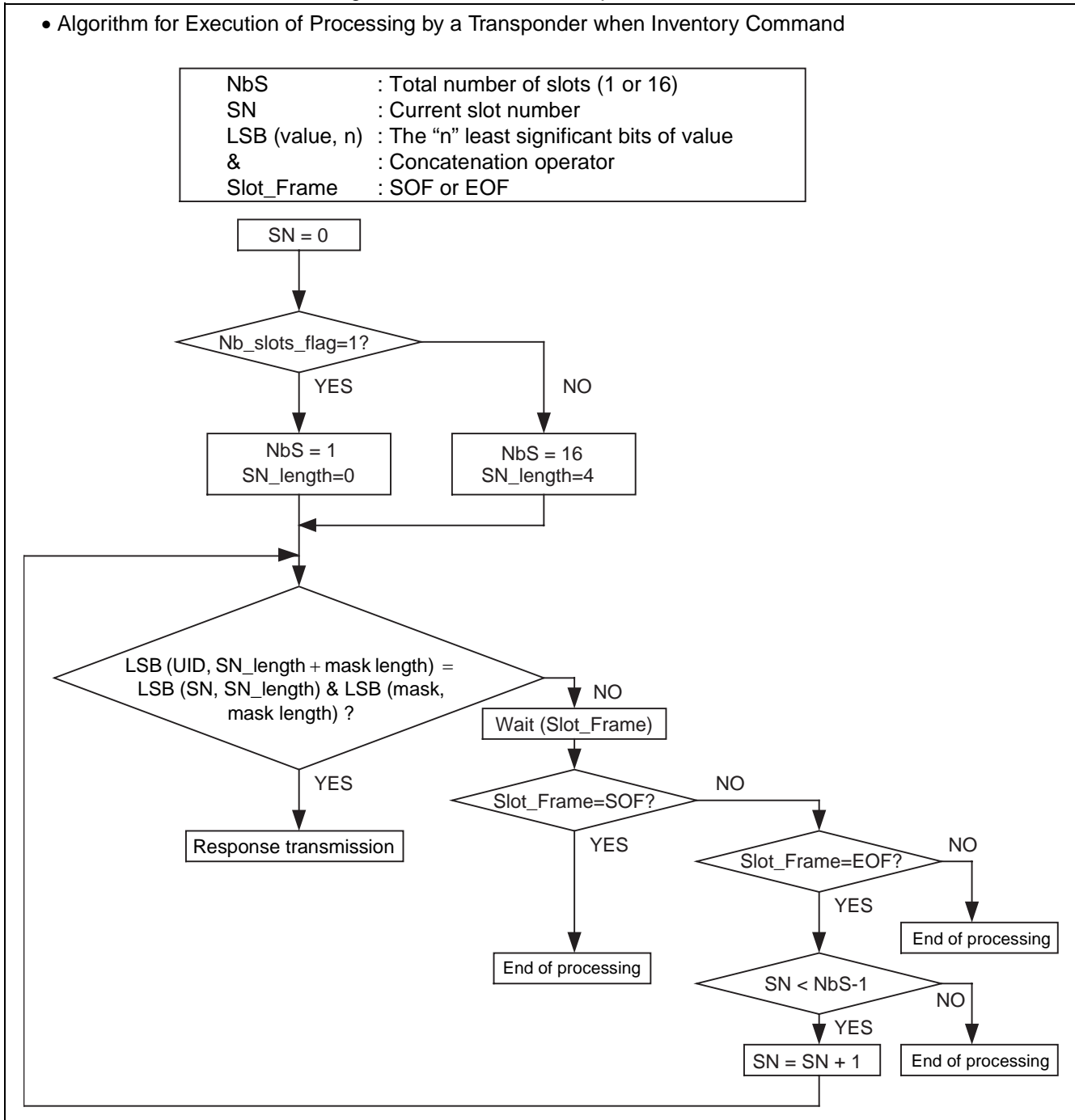

- Comparison of the mask value and the number of slots with the UID

Inventory command includes the mask value and mask length.  
The mask value is padded with "0" into the higher bit side so to make the byte-unit length (a multiple of 8 bits).

If Inventory command is received, the slot counter is reset to "0".

If EOF is received, the increment of the slot counter is started by the transponder.

The value is compared with the lowest bit in UID of the transponder.  
If the value is in accord with the mask value, the response is returned by the transponder.

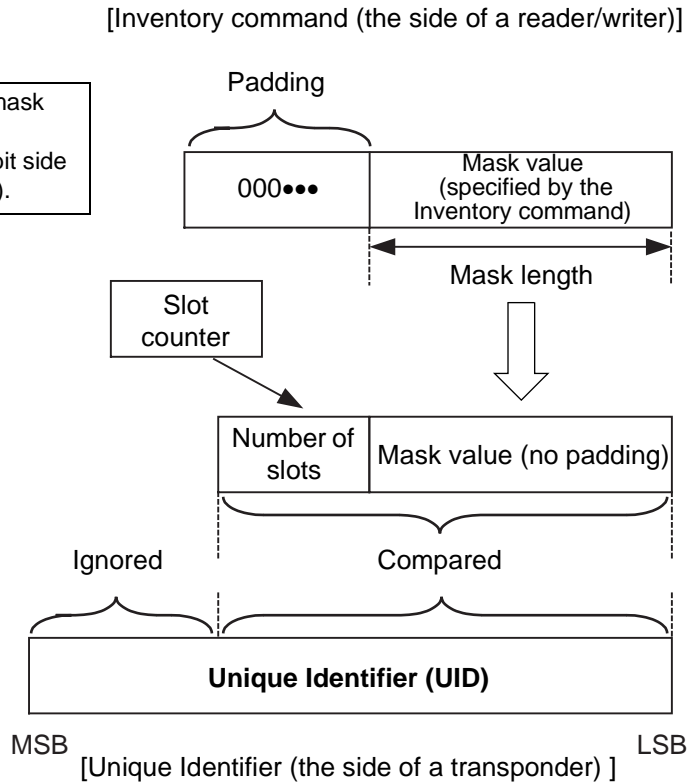

## 11. Anti-Collision Sequence

- Execution of anti-collision sequence

A typical anti-collision sequence that is applied when the number of slots is 16 is executed as follows :

- 1) The reader/writer sends an Inventory command.  
The Nb\_slots\_flag bit of the request flags is set to "0" to specify the number of slots.
- 2) In slot 0, transponder 1 transmits its response in the time t1\_a from the detection of the rising edge of the EOF. In this case no collision occurs and the UID of transponder is received and registered by the reader/writer.
- 3) The reader/writer sends an EOF signal to switch to the next slot in the time t2\_a after the response 1.
- 4) In slot 1, transponder 2 and transponder 3 transmit their response in the time t1\_a from the detection of the rising edge of the EOF. In this case, the reader/writer cannot recognize the UIDs of the two transponders because the collision occurs, and the reader/writer remembers that a collision was detected in slot 1.
- 5) The reader/writer sends an EOF signal to switch to the next slot in the time t2\_a after the responses.
- 6) In slot 2, no transponder transmits a response. The reader/writer does not detect any response, and sends an EOF signal to switch to the next slot in the time t3\_a from the detection of the rising edge of the EOF.
- 7) In slot 3, transponder 4 and transponder 5 transmit their response in the time t1\_a from the detection of the rising edge of the EOF, and another collision occurs.
- 8) The reader/writer sends a request (for example, a Read Single Block command, described later) to the transponder 1, which UID was already correctly received.
- 9) All transponders detect an SOF signal and exit the anti-collision sequence. In this case, since the request is addressed to transponder 1 (Addressed Mode), only transponder 1 transmits its response.
- 10) All transponders are ready to receive another request from the reader/writer. If the Inventory command is sent again, the anti-collision sequence starts from slot 0.

Note : t1\_a, t2\_a, t3\_a are specified in "12. Timing definitions".

# MB89R118

• Example of Anti-Collision Sequence

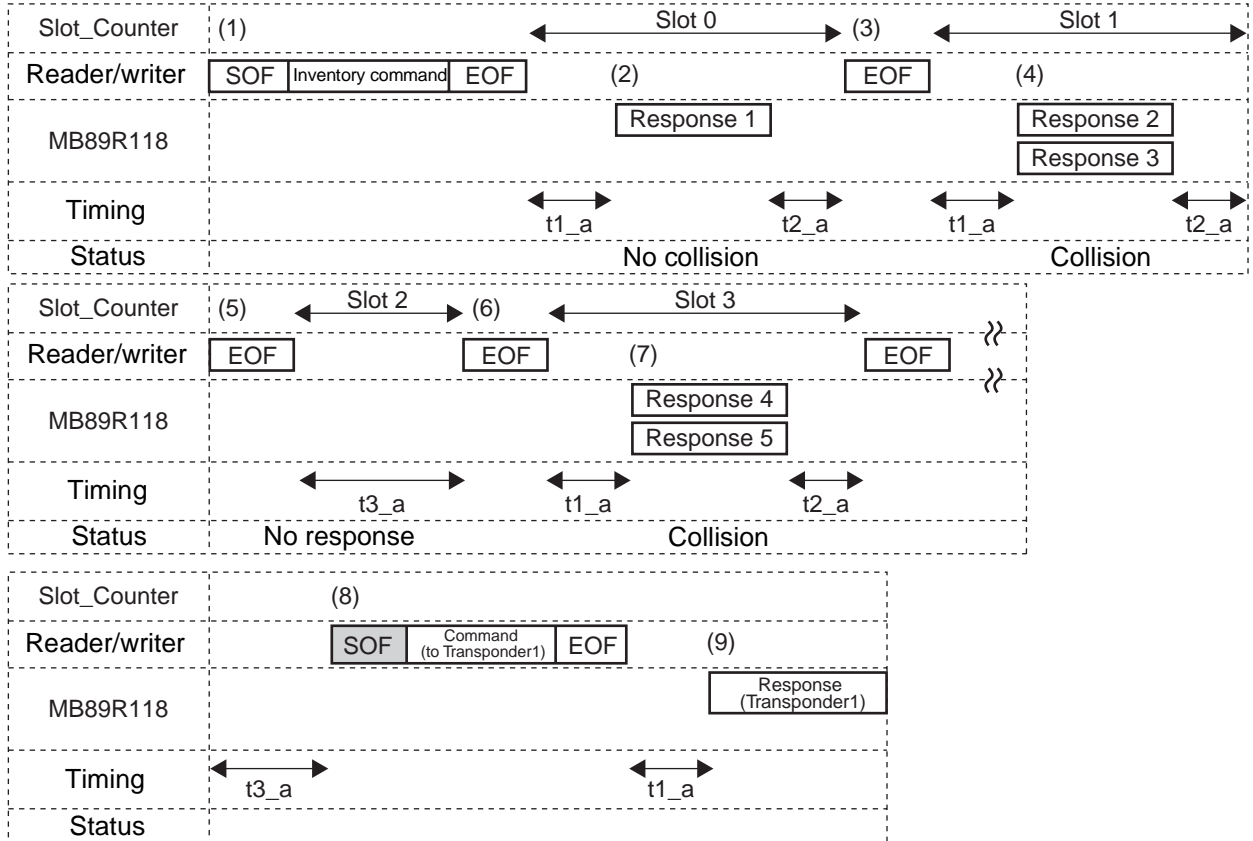

## 12. Timing definitions

### (1) Period during which the MB89R118 waits for the start of response transmission after an EOF signal transmitted from the reader/writer : t1\_a

After detection of an EOF signal sent from the reader/writer, MB89R118 must wait for a certain time (t1\_a) before sending a response to the reader/writer. t1\_a begins at the rising edge of the EOF pulse, and it is defined as following. The minimum value is  $4320/f_c$  ( $= 318.6 \mu\text{s}$ ), the nominal value is  $4352/f_c$  ( $= 320.9 \mu\text{s}$ ), and the maximum value is  $4384/f_c$  ( $= 323.3 \mu\text{s}$ ).

Even if the 10% ASK modulated signal from the reader/writer is detected within the time t1\_a, the transponder ignore the signal and wait for further time t1\_a before starting to transmit.

### (2) Period during which the MB89R118 ignores modulated signals after an EOF signal transmitted from the reader/writer : tmit

After detection of an EOF signal sent from the reader/writer, MB89R118 must ignore the 10% ASK modulated signals from the reader/writer for a time (tmit).

tmit begins at the rising edge of the EOF pulse. The minimum value of tmit is defined as  $4384/f_c$  ( $323.3 \mu\text{s}$ ) + tnrt. In the above expression, tnrt stands for the response time of MB89R118.

### (3) Period during which the reader/writer waits before sending a request : t2\_a

When the reader/writer has received a response from the transponder to a previous request other than Inventory and Stay Quiet command, it shall wait a time t2\_a before sending a subsequent request. The minimum value of t2\_a is  $309.2 \mu\text{s}$ . It is defined in ISO/IEC 15693-3. And ISO/IEC 18000-3 (Mode 1) .

### (4) Period during which the reader/writer waits before sending a request during execution of the Inventory command : t2inv

While an Inventory command is being executed, the reader/writer sends an EOF signal when it shifts to the next slot. In this case, the wait time is defined as follows depending on whether transponders return responses :

#### - Wait time applied when the reader/writer has received one or more responses : t2invwr

It is defined in ISO/IEC 15693-3. And ISO/IEC 18000-3 (Mode 1) that when the reader/writer has received one or more responses, the reader/writer must wait until responses from the transponders have been completed (that is, the reader/writer receives an EOF signal or tnrt passes). After that, the reader/writer must wait until t2\_a passes before sending an EOF signal to switch to the next slot.

#### - Wait time applied when the reader/writer has not received any responses : t3\_a

When the reader/writer has not received any responses from the MB89R118, the reader/writer must wait until t3\_a passes before sending an EOF signal. In this case, t3\_a begins at the rising edge of the EOF pulse that was sent previously. The minimum value of t3\_a is defined as  $4384/f_c$  ( $323.3 \mu\text{s}$ ) + tnrt.

#### • Timing Specifications

	Min	Typ	Max
t1_a	$4320/f_c = 318.6 \mu\text{s}$	$4352/f_c = 320.9 \mu\text{s}$	$4384/f_c = 323.3 \mu\text{s}$
tmit	$4384/f_c(323.3 \mu\text{s}) + \text{tnrt}$	—	—
t2_a	$4192/f_c = 309.2 \mu\text{s}$	—	—
t2invwr	t2_a + tnrt	—	—
t3_a	$4384/f_c(323.3 \mu\text{s}) + \text{tnrt}$	—	—

# MB89R118

## ■ COMMAND LIST

All Mandatory and Optional commands defined by ISO/IEC 15693-3 are supported.

The following Custom commands are supported :

- EAS command : Using for preventing the theft of goods and goods-monitoring
- Write EAS command : Writing data to the EAS bit
- Read Multiple Blocks Unlimited command : Enable to read FRAM area of up to 2048 bytes in a lump
- Fast command : Respond at double speed compared to ISO commands

### • Command list

Command code	Command name	Command Type	Details
"01 <sub>H</sub> "	Inventory	Mandatory	Execute the anti-collision sequence and get UID.
"02 <sub>H</sub> "	Stay Quiet	Mandatory	Enter the Quiet state
"20 <sub>H</sub> "	Read Single Block	Optional	Read the requested 1 block data in the user area/system area
"21 <sub>H</sub> "	Write Single Block	Optional	Write the requested 1 block data in the user area
"22 <sub>H</sub> "	Lock Block	Optional	Lock (disable to write) the requested 1 block in the user area
"23 <sub>H</sub> "	Read Multiple Blocks	Optional	Read the requested 1 or 2 blocks data in the user area/system area
"24 <sub>H</sub> "	Write Multiple Blocks	Optional	Write the requested 1 or 2 blocks data in the user area
"25 <sub>H</sub> "	Select	Optional	Enter the select (communication selected) state
"26 <sub>H</sub> "	Reset to Ready	Optional	Enter the ready (communication enabled) state
"27 <sub>H</sub> "	Write AFI	Optional	Write AFI (Application Family Identifier) data into FRAM.
"28 <sub>H</sub> "	Lock AFI	Optional	Lock AFI data (disable to write)
"29 <sub>H</sub> "	Write DSFID	Optional	Write DSFID (Data Storage Format Identifier) data into FRAM
"2A <sub>H</sub> "	Lock DSFID	Optional	Lock DSFID (Data Storage Format Identifier) data (disable to write)
"2B <sub>H</sub> "	Get System Information	Optional	Read the system information value (UID, DSFID, AFI, number of bytes per block, number of blocks in user area, and IC information)
"2C <sub>H</sub> "	Get Multiple Block Security Status	Optional	Read the block security status stored in system area.
"A0 <sub>H</sub> "	EAS	Custom	When EAS bit is "1", reply response code 6 times.
"A1 <sub>H</sub> "	Write EAS	Custom	Write EAS data (1 bit). Data "1" validates anti-theft/goods-monitoring, and data "0" invalidates them.
"A5 <sub>H</sub> "	Read Multiple Blocks Unlimited	Custom	Read the specified data of up to 256 blocks in the user area/system area.
"B1 <sub>H</sub> "	Fast Inventory	Custom	Fast response Inventory command
"C0 <sub>H</sub> "	Fast Read Single Block	Custom	Fast response Read Single Block command
"C1 <sub>H</sub> "	Fast Write Single Block	Custom	Fast response Write Single Block command
"C3 <sub>H</sub> "	Fast Read Multiple Blocks	Custom	Fast response Read Multiple Blocks command
"C4 <sub>H</sub> "	Fast Write Multiple Blocks	Custom	Fast response Write Multiple Blocks command
"D1 <sub>H</sub> "	Fast Write EAS	Custom	Fast response Write EAS command
"D5 <sub>H</sub> "	Fast Read Multiple Blocks Unlimited	Custom	Fast response Read Multiple Blocks Unlimited command

## ■ COMMAND DESCRIPTION

### 1. Description of Mandatory Command

#### 1-1. Inventory command

The Inventory command executes the anti-collision sequence.

Even though an error is detected during execution of this command, a response indicating the error is not returned.

The Inventory\_flag (bit 3) must be set to "1".

When the AFI\_flag (bit 5) in the Inventory command frame is set as "1", the response is returned in the following cases.

- The AFI value of the transponder is in accord with the optional AFI value.
- The optional AFI value is "00H".

- Request

[Request from the reader/writer to the transponder]

SOF	Flag	Command (Inventory)	Optional AFI	Mask length	Mask value	CRC	EOF
	8 bits	8 bits ("01H")	8 bits	8 bits	0 to 64 bits	16 bits	

- Response

[Response from the transponder to the reader/writer]

SOF	Flag	DSFID	UID	CRC	EOF
	8 bits ("00H")	8 bits	64 bits	16 bits	

#### 1-2. Stay Quiet command

On receiving the Stay Quiet command, the transponder enters the quiet state. The transponder does not return any responses, including an error indication.

In the quiet state, the transponder does not execute any request for which the Inventory\_flag (bit 3) is set to "1" and executes only a command for which the Address\_flag (bit 6) is set to "1".

The transponder exits the quiet state only in the following cases:

- The transponder enters the power-off state.
- The transponder receives the Select command and enters the select state.
- The transponder receives the Reset to Ready command and enters the ready state.

- Request

[Request from the reader/writer to the transponder]

SOF	Flag	Command (Stay Quiet)	UID (necessary)	CRC	EOF
	8 bits	8 bits ("02H")	64 bits	16 bits	

- Response

[Response from the transponder to the reader/writer]

No response

## 2. Description of Optional Command

### 2-1. Read Single Block command

On receiving the Read Single Block command, the transponder reads the data stored in the specified single-block to the reader/writer.

If the Option\_flag (bit 7) is "1", the transponder adds block security status information in the response. If the Option\_flag (bit 7) is "0", the transponder returns only the data in the specified block to the reader/writer.

- Request

[Request from the reader/writer to the transponder]

SOF	Flag	Command (Read Single Block)	UID (Addressed mode)	Number of blocks	CRC	EOF
	8 bits	8 bits ("20H")	64 bits	8 bits	16 bits	

- Response

[Response from the transponder to the reader/writer]

(1) When Error\_flag set

SOF	Flag	Error code	CRC	EOF
	8 bits ("01H")	8 bits	16 bits	

(2) When Error\_flag not set

SOF	Flag	Block security status (option)	Data	CRC	EOF
	8 bits ("00H")	8 bits	64 bits	16 bits	

### 2-2. Write Single Block command

On receiving the Write Single Block command, the transponder writes the single-block data included in the request to the specified block.

The transponder performs verification after writing and returns an error code if the writing has failed.

If the Option\_flag (bit 7) is "0", the transponder shall return its response when it has completed the write operation starting after  $\langle t_{1nom} + \text{a multiple of } 4096/f_c (302.1 \mu\text{s}) \rangle$  with total tolerance of  $\pm 32/f_c (2.4 \mu\text{s})$  and latest within 20 ms. If it is "1", transponder shall wait for the reception of an EOF from the reader/writer and upon such reception still return its response  $\langle t_{1nom} : \text{typical } 320.9 \mu\text{s} \rangle$  (However, if an EOF is not sent within 38 ms, the time-out occurs and the transponder can receive another command).

- Request

[Request from the reader/writer to the transponder]

SOF	Flag	Command (Write Single Block)	UID (Addressed mode)	Number of blocks	Data	CRC	EOF
	8 bits	8 bits ("21H")	64 bits	8 bits	64 bits	16 bits	



- Response

[Response from the transponder to the reader/writer]

(1) When Error\_flag set

SOF	Flag	Error code	CRC	EOF
	8 bits ("01 <sub>H</sub> ")	8 bits	16 bits	

(2) When Error\_flag not set

SOF	Flag	CRC	EOF
	8 bits ("00 <sub>H</sub> ")	16 bits	

## 2-3. Lock Block command

On receiving the Lock Block command, the transponder locks (write disable) permanently the data stored in one specified single-block.

The transponder performs verification after writing and returns an error code if the writing has failed.

If the Option\_flag (bit 7) is "0", the transponder shall return its response when it has completed the lock operation starting after  $\langle t_{1nom} + \text{a multiple of } 4096/f_c (302.1 \mu\text{s}) \rangle$  with total tolerance of  $\pm 32/f_c (2.4 \mu\text{s})$  and latest within 20 ms. If it is "1", transponder shall wait for the reception of an EOF from the reader/writer and upon such reception still return its response. (However, if an EOF is not sent within 38 ms, the time-out occurs and the transponder can receive another command.)

Once the Lock Block command has been received, data in the locked block cannot be changed by the Write Single (Multiple) Block (s) command.

- Request

[Request from the reader/writer to the transponder]

SOF	Flag	Command (Lock Block)	UID (Addressed mode)	Number of blocks	CRC	EOF
	8 bits	8 bits ("22 <sub>H</sub> ")	64 bits	8 bits	16 bits	

- Response

[Response from the transponder to the reader/writer]

(1) When Error\_flag set

SOF	Flag	Error code	CRC	EOF
	8 bits ("01 <sub>H</sub> ")	8 bits	16 bits	

(2) When Error\_flag not set

SOF	Flag	CRC	EOF
	8 bits ("00 <sub>H</sub> ")	16 bits	

# MB89R118

## 2-4. Read Multiple Blocks Command

On receiving the Read Multiple Blocks command, the transponder reads the data stored in the specified successive blocks to the reader/writer.

Up to 2 blocks of data can be read for one request.

If the Option\_flag (bit 7) is “1”, the transponder adds block security status information in the response. If the Option\_flag (bit 7) is “0”, the transponder returns only the data in the specified blocks to the reader/writer.

The value of the “number of blocks” field specified in the request is the expected number of blocks minus 1.

Setting the number of blocks to “01<sub>H</sub>” makes a request to read 2 blocks. Setting the number of blocks to “00<sub>H</sub>” makes a request to read 1 block (the request having the same effect as the Read Single Block command).

Note : For execution in the addressed mode, the Read Multiple Blocks command must be run without shutting off the RF power supply after obtaining the UID, for example, using the Inventory command. No response may be expected when RF power supply is not stable.

- Request

[Request from the reader/writer to the transponder]

SOF	Flag	Command (Read Multiple Blocks)	UID (Addressed mode)	First block number	Number of blocks	CRC	EOF
	8 bits	8 bits (“23 <sub>H</sub> ”)	64 bits	8 bits	8 bits	16 bits	

- Response

[Response from the transponder to the reader/writer]

(1) When Error\_flag set

SOF	Flag	Error code	CRC	EOF
	8 bits (“01 <sub>H</sub> ”)	8 bits	16 bits	

(2) When Error\_flag not set

SOF	Flag	Block security status (option)	Data	CRC	EOF
	8 bits (“00 <sub>H</sub> ”)	8 bits	64 bits	16 bits	
Repeated as required					

## 2-5. Write Multiple Blocks Command

On receiving the Write Multiple Blocks command, the transponder writes the successive multiple-block data included in the request to the specified blocks.

Up to 2 blocks of data can be written for one request.

The transponder performs verification after writing and returns an error code if the writing has failed. The number of blocks specified in the Write Multiple Blocks command is similar to the number of blocks specified in the Read Multiple Blocks command. The value of the number of blocks field specified in the Write Multiple Blocks command is obtained by subtracting 1 from the number of the expected blocks to be written.

Setting the number of blocks to “01<sub>H</sub>” makes a request to write 2 blocks. Setting the number of blocks to “00<sub>H</sub>” makes a request to write 1 block (the request having the same effect as the Write Single Block command).

If at least one of the blocks specified by the request is locked, the transponder does not write any data and, instead, returns an error code.

If the Option\_flag (bit 7) is “0”, the transponder shall return its response when it has completed the write operation starting after  $\langle t_{1nom} + a \text{ multiple of } 4096/f_c (302.1 \mu s) \rangle$  with total tolerance of  $\pm 32/f_c (2.4 \mu s)$  and latest within

20 ms. If it is “1”, transponder shall wait for the reception of an EOF from the reader/writer and upon such reception still return its response (However, if an EOF is not sent within 38 ms, the time-out occurs and the transponder can receive another command) .

- Request

[Request from the reader/writer to the transponder]

SOF	Flag	Command (Write Multiple Blocks)	UID (Addressed mode)	First block number	Number of blocks	Data	CRC	EOF
	8 bits	8 bits (“24 <sub>H</sub> ”)	64 bits	8 bits	8 bits	64 bits or 128 bits	16 bits	

- Response

[Response from the transponder to the reader/writer]

(1) When Error\_flag set

SOF	Flag	Error code	CRC	EOF
	8 bits (“01 <sub>H</sub> ”)	8 bits	16 bits	

(2) When Error\_flag not set

SOF	Flag	CRC	EOF
	8 bits (“00 <sub>H</sub> ”)	16 bits	

## 2-6. Select command

Of the transponders that received the Select command, only the transponder whose UID matches the UID included in the request enters the select state and returns a response.

The other transponders, whose UIDs do not match the UID in the request, enter the ready states without returning any response. The Select command is used only in addressed mode.

- Request

[Request from the reader/writer to the transponder]

SOF	Flag	Command (Select)	UID (necessary)	CRC	EOF
	8 bits	8 bits (“25 <sub>H</sub> ”)	64 bits	16 bits	

- Response

[Response from the transponder to the reader/writer]

(1) When Error\_flag set

SOF	Flag	Error code	CRC	EOF
	8 bits (“01 <sub>H</sub> ”)	8 bits	16 bits	

(2) When Error\_flag not set

SOF	Flag	CRC	EOF
	8 bits (“00 <sub>H</sub> ”)	16 bits	

# MB89R118

## 2-7. Reset to Ready command

On receiving the Reset to Ready command, the transponder enters the ready state.

- Request

[Request from the reader/writer to the transponder]

SOF	Flag	Command (Reset to Ready)	UID (Addressed mode)	CRC	EOF
	8 bits	8 bits ("26H")	64 bits	16 bits	

- Response

[Response from the transponder to the reader/writer]

(1) When Error\_flag set

SOF	Flag	Error code	CRC	EOF
	8 bits ("01H")	8 bits	16 bits	

(2) When Error\_flag not set

SOF	Flag	CRC	EOF
	8 bits ("00H")	16 bits	

## 2-8. Write AFI command

On receiving the Write AFI command, the transponder writes the data of AFI to FRAM.

The transponder performs verification after writing and returns an error code if the writing has failed.

If the Option\_flag (bit 7) is "0", the transponder shall return its response when it has completed the write operation starting after  $\langle t_{1nom} + \text{a multiple of } 4096/f_c (302.1 \mu\text{s}) \rangle$  with total tolerance of  $\pm 32/f_c (2.4 \mu\text{s})$  and latest within 20 ms. If it is "1", transponder shall wait for the reception of an EOF from the reader/writer and upon such reception still return its response (However, if an EOF is not sent within 38 ms, the time-out occurs and the transponder can receive another command) .

- Request

[Request from the reader/writer to the transponder]

SOF	Flag	Command (Write AFI)	UID (Addressed mode)	AFI	CRC	EOF
	8 bits	8 bits ("27H")	64 bits	8 bits	16 bits	

- Response

[Response from the transponder to the reader/writer]

(1) When Error\_flag set

SOF	Flag	Error code	CRC	EOF
	8 bits ("01H")	8 bits	16 bits	

(2) When Error\_flag not set

SOF	Flag	CRC	EOF
	8 bits ("00H")	16 bits	

## 2-9. Lock AFI command

On receiving the Lock AFI command, the transponder locks (write disable) permanently the data of AFI.

The transponder performs verification after writing and returns an error code if the writing has failed.

If the Option\_flag (bit 7) is "0", the transponder shall return its response when it has completed the lock operation starting after  $\langle t_{1nom} + \text{a multiple of } 4096/f_c (302.1 \mu\text{s}) \rangle$  with total tolerance of  $\pm 32/f_c (2.4 \mu\text{s})$  and latest within 20 ms. If it is "1", transponder shall wait for the reception of an EOF from the reader/writer and upon such reception still return its response (However, if an EOF is not sent within 38 ms, the time-out occurs and the transponder can receive another command) .

Once the Lock AFI command has been received, the data of AFI cannot be changed by the Write AFI command.

- Request

[Request from the reader/writer to the transponder]

SOF	Flag	Command (Lock AFI)	UID (Addressed mode)	CRC	EOF
	8 bits	8 bits ("28H")	64 bits	16 bits	

- Response

[Response from the transponder to the reader/writer]

(1) When Error\_flag set

SOF	Flag	Error code	CRC	EOF
	8 bits ("01H")	8 bits	16 bits	

(2) When Error\_flag not set

SOF	Flag	CRC	EOF
	8 bits ("00H")	16 bits	

## 2-10. Write DSFID command

On receiving the Write DSFID command, the transponder writes the data of DSFID to FRAM.

The transponder performs verification after writing and returns an error code if the writing has failed.

If the Option\_flag (bit 7) is "0", the transponder shall return its response when it has completed the write operation starting after  $\langle t_{1nom} + \text{a multiple of } 4096/f_c (302.1 \mu\text{s}) \rangle$  with total tolerance of  $\pm 32/f_c (2.4 \mu\text{s})$  and latest within 20 ms. If it is "1", transponder shall wait for the reception of an EOF from the reader/writer and upon such reception still return its response (However, if an EOF is not sent within 38 ms, the time-out occurs and the transponder can receive another command) .

- Request

[Request from the reader/writer to the transponder]

SOF	Flag	Command (Write DSFID)	UID (Addressed mode)	DSFID	CRC	EOF
	8 bits	8 bits ("29H")	64 bits	8 bits	16 bits	

- Response

[Response from the transponder to the reader/writer]

(1) When Error\_flag set

SOF	Flag	Error code	CRC	EOF
	8 bits ("01H")	8 bits	16 bits	

(2) When Error\_flag not set

SOF	Flag	CRC	EOF
	8 bits ("00H")	16 bits	

## 2-11. Lock DSFID command

On receiving the Lock DSFID command, the transponder locks (write disable) permanently the data of DSFID.

The transponder performs verification after writing and returns an error code if the writing has failed.

If the Option\_flag (bit 7) is "0", the transponder shall return its response when it has completed the lock operation starting after  $\langle t_{1nom} + \text{a multiple of } 4096/f_c (302.1 \mu\text{s}) \rangle$  with total tolerance of  $\pm 32/f_c (2.4 \mu\text{s})$  and latest within 20 ms. If it is "1", transponder shall wait for the reception of an EOF from the reader/writer and upon such reception still return its response (However, if an EOF is not sent within 38 ms, the time-out occurs and the transponder can receive another command) .

Once the Lock DSFID command has been received, the data of DSFID cannot be changed by the Write DSFID command.

- Request

[Request from the reader/writer to the transponder]

SOF	Flag	Command (Lock DSFID)	UID (Addressed mode)	CRC	EOF
	8 bits	8 bits ("2AH")	64 bits	16 bits	

- Response

[Response from the transponder to the reader/writer]

(1) When Error\_flag set

SOF	Flag	Error code	CRC	EOF
	8 bits ("01H")	8 bits	16 bits	

(2) When Error\_flag not set

SOF	Flag	CRC	EOF
	8 bits ("00H")	16 bits	

## 2-12. Get System Information command

On receiving the Get System Information command, the transponder reads the chip information of UID, AFI, DSFID, and so on to the reader/writer as a response.

- Request

[Request from the reader/writer to the transponder]

SOF	Flag	Command (Get System Information)	UID (Addressed mode)	CRC	EOF
	8 bits	8 bits ("2BH")	64 bits	16 bits	

- Response

[Response from the transponder to the reader/writer]

(1) When Error\_flag set

SOF	Flag	Error code	CRC	EOF
	8 bits ("01H")	8 bits	16 bits	

(2) When Error\_flag not set

SOF	Flag	Information flag	UID	DSFID	AFI	Memory size	IC reference	CRC	EOF
	8 bits ("00H")	8 bits	64 bits	8 bits	8 bits	16 bits	8 bits	16 bits	

The followings show the definitions of the Information flag and the memory size information (transponder memory size information) included in the response of the Get System Information command. However, the size of blocks and number of blocks in the user area shown in the memory size information about a transponder indicate one less than the actual value.

- Definition of information flag

Bit	Flag name	State	Description
1	DSFID	0	DSFID is not supported or does not exist.
		1	DSFID is supported or exists.
2	AFI	0	AFI is not supported or does not exist.
		1	AFI is supported or exists.
3	Memory size	0	Memory size information is not supported or does not exist.
		1	Memory size information is supported or exists.
4	IC reference	0	IC reference information is not supported or does not exist.
		1	IC reference information is supported or exists.
5	RFU*	—	Set to "0"
6	RFU*	—	
7	RFU*	—	
8	RFU*	—	

\* : Reserved for future use

Note : For MB89R118, set "0FH" (set "1" for bit 1 to bit 4 and set "0" for bit 5 to bit 8) .

# MB89R118

- Memory size information about a transponder

MSB				LSB			
16	14	13	9	8			1
RFU*		Size of blocks (Number of bytes in 1 block)			Number of blocks in the user area		

\* : Reserved for future use

Note : The memory size of the MB89R118 which is consisted of 250 blocks (8 bytes per block) in the user area, the memory size information is hexadecimal "07F9H".

## 2-13. Get Multiple Block Security Status Command

On receiving the Get Multiple Block Security Status command, the transponder reads the block security status stored in a system area to the reader/writer as a response.

Up to 64 blocks of data can be read for one request. The number of blocks specified in this request must be the value that is 1 block less than the actual number of the blocks whose security status is to be obtained.

The first block number specified in this request must be a multiple of 8.

- Request

[Request from the reader/writer to the transponder]

SOF	Flag	Command (Get Multiple Block Security Status)	UID (Addressed mode)	First block number	Number of blocks	CRC	EOF
	8 bits	8 bits ("2CH")	64 bits	8 bits	8 bits	16 bits	

- Response

[Response from the transponder to the reader/writer]

(1) When Error\_flag set

SOF	Flag	Error code	CRC	EOF
	8 bits ("01H")	8 bits	16 bits	

(2) When Error\_flag not set

SOF	Flag	Block security status	CRC	EOF
	8 bits ("00H")	8 bits (repeated as required)	16 bits	



## 3. Custom Command

The IC manufacturing code is required to use a Custom command. The IC manufacturing code for the MB89R118 is "08H".

### 3-1. EAS command

On EAS command reception, the transponder returns the response code "5AH" repeated 6 times after the specified flag ("00H") if the EAS bit is "1" or returns no response if the EAS bit is "0". The EAS command can be executed only when the transponder is in the ready or select state.

- Request

[Request from the reader/writer to the transponder]

SOF	Flag	Command (EAS)	IC manufacturer code (necessary)	CRC	EOF
	8 bits	8 bits ("A0H")	8 bits ("08H")	16 bits	

- Response

[Response from the transponder to the reader/writer]

SOF	Flag	Response code	CRC	EOF
	8 bits ("00H")	48 bits (6 times repeat of "5AH")	16 bits	

### 3-2. Write EAS command

On write EAS command reception, the transponder writes the EAS bit to FRAM.

The transponder performs verification after writing and returns an error code if the writing has failed.

The EAS bit must be set to "00H" to cancel anti-theft or goods-monitoring mode. The bit must be set to "01H" to set up the goods-monitoring mode as the EAS data.

If the Option\_flag (bit 7) is "0", the transponder shall return its response when it has completed the write operation starting after  $<t_{1nom} + \text{a multiple of } 4096/f_c (302.1 \mu\text{s})>$  with total tolerance of  $\pm 32/f_c (2.4 \mu\text{s})$  and latest within 20 ms. If it is "1", transponder shall wait for the reception of an EOF from the reader/writer and upon such reception still return its response (However, if an EOF is not sent within 38 ms, the time-out error occurs and the transponder can receive another command) .

- Request

[Request from the reader/writer to the transponder]

SOF	Flag	Command (Write EAS)	IC manufacturer code (necessary)	UID (Addressed mode)	Data	CRC	EOF
	8 bits	8 bits ("A1H")	8 bits ("08H")	64 bits	8 bits ("00H" or "01H")	16 bits	

- Response

[Response from the transponder to the reader/writer]

(1) When Error\_flag set

SOF	Flag	Error code	CRC	EOF
	8 bits ("01H")	8 bits	16 bits	

# MB89R118

(2) When Error\_flag not set

SOF	Flag	CRC	EOF
	8 bits ("00H")	16 bits	

### 3-3. Read Multiple Blocks Unlimited Command

On receiving the Read Multiple Blocks Unlimited command, the transponder reads the data stored in the specified successive blocks to the reader/writer as a response.

Up to 256 blocks of data can be read for one request.

If the Option\_flag (bit 7) is "1", the transponder adds block security status information in the response. If the Option\_flag (bit 7) is "0", the transponder returns only the data in the specified blocks to the reader/writer.

The value of the "number of blocks" field specified in the request is the expected number of blocks minus 1.

Setting the number of blocks to "06H" makes a request to read 7 blocks. Up to "FFH" blocks can be set. (Note that the maximum number of blocks is changed by setting the leading block number.)

- Request

[Request from the reader/writer to the transponder]

SOF	Flag	Command (Read Multiple Blocks Unlimited)	IC manufacturer code (necessary)	UID (Addressed mode)	First block number	Number of blocks	CRC	EOF
	8 bits	8 bits ("A5H")	8 bits ("08H")	64 bits	8 bits	8 bits	16 bits	

- Response

[Response from the transponder to the reader/writer]

(1) When Error\_flag set

SOF	Flag	Error code	CRC	EOF
	8 bits ("01H")	8 bits	16 bits	

(2) When Error\_flag not set

SOF	Flag	Block security status(option)	Data	CRC	EOF
	8 bits ("00H")	8 bits	64 bits	16 bits	
Repeated as required					

### 3-4. Fast Inventory Command

The Fast Inventory command is the same as the Inventory Command that executes the anti-collision sequence.

The data rate in the response is twice as defined in ISO/IEC 15693.

Even though an error is detected during execution of this command, a response indicating the error is not returned.

The Inventory\_flag (bit 3) must be set to "1".

When the AFI\_flag (bit 5) in the Inventory command frame is set as "1", the response is returned in the following cases.

- The AFI value of the transponder is in accord with the optional AFI value.
- The optional AFI value is "00H".

- Request

[Request from the reader/writer to the transponder]

SOF	Flag	Command (Fast Inventory)	IC manufacturer code (necessary)	Optional AFI	Mask length	Mask value	CRC	EOF
	8 bits	8 bits ("B1H")	8 bits ("08H")	8 bits	8 bits	0 to 64 bits	16 bits	

- Response

[Response from the transponder to the reader/writer]

SOF	Flag	DSFID	UID	CRC	EOF
	8 bits ("00H")	8 bits	64 bits	16 bits	

### 3-5. Fast Read Single Block Command

The Fast Read Single Block command is the same as the Read Single Block command that reads the data stored in the specific single-block. The data rate in the response is twice as defined in ISO/IEC 15693.

If the Option\_flag (bit 7) is "1", the transponder adds block security status information in the response. If the Option\_flag (bit 7) is "0", the transponder returns only the data in the specified block to the reader/writer.

- Request

[Request from the reader/writer to the transponder]

SOF	Flag	Command (Fast Read Single Block)	IC manufacturer code (necessary)	UID (Addressed mode)	Number of blocks	CRC	EOF
	8 bits	8 bits ("C0H")	8 bits ("08H")	64 bits	8 bits	16 bits	

- Response

[Response from the transponder to the reader/writer]

(1) When Error\_flag set

SOF	Flag	Error code	CRC	EOF
	8 bits ("01H")	8 bits	16 bits	

(2) When Error\_flag not set

SOF	Flag	Block security status(option)	Data	CRC	EOF
	8 bits ("00H")	8 bits	64 bits	16 bits	

### 3-6. Fast Write Single Block Command

The Fast Write Single Block command is the same as the Write Single Block command that writes the single-block data included in the request. The data rate in the response is twice as defined in ISO/IEC 15693.

The transponder performs verification after writing and returns an error code if the writing has failed.

If the Option\_flag (bit 7) is "0", the transponder shall return its response when it has completed the write operation starting after  $\langle t_{1nom} + \text{a multiple of } 4096/f_c \text{ (302.1 } \mu\text{s)} \rangle$  with total tolerance of  $\pm 32/f_c \text{ (2.4 } \mu\text{s)}$  and latest within 20 ms. If it is "1", transponder shall wait for the reception of an EOF from the reader/writer and upon such reception still return its response  $\langle t_{1nom} : \text{typical } 320.9 \mu\text{s} \rangle$  (However, if an EOF is not sent within 38 ms, the time-out occurs and the transponder can receive another command) .

# MB89R118

- Request

[Request from the reader/writer to the transponder]

SOF	Flag	Command (Fast Write Single Block)	IC manufacturer code (necessary)	UID (Addressed mode)	Number of blocks	Data	CRC	EOF
	8 bits	8 bits ("C1H")	8 bits ("08H")	64 bits	8 bits	64 bits	16 bits	

- Response

[Response from the transponder to the reader/writer]

(1) When Error\_flag set

SOF	Flag	Error code	CRC	EOF
	8 bits ("01H")	8 bits	16 bits	

(2) When Error\_flag not set

SOF	Flag	CRC	EOF
	8 bits ("00H")	16 bits	

### 3-7. Fast Read Multiple Blocks Command

The Fast Read Multiple Blocks command is the same as the Read Multiple Blocks command that reads the data of the specified successive blocks.

Up to 2 blocks of data can be read for one request. The data rate in the response is twice as defined in ISO/IEC 15693.

If the Option\_flag (bit 7) is "1", the transponder adds block security status information in the response. If the Option\_flag (bit 7) is "0", the transponder returns only the data in the specified blocks to the reader/writer.

The value of the "number of blocks" field specified in the request is the expected number of blocks minus 1.

Setting the number of blocks to "01H" makes a request to read 2 blocks. Setting the number of blocks to "00H" makes a request to read 1 block (the request having the same effect as the Fast Read Single Block command).

Note : For execution in the addressed mode, the Fast Read Multiple Blocks command must be run without shutting off the RF power supply after obtaining the UID, for example, using the Inventory command. No response may be expected when RF power supply is not stable.

- Request

[Request from the reader/writer to the transponder]

SOF	Flag	Command (Fast Read Multiple Blocks)	IC manufacturer code (necessary)	UID (Addressed mode)	First block number	Number of blocks	CRC	EOF
	8 bits	8 bits ("C3H")	8 bits ("08H")	64 bits	8 bits	8 bits	16 bits	

- Response

[Response from the transponder to the reader/writer]

(1) When Error\_flag set

SOF	Flag	Error code	CRC	EOF
	8 bits ("01H")	8 bits	16 bits	

(2) When Error\_flag not set

SOF	Flag	Block security status(option)	Data	CRC	EOF
	8 bits ("00H")	8 bits	64 bits	16 bits	
Repeated as required					

### 3-8. Fast Write Multiple Blocks Command

The Fast Write Multiple Blocks command is the same as the Write Multiple Blocks command that writes the successive multiple-block data included in the request.

Up to 2 blocks of data can be written for one request. The data rate in the response is twice as defined in ISO/IEC 15693.

The transponder performs verification after writing and returns an error code if the writing has failed. The number of blocks specified in the Fast Write Multiple Blocks command is similar to the number of blocks specified in the Read Multiple Blocks command. The value of the number of blocks field specified in the Fast Write Multiple Blocks command is obtained by subtracting 1 from the number of the expected blocks to be written.

Setting the number of blocks to "01H" makes a request to write 2 blocks. Setting the number of blocks to "00H" makes a request to write 1 block (the request having the same effect as the Fast Write Single Block command). If at least one of the blocks specified by the request is locked, the transponder does not write any data and, instead, returns an error code.

If the Option\_flag (bit 7) is "0", the transponder shall return its response when it has completed the write operation starting after  $\langle t_{1nom} + \text{a multiple of } 4096/f_c (302.1 \mu\text{s}) \rangle$  with total tolerance of  $\pm 32/f_c (2.4 \mu\text{s})$  and latest within 20 ms. If it is "1", transponder shall wait for the reception of an EOF from the reader/writer and upon such reception still returns its response (However, if an EOF is not sent within 38 ms, the time-out occurs and the transponder can receive another command) .

- Request

[Request from the reader/writer to the transponder]

SOF	Flag	Command (Fast Write Multiple Blocks)	IC manufacturer code	UID (Addressed mode)	First block number	Number of blocks	Data	CRC	EOF
	8 bits	8 bits ("C4H")	8 bits ("08H")	64 bits	8 bits	8 bits	64 bits or 128 bits	16 bits	

- Response

[Response from the transponder to the reader/writer]

(1) When Error\_flag set

SOF	Flag	Error code	CRC	EOF
	8 bits ("01H")	8 bits	16 bits	

(2) When Error\_flag not set

SOF	Flag	CRC	EOF
	8 bits ("00H")	16 bits	

# MB89R118

## 3-9. Fast Write EAS Command

The Fast Write EAS command is the same as Write EAS command that writes the EAS bit to FRAM. The data rate in the response is twice as defined in ISO/IEC 15693.

The transponder performs verification after writing and returns an error code if the writing has failed.

The EAS bit must be set to "00H" to cancel anti-theft or goods-monitoring mode. The bit must be set to "01H" to set up the goods-monitoring mode.

If the Option\_flag (bit 7) is "0", the transponder shall return its response when it has completed the write operation starting after  $\langle t1_{nom} + \text{a multiple of } 4096/f_c (302.1 \mu\text{s}) \rangle$  with total tolerance of  $\pm 32/f_c (2.4 \mu\text{s})$  and latest within 20 ms. If it is "1", transponder shall wait for the reception of an EOF from the reader/writer and upon such reception still return its response (However, if an EOF is not sent within 38 ms, the time-out error occurs and the transponder can receive another command) .

- Request

[Request from the reader/writer to the transponder]

SOF	Flag	Command (Fast Write EAS)	IC manufacturer code (necessary)	UID (Addressed mode)	Data	CRC	EOF
	8 bits	8 bits ("D1H")	8 bits ("08H")	64 bits	8 bits ("00H" or "01H")	16 bits	

- Response

[Response from the transponder to the reader/writer]

(1) When Error\_flag set

SOF	Flag	Error code	CRC	EOF
	8 bits ("01H")	8 bits	16 bits	

(2) When Error\_flag not set

SOF	Flag	CRC	EOF
	8 bits ("00H")	16 bits	

## 3-10. Fast Read Multiple Blocks Unlimited Command

The Fast Read Multiple Blocks Unlimited command is the same as the Read Multiple Blocks Unlimited command that reads the data of the specified successive blocks.

Up to 256 blocks of data can be read for one request. The data rate in the response is twice as defined in ISO/IEC 15693.

If the Option\_flag (bit 7) is "1", the transponder adds block security status information in the response. If the Option\_flag (bit 7) is "0", the transponder returns only the data in the specified blocks to the reader/writer.

The value of the "number of blocks" field specified in the request is the expected number of blocks minus 1.

Setting the number of blocks to "06H" makes a request to read 7 blocks. Up to "FFH" blocks can be set. (Note that the maximum number of blocks is changed by setting the leading block number.)

- Request

[Request from the reader/writer to the transponder]

SOF	Flag	Command (Fast Read Multiple Blocks Unlimited)	IC manufacturer code (necessary)	UID (Addressed mode)	First block number	Number of blocks	CRC	EOF
	8 bits	8 bits ("D5H")	8 bits ("08H")	64 bits	8 bits	8 bits	16 bits	

- Response

[Response from the transponder to the reader/writer]

(1) When Error\_flag set

SOF	Flag	Error code	CRC	EOF
	8 bits ("01 <sub>H</sub> ")	8 bits	16 bits	

(2) When Error\_flag not set

SOF	Flag	Block security status (option)	Data	CRC	EOF
	8 bits ("00 <sub>H</sub> ")	8 bits	64 bits	16 bits	
Repeated as required					

## 4. Command Execution Time

### 4-1. Write Multiple Blocks Command Execution Time

The minimum time (processing in the addressed mode) required to complete data writing to all user areas (2000 bytes) of the FRAM and verification with the Write Multiple Blocks command is estimated to be 1.4 seconds.

### 4-2. Read Multiple Blocks Command Execution Time

The minimum time (processing in the addressed mode) required to complete data reading for all user areas (2000 bytes) of the FRAM with the Read Multiple Blocks command is estimated to be 1.5 seconds.

In addition, with the Fast Read Multiple Blocks command is estimated to be 1.1 seconds, and with the Fast Read Multiple Blocks Unlimited command is estimated to be 0.35 seconds.

# MB89R118

## STATE TRANSITION DIAGRAM

### • Definition of states

Each state of MB89R118 is defined as follows.

- Power-Off the state : In the power-off state, a transponder cannot fulfill the function so that the voltage from a reader/writer is underpowered.
- Ready state : In the ready state, the MB89R118 can execute all commands if the Select\_flag is not set.
- Quiet state : In the quiet state, the MB89R118 can execute the command for which the Inventory\_flag is not set and the Address\_flag is set.
- Select state : In the select state, the MB89R118 can execute the command for which the Select\_flag is set.

As shown in figure below, the MB89R118 moves from one state to another according to the status of power and by a command.

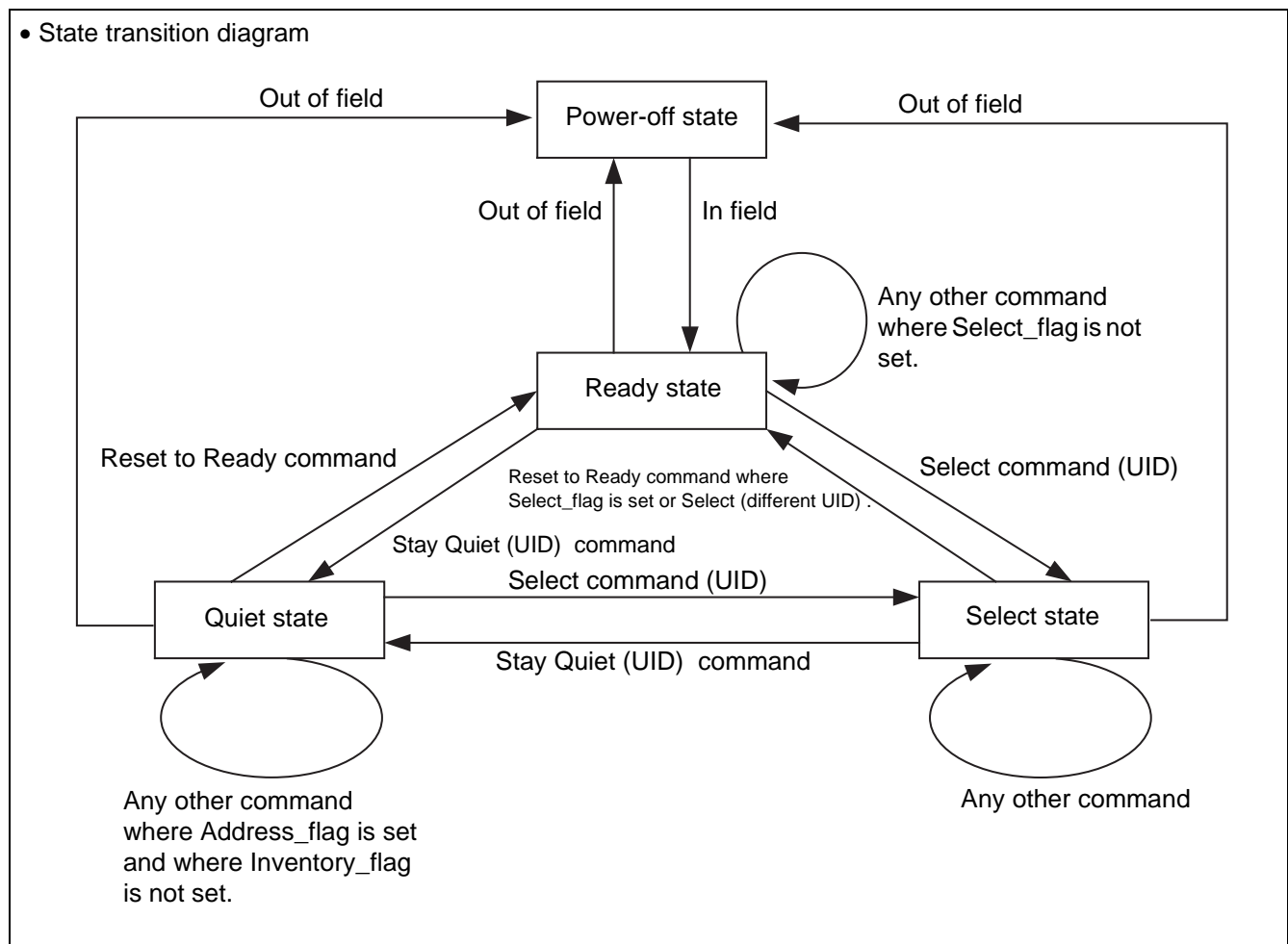



## ■ ABSOLUTE MAXIMUM RATINGS

Parameter	Symbol	Ratings		Unit	Remarks
		Min	Max		
Maximum antenna input current	I <sub>max</sub>	—	90	mA <sub>p-p</sub>	
ESD voltage immunity	V <sub>ESD</sub>	± 2	—	kV	Human body model
Storage temperature	T <sub>stg</sub>	- 40	+ 85	°C	

WARNING: Semiconductor devices can be permanently damaged by application of stress (voltage, current, temperature, etc.) in excess of absolute maximum ratings. Do not exceed these ratings.

## ■ RECOMMENDED OPERATING CONDITIONS

Parameter	Symbol	Value			Unit	Remarks
		Min	Typ	Max		
Minimum antenna input voltage	V <sub>RF</sub>	—	8.7	11.2	V <sub>p-p</sub>	
Antenna input current	I <sub>RF</sub>	—	—	30	mArms	
ASK modulation index	m	10	—	20	%	
ASK pulse width	t1	6.0	—	9.44	μs	
	t2	4.7	—	t1	μs	
	t3	0	—	3.0	μs	
Input frequency	F <sub>in</sub>	13.553	13.560	13.567	MHz	
Operating temperature	T <sub>a</sub>	- 20	—	+ 85	°C	

WARNING: The recommended operating conditions are required in order to ensure the normal operation of the semiconductor device. All of the device's electrical characteristics are warranted when the device is operated within these ranges.

Always use semiconductor devices within their recommended operating condition ranges. Operation outside these ranges may adversely affect reliability and could result in device failure.

No warranty is made with respect to uses, operating conditions, or combinations not represented on the data sheet. Users considering application outside the listed conditions are advised to contact their representatives beforehand.

## ■ ELECTRICAL CHARACTERISTICS

### DC characteristics

Parameter	Symbol	Value			Unit	Remarks
		Min	Typ	Max		
Internal power supply voltage	VDP3	2.7	3.1	3.6	V	
Load modulation resistance	R <sub>ISW</sub>	—	1.1	—	kΩ	
Input capacitance*	C <sub>ant</sub>	22.8	24.0	25.2	pF	Voltage between antennas = 2 V <sub>rms</sub>

\* : Values are controlled by process monitoring in the wafer.

## ■ NOTES ON USING

### • Notes on the radio interface

- It is the user's responsibility to reduce the effects of the electromagnetic waves produced by the reader/writer.
- The user must optimize the shapes of the antenna coils for transponder and reader/writer so that they match the transmission distance and installation space required for the user's application.
- If the user intends to access multiple transponders from a reader/writer, the interference between transponders or between the reader/writer and a transponder may degrade communication performance (transmission distance and communication time) . Therefore, a user who intends to design a system using multiple transponders should consider this point.

### • FRAM reliability

Up to  $10^{10}$  writes to the FRAM memory and 10 years of data retention at  $T_a = 0\text{ }^{\circ}\text{C}$  to  $+55\text{ }^{\circ}\text{C}$  are guaranteed. For the data retention characteristics of the mounting temperature at  $+150\text{ }^{\circ}\text{C}$  or higher, refer to “■ SHIPPING METHOD AND RECOMMENDED ASSEMBLY CONDITIONS”.

### • Difference between rating of ISO/IEC 15693 and MB89R118 implementation.

The table comparing rating of ISO/IEC 15693 to method of MB89R118 is shown in following.

Note that the MB89R118 implementation does not support following ratings.

- 100% amplitude shift keying (ASK) modulation method
- 1 out of 256 mode data coding
- 2-subcarrier
- Supports more than 3 blocks for Read/Write Multiple Blocks command (If “Read/Write Multiple Blocks Unlimited command” of Custom commands is used, enables to support more than 3 blocks.)

• Comparison between ratings of ISO/IEC15693 and specification of MB89R118

Parameter	Details	ISO/IEC15693 method	MB89R118 method
Communication method	10% ASK modulation method	Correspondence	Correspondence
	100% ASK modulation method	Correspondence	Not correspondence
Range of modulation rate	(At using of 10% ASK)	10% to 30%	10% to 20%
Data coding	1 out of 256	Correspondence	Not correspondence
	1 out of 4	Correspondence	Correspondence
Subcarrier	1-subcarrier	Correspondence	Correspondence
	2-subcarrier	Correspondence	Not correspondence
Mandatory command	Inventory command	Correspondence	Correspondence
	Stay Quiet command	Correspondence	Correspondence
Optional command	Read Single Block command	Correspondence	Correspondence
	Write Single Block command	Correspondence	Correspondence
	Lock Block command	Correspondence	Correspondence
	Read Multiple Blocks command	Correspondence	Correspondence uppermost 2 blocks
	Write Multiple Blocks command	Correspondence	Correspondence uppermost 2 blocks
	Select command	Correspondence	Correspondence
	Reset to Ready command	Correspondence	Correspondence
	Write AFI command	Correspondence	Correspondence
	Lock AFI command	Correspondence	Correspondence
	Write DSFID command	Correspondence	Correspondence
	Lock DSFID command	Correspondence	Correspondence
	Get System Information command	Correspondence	Correspondence
	Get Multiple Block Security Status command	Correspondence	Correspondence

# MB89R118

## ■ SHIPPING METHOD AND RECOMMENDED ASSEMBLY CONDITIONS

### • Shipping method

The following shows shipping method and ordering information for the MB89R118. Please inquire separately for the details.

Part no.	Wafer thickness	Tip dicing	Shipping method
MB89R118A-DI15	150 $\mu\text{m} \pm 25.4 \mu\text{m}$	Completed	Wafer shipping (Mount gold-plated bump in antenna terminal etc.)

### • Recommended assembly conditions

The MB89R118 is recommended to be mounted in the following condition to maintain the data retention characteristics of the FRAM memory when the chip is mounted.

- Mounting temperature of + 175 °C or lower, and 120 minutes or shorter when applied at high temperature, or
- Mounting temperature of + 200 °C or lower, and 60 seconds or shorter when applied at high temperature

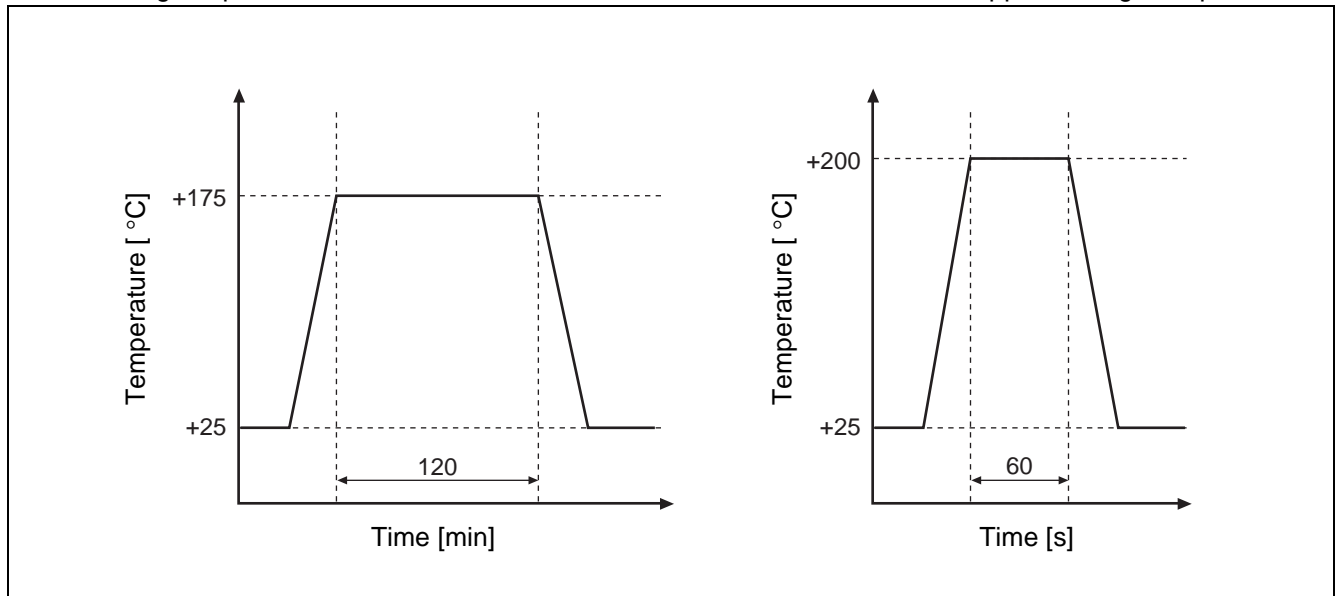

**MEMO**

**MEMO**



**MEMO**

# FUJITSU MICROELECTRONICS LIMITED

Shinjuku Dai-Ichi Seimei Bldg. 7-1, Nishishinjuku 2-chome, Shinjuku-ku,  
Tokyo 163-0722, Japan Tel: +81-3-5322-3347 Fax: +81-3-5322-3387  
<http://jp.fujitsu.com/fml/en/>

*For further information please contact:*

## **North and South America**

FUJITSU MICROELECTRONICS AMERICA, INC.  
1250 E. Arques Avenue, M/S 333  
Sunnyvale, CA 94085-5401, U.S.A.  
Tel: +1-408-737-5600 Fax: +1-408-737-5999  
<http://www.fma.fujitsu.com/>

## **Europe**

FUJITSU MICROELECTRONICS EUROPE GmbH  
Pittlerstrasse 47, 63225 Langen,  
Germany  
Tel: +49-6103-690-0 Fax: +49-6103-690-122  
<http://emea.fujitsu.com/microelectronics/>

## **Korea**

FUJITSU MICROELECTRONICS KOREA LTD.  
206 KOSMO TOWER, 1002 Daechi-Dong,  
Kangnam-Gu, Seoul 135-280  
Korea  
Tel: +82-2-3484-7100 Fax: +82-2-3484-7111  
<http://www.fmk.fujitsu.com/>

## **Asia Pacific**

FUJITSU MICROELECTRONICS ASIA PTE LTD.  
151 Lorong Chuan, #05-08 New Tech Park,  
Singapore 556741  
Tel: +65-6281-0770 Fax: +65-6281-0220  
<http://www.fujitsu.com/sg/services/micro/semiconductor/>

FUJITSU MICROELECTRONICS SHANGHAI CO., LTD.  
Rm.3102, Bund Center, No.222 Yan An Road(E),  
Shanghai 200002, China  
Tel: +86-21-6335-1560 Fax: +86-21-6335-1605  
<http://cn.fujitsu.com/fmc/>

FUJITSU MICROELECTRONICS PACIFIC ASIA LTD.  
10/F., World Commerce Centre, 11 Canton Road  
Tsimshatsui, Kowloon  
Hong Kong  
Tel: +852-2377-0226 Fax: +852-2376-3269  
<http://cn.fujitsu.com/fmc/tw>

All Rights Reserved.

The contents of this document are subject to change without notice.

Customers are advised to consult with sales representatives before ordering.

The information, such as descriptions of function and application circuit examples, in this document are presented solely for the purpose of reference to show examples of operations and uses of FUJITSU MICROELECTRONICS device; FUJITSU MICROELECTRONICS does not warrant proper operation of the device with respect to use based on such information. When you develop equipment incorporating the device based on such information, you must assume any responsibility arising out of such use of the information.

FUJITSU MICROELECTRONICS assumes no liability for any damages whatsoever arising out of the use of the information.

Any information in this document, including descriptions of function and schematic diagrams, shall not be construed as license of the use or exercise of any intellectual property right, such as patent right or copyright, or any other right of FUJITSU MICROELECTRONICS or any third party or does FUJITSU MICROELECTRONICS warrant non-infringement of any third-party's intellectual property right or other right by using such information. FUJITSU MICROELECTRONICS assumes no liability for any infringement of the intellectual property rights or other rights of third parties which would result from the use of information contained herein.

The products described in this document are designed, developed and manufactured as contemplated for general use, including without limitation, ordinary industrial use, general office use, personal use, and household use, but are not designed, developed and manufactured as contemplated (1) for use accompanying fatal risks or dangers that, unless extremely high safety is secured, could have a serious effect to the public, and could lead directly to death, personal injury, severe physical damage or other loss (i.e., nuclear reaction control in nuclear facility, aircraft flight control, air traffic control, mass transport control, medical life support system, missile launch control in weapon system), or (2) for use requiring extremely high reliability (i.e., submersible repeater and artificial satellite).

Please note that FUJITSU MICROELECTRONICS will not be liable against you and/or any third party for any claims or damages arising in connection with above-mentioned uses of the products.

Any semiconductor devices have an inherent chance of failure. You must protect against injury, damage or loss from such failures by incorporating safety design measures into your facility and equipment such as redundancy, fire protection, and prevention of over-current levels and other abnormal operating conditions.

Exportation/release of any products described in this document may require necessary procedures in accordance with the regulations of the Foreign Exchange and Foreign Trade Control Law of Japan and/or US export control laws.

The company names and brand names herein are the trademarks or registered trademarks of their respective owners.