



FEATURES

- RoHS compliant
- Compact size, low profile
- Surface mount design
- Inductance range from 1.0 μ H to 3.3mH
- Tape & reel packaging
- UL 94V-0
- Custom solutions available

PRODUCT OVERVIEW

The 2800 series is a range of bobbin-wound, surface-mount inductors designed for use in switching power supply, and power line filter circuits. The parts are suitable for any application requiring a high saturation current in a miniature surface-mount footprint.

SELECTION GUIDE

Order Code	Inductance (1kHz, 100mVAC)	Inductance Range (1kHz, 100mVAC)	DC Current ²	DC Resistance	Q@f MHz		SRF
	Nom.	Min.-Max.	Max.	Max.	Nom.		Typical
	μ H	μ H	A	m Ω	Q	F	MHz
28102C	1.0	0.68 - 1.02	15.5	2.6	45.6	1.0	104
28152C	1.5	1.12 - 1.68	12.5	3.6	43.9	1.0	72
28222C	2.2	1.56 - 2.34	11.2	4.4	36.9	1.0	58
28332C	3.3	2.84 - 4.26	9.3	7.5	34.6	1.0	42
28472C	4.7	3.68 - 5.52	8.3	10	33.3	1.0	37
28682C	6.8	5.52 - 8.28	6.8	14	31.2	1.0	29
28103C	10	7.84 - 11.76	5.9	18	31.1	1.0	22.5
28153C	15	12.0 - 18.0	4.77	28	31.0	1.0	17.8
28223C	22	17.7 - 26.5	3.85	42	43.5	1.0	14.4
28333C	33	26.2 - 39.4	3.22	63	42.8	1.0	11.8
28473C	47	39.0 - 58.4	2.66	86	31.5	1.0	10.4
28683C	68	55.4 - 83.0	2.16	122	33.9	1.0	8.6
28104C	100	80.8 - 121.2	1.80	174	21.4	0.8	7.7
28154C	150	121 - 181	1.40	276	20.9	0.8	6.7
28224C	220	178 - 266	1.20	381	18.0	0.8	5.8
28334C	330	266 - 398	0.95	575	30.8	0.8	5.0
28474C	470	383 - 575	0.78	816	31.7	0.8	4.3
28684C	680	548 - 822	0.64	1170	20.4	0.8	4.2
28105C	1000	940 - 1150	0.51	1820	21.0	0.8	3.8
28155C	1500	1390 - 1700	0.41	2620	19.8	0.8	3.4
28225C	2200	1960 - 2400	0.35	3720	15.8	0.8	3.3
28335C	3300	3030 - 3700	0.29	5760	12.8	0.8	3.2

ABSOLUTE MAXIMUM RATINGS

Operating free air temperature range	-40°C to 125°C
Storage temperature range	-40°C to 150°C

SOLDERING INFORMATION¹

Peak reflow solder temperature	245°C
Pin finish	Tin

PACKAGE SPECIFICATIONS

Mechanical Dimensions

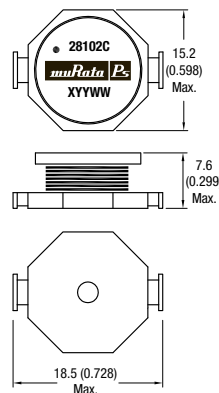

Package weight: 3.9g Typ.
All dimensions in mm (inches)
Dot signifies the innermost turn of the winding

Recommended Footprint Details

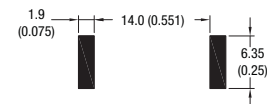

Specifications typical at $T_A = 25^\circ\text{C}$

- 1 For further information, please visit www.murata-ps.com/rohs
- 2 The maximum DC current is the value at which the inductance falls to 75% of its nominal value or when its temperature rise reaches 40°C, whichever is sooner.



INDUCTANCE Vs CURRENT

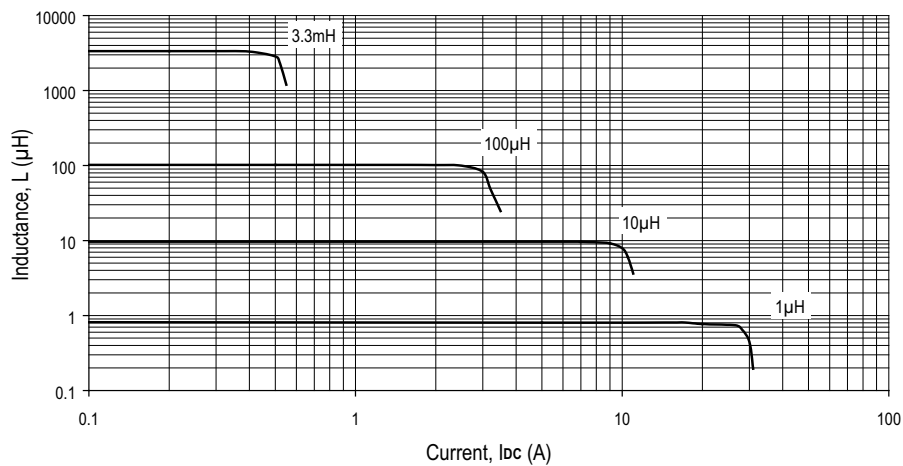

TEMPERATURE Vs CURRENT

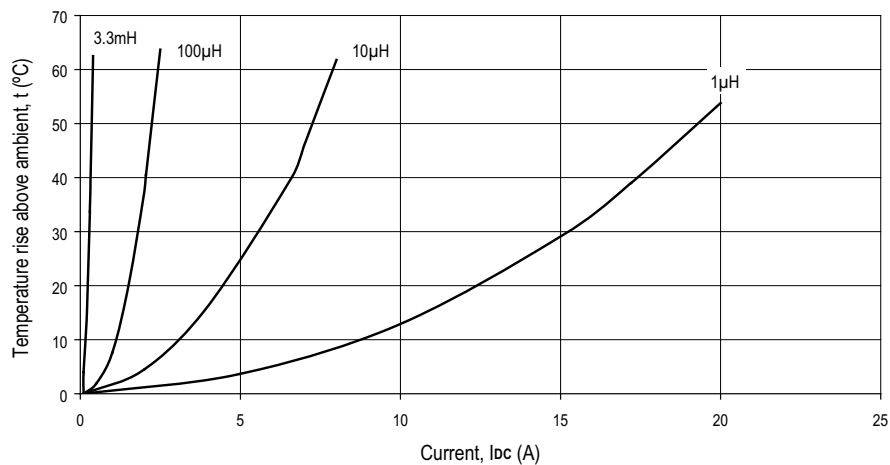

INDUCTANCE Vs FREQUENCY

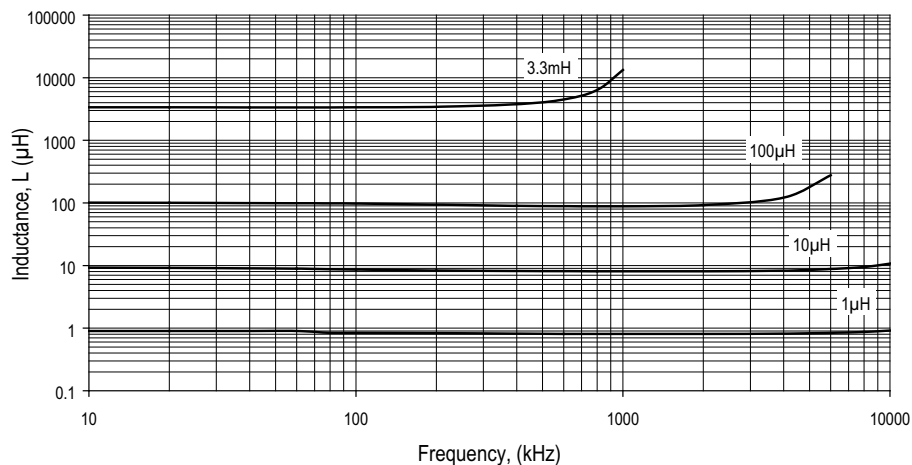

PACKAGE SPECIFICATIONS

Mechanical Dimensions

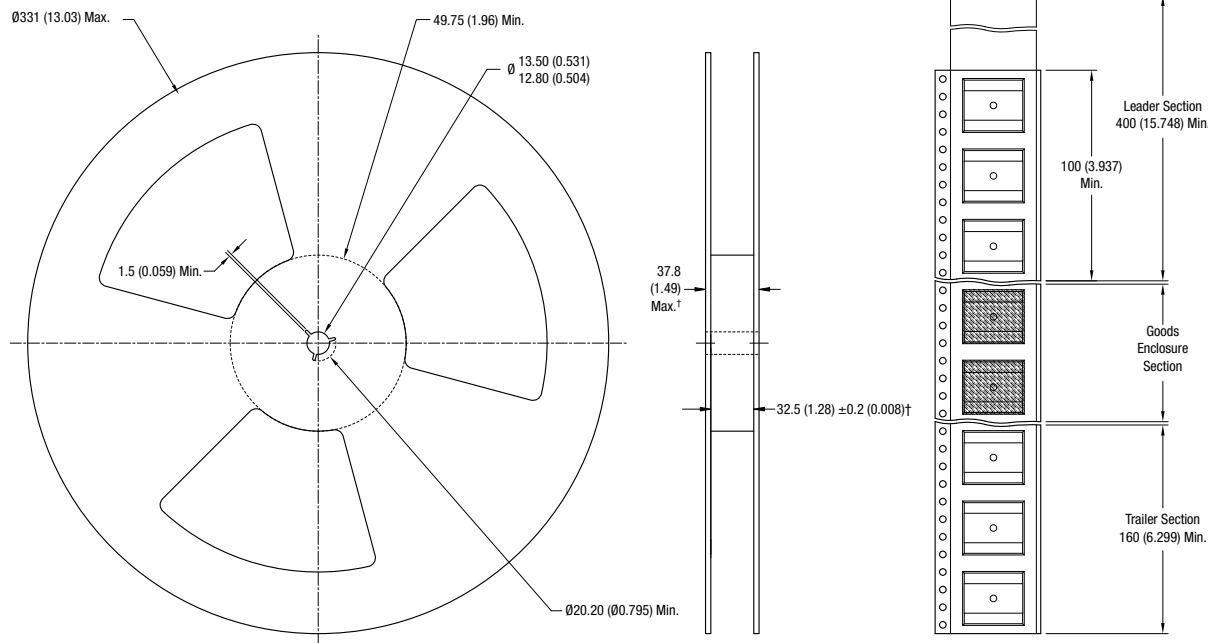

All dimension in mm (inches)
† Measured at hub

Tape Outline Dimensions

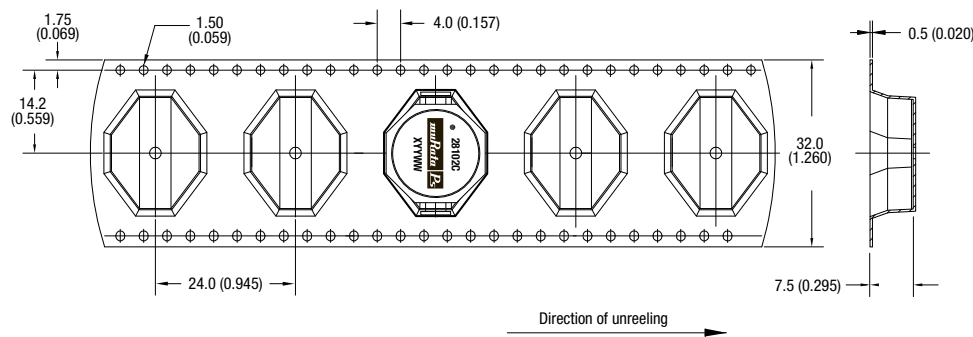

Reel quantity: 350
All dimensions in mm (inches)